



ART AND ARCHITECTURE
IN THE ISLAMIC
TRADITION

AESTHETICS, POLITICS AND
DESIRE IN EARLY ISLAM

MOHAMMED HAMDOUNI ALAMI

I.B.TAURIS

Mohammed Hamdouni Alami, DPLG, Ph.D., studied architecture at the Ecole d'Architecture in Grenoble and was awarded a doctorate from the University of California, Berkeley. He is presently an associate researcher at the University of California, Berkeley.

LIBRARY OF MODERN MIDDLE EAST STUDIES

Series ISBN: 978 1 84885 243 3

See www.ibtauris.com/LMMES for a full list of titles

92. *Orientalism and Conspiracy: Politics and Conspiracy Theory in the Islamic World*
Arndt Graf, Schirin Fathi and Ludwig Paul (Eds)
978 1 84885 414 7
93. *Honour Killings: International Human Rights and Crimes Against Women in Turkey*
Leylâ Pervizat
978 1 84885 421 5
94. *Gender and Identity in North Africa: Postcolonialism and Feminism in Maghrebi Women's Literature*
Abdelkader Cheref
978 1 84885 449 9
95. *Kurds of Modern Turkey: Migration, Neoliberalism and Exclusion in Turkish Society*
Cenk Saraçoğlu
978 1 84885 468 0
96. *Occidentalisms in the Arab World: Ideology and Images of the West in the Egyptian Media*
Robbert Woltering
978 1 84885 476 5
97. *The Army and the Radical Left in Turkey: Military Coups, Socialist Revolution and Kemalism*
Özgür Mutlu Ulu
978 1 84885 484 0
98. *Power and Policy in Syria: Intelligence Services, Foreign Relations and Democracy in the Modern Middle East*
Radwan Ziadeh
978 1 84885 434 5
99. *The Copts of Egypt: The Challenges of Modernisation and Identity*
Vivian Ibrahim
978 1 84885 499 4
100. *The Kurds of Iraq: Ethnonationalism and National Identity in Iraqi Kurdistan*
Mahir Aziz
978 1 84885 546 5
101. *The Politics and Practices of Cultural Heritage in the Middle East: Positioning the Material Past in Contemporary Societies*
Irene Maffi and Rami Daher (Eds)
978 1 84885 535 9
102. *The Politics and Poetics of Ameen Ribani: The Humanist Ideology of an Arab-American Intellectual and Activist*
Nijmeh Hajjar
978 1 84885 266 2
103. *The Transformation of Turkey: Redefining State and Society from the Ottoman Empire to the Modern Era*
Fatma Müge Göçek
978 1 84885 611 0

ART AND ARCHITECTURE IN
THE ISLAMIC TRADITION

Aesthetics, Politics and Desire in Early Islam

MOHAMMED HAMDOUNI ALAMI

I.B. TAURIS

LONDON · NEW YORK

Published in 2011 by I.B.Tauris & Co Ltd
6 Salem Road, London W2 4BU
175 Fifth Avenue, New York NY 10010
www.ibtauris.com

Distributed in the United States and Canada Exclusively by
Palgrave Macmillan, 175 Fifth Avenue, New York NY 10010

Copyright © 2011 Mohammed Hamdouni Alami

The right of Mohammed Hamdouni Alami to be identified as the author of this work has been asserted by the author in accordance with the Copyright, Designs and Patent Act 1988.

All rights reserved. Except for brief quotations in a review, this book, or any part thereof, may not be reproduced, stored in or introduced into a retrieval system, or transmitted, in any form or by any means, electronic, mechanical, photocopying, recording or otherwise, without the prior written permission of the publisher.

ISBN: 978 1 84885 544 1

Library of Modern Middle East Studies 104

A full CIP record for this book is available from the British Library
A full CIP record for this book is available from the Library of Congress

Library of Congress catalog card: available

Printed and bound in Great Britain by CPI Antony Rowe
Camera-ready copy edited and supplied by Oxford Publishing Services, Oxford

FOR SERGIO FERRO

Contents

Illustrations	ix
Arabic Characters	xii
Acknowledgements	xiii
1. Introduction	1
<i>Architecture and Poetics</i>	16
<i>The Aims of this Book</i>	27
2. Architecture and Meaning in the Theory of al-Jāḥiẓ	33
<i>Architecture and Meaning: Al-Jāḥiẓ's View</i>	38
<i>Aesthetic, Variety and Emotion</i>	47
<i>Voice, Body and Emotion</i>	48
<i>Al-Bayān, Architecture and Commemoration</i>	55
3. Architecture and Poetics	63
<i>Modus Operandi</i>	66
<i>Al-Khalil's Theory of Language</i>	70
<i>Arabic Poetics</i>	74
<i>The Palace and the Qaṣīda</i>	121
4. Architecture and Myth	129
<i>Ḥadīthu Sinimmār</i>	129
5. Al-Jāḥiẓ in the Mosque at Damascus: Social Critique and Debate in the History of Umayyad Architecture	159
<i>Yaḡubi's Account</i>	164
<i>Muḡaddasi's Account</i>	164
<i>Architecture and Hospitality</i>	171
<i>'Umar II: Architecture and Piety</i>	178
6. Architecture and Desire	189
<i>'Architects' or Architectural Planners</i>	192
<i>The Desire for Architecture</i>	201
<i>Architecture and Misrecognition</i>	212

ART AND ARCHITECTURE IN THE ISLAMIC TRADITION

<i>The Travelling Gaze: Ibn al-Jahm's Eulogy of the Palace</i>	214
al-Haruni	224
<i>Building, Reflection and Emptiness</i>	227
7. Conclusion	235
Notes	269
References	281
Index	

Illustrations

Figures in text

1. Panel with stylized bird, Egypt, ninth–tenth century CE.
Pinewood, H. 0.73m x W. 0.32m. Paris, Louvre Museum,
inv. 6023. (© Réunion des Musées Nationaux/
Art Resource, NY) 92
2. (a) Marble window grille, Great Mosque at Damascus
(b) Geometric analysis of window grille (after
K. A. C. Creswell, *A Short Account of Muslim Architecture*) 97
3. Mshatta palace, (a) plan, (b) diagram of successive sub-
division (after K. A. C. Creswell, *Early Muslim Architecture*) 101
4. Qasr at-Tuba, (a) plan, (b) diagram (after K. A. C. Creswell,
Early Muslim Architecture) 102
5. Balkh, Nine Bay Mosque, (a) plan, (b) diagram
(after Oleg Grabar, *The Formation of Islamic Art*) 103
6. Ukhaidir Palace plan
(after K. A. C. Creswell, *Early Muslim Architecture*) 104
7. The Great Mosque at Damascus (a) plan, (b) diagram
(after K. A. C. Creswell, *Early Muslim Architecture*) 106
8. Qayrawān, mosque plan
(after Oleg Grabar, *The Formation of Islamic Art*) 110
9. Samarra, the Mosque of Abu Dulaf
(after K. A. C. Creswell, *Early Muslim Architecture*) 111
10. (a) Samarra, the Great Mosque plan 112
(b) Samarra, the Great Mosque diagram
(after K. A. C. Creswell, *Early Muslim Architecture*) 113
11. Cairo, the Mosque of Ibn Tulun (a) plan, (b) diagram
(after K. A. C. Creswell, *Early Muslim Architecture*) 115
12. Madinat al-Zahra, Great Mosque
(after Robert Hillenbrand, *Islamic Architecture*) 116
13. Córdoba, the Great Mosque plan
(after John Hoag, *Islamic Architecture*) 118

14. Cairo, the Mosque of al-Ḥākīm (after John Hoag, <i>Islamic Architecture</i>)	120
15. Samarra, the Balkuwara Palace, plan (after K. A. C. Creswell, <i>Early Muslim Architecture</i>)	122
16. The Dome of the Rock, Jerusalem, axonometric view (after Auguste Choisy, <i>Histoire de l'Architecture</i>)	125
17. Susa: the Ribat, (a) plan, (b) diagram (after K. A. C. Creswell, <i>Early Muslim Architecture</i>)	127
18. Khirbat Minyah, plan (after Oleg Grabar, <i>The Formation of Islamic Art</i>)	127

Plate Section

1. The Great Mosque of Damascus, façade
2. The Great Mosque of Damascus, bayt al-mal
3. Detail of mosaic of bayt al-mal, Great Mosque at Damascus
4. The Dome of the Rock, Jerusalem
5. Qasr al-Hair west: entrance, now in Damascus National Museum
6. Mshatta, detail of façade, now in Berlin (courtesy of the Museum für Islamische Kunst/Staatliche Kunst zu Berlin)
7. Wall revetment from a private house, Iraq (Samarra) ninth-century CE. Carved stucco, bevelled style, H. 1.30m x W. 2.25m, Museum für Islamische Kunst, Berlin, Inv. No. 3467 (courtesy of the Museum für Islamische Kunst/Staatliche Kunst zu Berlin)
8. Birds, detail of painting, Samarra (reconstitution by Ernst Herzfeld, *Die Malereien von Samarra*, 1927)
9. Lady with master's signature (reconstitution by Ernst Herzfeld, *Die Malereien von Samarra*, 1927)
10. Two dancers, wall painting, Samarra, CE 836–39 (reconstitution by Ernst Herzfeld, *Die Malereien von Samarra*, 1927)
11. A huntress, wall painting, Samarra, CE 836–39 (reconstitution by Ernst Herzfeld, *Die Malereien von Samarra*, 1927)
12. Cairo, the Mosque of Ibn Tulun, view from the prayer hall toward the sahn
13. Cairo, the Mosque of Ibn Tulun, prayer hall
14. Cairo, the Mosque of Ibn Tulun, view from the riwaq toward the minaret
15. Cairo, the Mosque of Ibn Tulun, view of the ziyada

ILLUSTRATIONS

16. Abu Zaid, *Maqāmāt of al-Harīrī*, second quarter of the thirteenth century, Paris, Bibliothèque Nationale de France, Ms Arabe 3929, folio 69 recto (© Bibliothèque Nationale de France)
17. Two horsemen, Iraq CE 1210 (*Kitāb al-Bayṭara*). Istanbul, Library of the Topkapi Sarayi Museum, Ahmet III, 2115, folio 57 verso (© Topkapi Sarayi Museum)
18. *Book of the Knowledge of Mechanical Devices* by Abul Izz Ismail al-Jazari, fourteenth-century CE, copyist Farkh Ibn Abd al-Latif. Ink, colours and gold on paper (H. 30cm x 7 cm). Bequest of Legs Cora Timken Burnett, 1956 (57.51.23). The Metropolitan Museum of Art, New York, NY, USA (©Metropolitan Museum of Art/Art Resource, NY)

Arabic Characters

ء	ﺀ	ض	ḍ
ب	b	ط	ṭ
ت	t	ظ	ẓ
ث	th	ع	‘
ج	j	غ	gh
ح	ḥ	ف	f
خ	kh	ق	q
د	d	ك	k
ذ	dh	ل	l
ر	r	م	m
ز	z	ن	n
س	s	ه	h
ش	sh	و	w
ص	ṣ	ي	y

ة (at in contracted state)
 ال (article) al- and l-

Long vowels

اى	ā
و	ū
ي	ī

Short vowels

اَ	a
وُ	u
يَ	i

Acknowledgements

Many people have contributed to this work in a variety of ways. I would like to thank in particular:

David Stronach for his unfailing and affectionate support, his detailed readings of my manuscript, and his insightful comments. He will remain for me a model of intellectual modesty, rigour and insight.

Finbarr Barry Flood and Jocelyne Dakhliya for their minute reading of the manuscript, and insightful and enriching remarks.

Margaret Larkin, Etel Adnane, Simone Fattal, Ramona Naddaf, Hayani Bouchta, El Hannaoui Mohammed, Vyjayanthi Rao and Nizar al-Sayyad for their friendly support and enriching remarks.

Beshara Doumani for his friendship, and his comments. Timothy Mitchell, for his friendship and enriching discussions over the years.

Cherif Kebbal, Christopher Polk, Meg Conkey, Rosemary Joyce, Luca D'Isanto, Charles Hirschkind, Veena Das, Samera Esmeir and Mary Murrel for their support and encouragement.

Abdelahad Sebti, Khalid Mosalam, Mary Comerio, Yazid Hamdouni Alami, Jaouad Alami Drideb, Hadj Mohamed Chami, Jaouad Kadiri, the late Mostafa Lemaamer, Mohamed Chebaa and Mohamed Ben Jaafar Marrakchi for encouraging me in such a friendly manner to undertake this project.

Margaret Henderson, Linda Pritcher and Jenna Rice for their precious help with editing the manuscript. Stefania Pandolfo, for her constant support and critical engagement.

Yassine, my son for his loving smile, and encouragement. Selina Cohen for editing and typesetting the book, and Jenna Steventon for her enthusiastic support.

This work was partially funded by a grant from the Al-Falah Program of the Center for Middle Eastern Studies, University of California at Berkeley.

1

Introduction

We must look for the ways in which a given epoch solved for itself aesthetic problems as they presented themselves at the time to the sensibilities and the culture of its people. Then our historical inquiries will be a contribution, not to whatever we conceive 'aesthetic' to be, but rather to the history of a specific civilization, from the standpoint of its own sensibility and its own aesthetic consciousness.

(Umberto Eco)¹

In the mid-1980s, the rabbi of Rabat, Morocco, having decided to restore the old synagogue of the city, commissioned a local architect to carry out the restoration project and asked him to present his very best ideas. The architect, a young Muslim with little knowledge of traditional Moroccan Jewish customs, was eager to do his best, and prepared a few sketches based on his estimation of what would please the rabbi. When the rabbi was presented with the architectural drawings and their modernist approach, he could not help showing his disappointment, and told the Muslim architect:

My son, the community of the faithful will be disappointed by these bare spaces you are proposing, for we Jewish people, too, love ornament, stucco, plaster, woodwork, and all that. Our people, like yours, like their spaces of worship to be richly decorated. That is how we like our synagogues.²

The young Muslim architect who told me this story was taken aback for, like most of his Muslim compatriots, he did not

imagine that Moroccan Jews shared with them a taste for architectural ornament. Yet one need simply visit a few traditional Jewish homes in Rabat or Fes to recognize the similarity in taste. Although the existence of this similarity is not, in itself, extraordinary, this anecdote has always had the most amazing effect on my students in Morocco, for there is a strong belief that traditional ornament is Islamic, has an Islamic content, and must therefore be foreign to Jewish, among other, traditions. That belief, in both its overt and covert forms, is in fact very widespread in and outside Morocco, and it seems to me that academic scholarship is partially responsible for this.

This is why I believe that until more conclusive research is conducted we should suspend the use of the term Islamic to qualify the architecture of the Islamic world after the rise of Islam. As the anecdote above suggests, what has been called 'Islamic architecture' has little if any religious content. The elaboration of the architectural types at hand appears to have been a complex synthesis of different legacies, and cultural and political statements as well. As Oleg Grabar pointed out, the role of the new faith seems to have been limited to a few features, such as the ban on the representation of living beings in religious buildings, the appearance of the house of the prophet and his pulpit, and the requirements related to the form of the ritual prayer in the organization of the mosque.³ The Qur'an, which is the original source of Islamic religious knowledge, does not contain any doctrine of the arts. The traditions of the prophet that are related to the ban of images date to the eighth century and are later than the formation of the basic architectural typologies.

Even commemorative structures do not have, against all expectations, any religious basis, as exemplified by the Taj Mahal, the most celebrated among such structures, a monument dedicated by a prince to his beloved deceased wife. As Robert Hillenbrand⁴ argued, the geographic extension of the Islamic world, the assimilation of different cultures, and the consequent formation of regional styles that are very different from each other (Ottoman, Moghul, Andalusian, Syrian and Iranian) plead against any trans-historical definition of this fundamentally

diverse architectural corpus. We should, in fact, consider this diversity in the same way as we view Gothic, Renaissance, Baroque and other architectural legacies of Europe as different forms in European architectural history.

Furthermore, we should keep in mind that the history of the Islamic world bears witness to a constant and reciprocal flux of exchanges and influences with other civilizations. Thus, for instance, Umayyad architecture, albeit the product of an Islamic society, may appear to bear a closer kinship to Byzantine art than to the Safavid architecture of Iran; and the Romanesque architecture of southern France, despite its European character, may appear closer to Moorish art than to Rococo architecture.

It is also well known that the Umayyad Mosque in Damascus has been mistakenly thought of as a converted Byzantine church,⁵ and that still today some Islamists condemn Umayyad architecture as being Christian in inspiration. I will therefore restrict myself to use the dynastic appellations of the different styles, and following K. A. C. Creswell I will refer to the formative period of the architecture of the Islamic world as that of early Islam, which would include the Umayyad and the 'Abbasid styles.

The Stakes of the Present

In this book I discuss the common belief that the art and architecture of the Islamic world have a fundamentally Islamic content, and endeavour to show how even scholarly debates about that art and architecture are often framed within a set of theoretical considerations that are no longer relevant given new approaches to the study of art. The reflections and reassessments I pursue in the following chapters stem from an awareness that the history of the art and architecture of the Islamic world has hitherto remained confined to a limited circle of the initiated, and that such isolation from the larger milieu of art historians and theoreticians is caused by a certain epistemological imbalance. It is not accidental that among the North American and Western European universities that have departments of art history, only a select few offer courses on the art and architecture of the Islamic world. I believe that to level this imbalance

and to free the history of art and architecture of the Islamic world from its confinement, it is necessary to engage this scholarly field with the types of questions and reflections that animate the larger debates about art and architecture. I am well aware that attempts to do so have already been made, as in the work of Oleg Grabar, *The Mediation of Ornament*.⁶ Indeed, the pages of this book are greatly indebted to Grabar's work, even when critical of his approach or conclusions.⁷

I am convinced that, despite the importance of those attempts, a rift remains unbridged. Perhaps the most significant trait of this discrepancy is the peculiar way in which the majority of scholarly work on the art of the Islamic world revolves around the question of representation: all discussions about the early Islamic community's attitude to the arts, and to Islam in general, are framed within the context of the ban against representing living beings in Islam – and this is evident in the writings of Western and Middle Eastern scholars alike. This tendency is based on a vision of art limited by the classical conception of art as a representation of the human body, one that implies an opposition between the art of the Islamic world, and that of the West.⁸

To tackle this issue Gülru Necipoğlu writes in a remarkably erudite book: 'This binary opposition, grounded in the construction of a sharp dichotomy between abstract pattern-making and mimetic representation in the Western tradition of art, has deeply coloured the literature on the "character" of Islamic art.'⁹ Seeking to overcome this ideological split, and to address what she calls 'the issue of cultural specificity and meaning in a visual tradition that employed repetitive abstract signs', Gülru Necipoğlu advocates the recourse to a 'semiotic framework'. In her perspective that would 'help dissolve the sharp dichotomy between the 'iconographic' and the 'decorative' by investing abstract patterns with a wide range of culturally relevant associations'.¹⁰

I believe, however, that even though the semiotic approach can be fruitful, it does not address the core of the problem, but only circumvents it. For the dichotomy at hand is the result of the very limits of the classical conception of art as a representation of the human body, a bias exposed early in the

twentieth century by the abstract turn in Western modern art. We now know, from Mondrian's grids, Malevich's 'Suprematist Composition: White on White', the constructivist movement, and abstract art in general, that art can be something other than the representation of the human body, that art is not neutral aesthetic contemplation but is fraught with power and violence, and that the presupposition of classical art was not a universal truth but the assumption of a specific cultural and historical set of practices and vocabularies.

Such an approach, limited by the classical conception of art, not only marks the academic fault line between art history and the history of art of the Islamic world, but has precluded a meaningful exploration of the specific Islamic attitudes towards the arts *per se*. The Taliban Edict in February 2001, calling for the destruction of all statues in Afghanistan in the name of an alleged observance of the Shari'a ban on idols (which led to the destruction of the fifth-century buddhas of Bamiyan) revealed how problematic that view is, and was testimony to the urgent need for serious debates about art in Muslim countries.¹¹

In this charged ideological context, one can question the theoretical underpinnings of current debates about reviving or creating an architectural style in the spirit of Islam. My years of architectural practice in Morocco, and teaching in Morocco, France and the United States, have led me to realize that it has become a political responsibility for architects working in the Muslim world to develop a new reflection on the history and formation of the architecture of the Islamic world. In the realm of architecture and urban planning, proponents of the recent Islamic revivalist movement have espoused the need to reroot modern urbanism in an 'original Islamic model'. This has created a sense of urgency among architects practising and teaching in Middle Eastern countries, who do not share this view, to refute stereotypical and idealized representations of what a contemporary local architecture and urbanism inspired by Islamic values might resemble. The fact is that the view advocated by Islamic revivalists – today aggressively promoted in most universities and professional schools – is gaining ever more ground, for there has been no real debate on the post-

colonial, postmodern condition of these societies in scholarly or political circles in the Islamic world.

The near absence of architectural criticism in many Arab and Muslim countries facilitates the largely unquestioned propagation of these views, and has opened the door to superficial speculation about the meaning and identity of art and architecture of the Islamic world. Sometimes to frivolous and politically harmful speculation as, for instance, in Roger Garaudy's *The Mosque, Mirror of Islam* where the space of the mosque is mistakenly presented as decentred, and the 'forest of columns' in the Mosque of Córdoba is described as an illustration of 'the Revelation of the Qur'an'. This interpretation wholly contradicts the well documented history of the building, which shows that the structure was designed to recall the great mosque at Damascus and other Umayyad structures, and that its forest-like character actually resulted from the successive extensions of the building.¹²

In the post-colonial era, architecture became a primary medium in the construction and display of identities in some Arab and Islamic states, for the malaise generated in the West by modern architecture in the 1970s, and the appearance of postmodern approaches was felt in the Arab-Islamic world as well. In Saudi Arabia and the Gulf countries, for instance, urban planners began searching for ways of reproducing earlier urban patterns in modern cities.¹³

In other countries, among them Morocco, the state carried out a policy of urban design and national architecture. At the same time, the Aga Khan Foundation promoted the idea that Muslims should search for specific elements of architectural design based on Islam, and sponsored a series of seminars and publications on this topic.¹⁴ Despite the fact that its cultural activism can lend itself to controversial interpretations, in the sense of identity politics, the Aga Khan programme was a unique opportunity to foster debate on the history of the architecture and urbanism of the Islamic world, and current issues concerning architecture and housing.

All the aforementioned complex ideological and architectural developments have been based on the assumption that architecture was always a formative component of Islamic identity and

culture rather than a simple reflection of that culture. This search for specific ‘Islamic architectural values’ was not limited to Arab-Islamic countries: it was also burgeoning in the West, where Muslim immigrant communities were creating Muslim spaces.¹⁵ Western interest in the revival of an architecture inspired by Islam was neither simply academic nor limited to the relatively small group of Western architects working in Muslim countries. Muslim communities in the West were also seeking to create a symbolic space for Islam through interventions in the built environment. In the Arab-Muslim world, however, this search cannot be said to have brought about a renewal of architectural theory. The debate about art and architecture remained far less developed than that about Western art. In particular, an ‘Orientalist archetype’ remained predominant in the discourse and practice of urbanism, restricting its development to a set of poor and unreconstructed functionalist tropes.¹⁶ Thus, this inherited discourse on the unchanging essence of Muslim space, and the corollary commitment to implementing an ‘Islamic urbanism’, today remain at odds with a critical understanding of history, in the sense that none of the conditions that determined the production of the ‘Islamic cities’ of the past still exists.

The Sense of Ambiguity

The absence of written sources attesting to the existence of a doctrine of the arts in the early Islamic period encourages speculation about the art of that epoch and its meaning. It makes it difficult to criticize such stereotypes as those promoted by the functionalist or Sufi schools of thought, and remains a serious impediment to understanding the formation of the architecture of the Islamic world. Oleg Grabar’s question of whether what we consider to be the distinctive features of the art of early Islamic societies resulted from authorial intention, or from our lack of sufficiently developed criteria of interpretation, still remains unanswered.¹⁷ Grabar states:

The creation of an Islamic art was not the result of an artistic or aesthetic doctrine inspired by the new religion or

even by social or other consequences of the prophetic message, but consisted in transforming preceding traditions compatible with the as yet barely formulated identity of the Muslim community and at times trying to serve its needs or to proclaim its presence (as in the minaret and tiraz).¹⁸

Oleg Grabar also asserts that it is unlikely that these transformations involved an express theoretical reflection or doctrine of the arts. He then supports the hypothesis that these transformations might have been the result of collective consensus, despite the fact that 'a collective process in the choice of forms ... is nearly impossible to demonstrate'.¹⁹ I believe that the very terms of this debate should be reconsidered. Grabar's juxtaposition of a process in which the 'entire community' reached 'a collective consensus' with 'a theoretical reflection that would have acquired the quasi-legal status of a doctrine'²⁰ is a rhetorical device. For, indeed, artistic production has always been, to borrow a notion from Roland Barthes,²¹ the work of 'deciding groups', and not the object of collective consensus; and the reference to doctrines of the arts is more appropriate to modern art than to earlier periods. Furthermore, artistic production, particularly as it relates to architecture, is a process in which the patron always has the last word in defining the programme, if not also the design.

On the semiotic level, Oleg Grabar views the architecture of the Islamic world as heir to the arts of earlier empires in the region:

If one considers the mass of monuments that have remained from the first three centuries of Islamic history, the first conclusion is that, on the simplest levels of techniques and 'phonetic' forms, there is hardly anything new. Practically every decorative motif considered in isolation, every unit of planning, every detail of construction, and every kind of object has a direct prototype in the earliest artistic tradition of the Near East and the Mediterranean. Even when an occasional feature like the pool in the forecourt of Khirbat al-Mafjar has no known model, the existence of such an earlier model can be assumed, at least hypothetically.²²

Grabar suggests that the originality of the art of the Islamic world lies in its meaning. One of the dimensions of this originality is the method of composition and distribution. But the features on the basis of which meaning can be grasped, for example, inscriptions and concrete meanings associated with particular forms, such as the minaret and the *mihrab*-niche, are rare. 'A country estate, a ribat, and a caravanserai shared the same formal arrangement. ... In these cases, differences in purpose and use were not established by the monuments but by the activities taking place in them.'²³ According to Grabar, the central features of that architecture, namely ambiguity and flexibility, result from the 'primacy of human life and social needs',²⁴ and since there is virtually no literary evidence relating to the uses of buildings, our understanding of the features of the architecture of the Islamic world discussed by Grabar remains limited.

Robert Hillenbrand has discussed ambiguity in the following terms:

One final common denominator of much – though by no means all – ambitious public architecture in the Islamic world may be ventured: a penchant for illusionism and ambiguity. This finds the most varied expression in both form and decoration. ... Ambiguity and illusionism are taken even further in the field of decoration. ... The tilework within the dome of the masjid-i Shah creates light reflections within the dome that makes it seem as though the sun were shining through. The aim seems to be that the dome should be as insubstantial as possible, indeed as if it were transparent. Surfaces bedecked with tilework of floral design create the illusion of a building embowered in a garden. Above all, if a wall is richly embellished, attention is inevitably drawn in some measure to the decoration. By that same measure, the impact of the building as pure architecture is diminished. Architecture and decoration are therefore permanently at war. ... It would not be hard to 'establish' tempting connections between this way of looking at architecture and the rejection of prosaic reality

by Islamic mystics. In both cases metaphor clothes matter and renders it less material. Nevertheless, such a connection is not susceptible to proof and without further evidence it is merely dogmatism to state that it exists. The Muslim predilection for ornament might just as well be founded on a love of color or texture or design.²⁵

This passage reveals that the persistent questions of ambiguity and ambivalence remain unanswered. It also calls for a reflection on the distinction between architecture and decoration; Hillenbrand's distinction between architecture and decoration is, indeed, questionable. Is the notion of 'a pure architecture', as distinguished from decoration, faithful to the actual perception and practices of architecture throughout the history of Islamic societies? Should we not, as Umberto Eco suggests, look for the ways in which Islamic society 'solved for itself aesthetic problems as they presented themselves at the time to the sensibilities and the culture of its people', instead of reading these aesthetic choices through categories foreign to them? As I argue hereafter, the hypothesis that architecture, decoration and painting *concur* in the production of built space seems to be closer to the way Muslims perceived their own architecture and monuments than contemporary mainstream scholarship suggests, at least in the early centuries of Islam.

Architecture as Language

Although architectural aesthetics is clearly a historical construction, it is often viewed as a mere means of beautification. Not only is this view superficial, but it also overlooks the semiotic and historical nature of architecture. Theodor Adorno asserts that the pitfall of the bourgeoisie consists in presenting aesthetics as a transcendental phenomenon and as the neutral science of beauty. Discussing the historical nature of music he writes:

The assumption of an historical tendency in musical material contradicts the traditional conception of the material of music. This material is traditionally defined – in terms of

physics, or possibly in terms of psychology of sounds – as the sum of all sounds at the disposal of the composer. The actual compositional material, however, is as different from this sum as is language from its total supply of sounds. It is not simply a matter of the increase or decrease of this supply in the course of history. All its specific characteristics are indications of the historical process. The higher the degree of historical necessity present within these specific characteristics, the less directly legible they become as historical indications. ... All the tonal combinations employed in the past by no means stand indiscriminately at the disposal of the composer today. Even the more insensitive ear detects the shabbiness and exhaustion of the tones in the salon music of the nineteenth century. For the trained ear, such vague discomfort is transformed into a prohibitive canon.²⁶

Accordingly, Adorno declares the common recourse to classical aesthetic notions a retrogression. Such views reveal the naiveté of endeavours to create an authentic contemporary ‘Islamic’ architecture by simple reference to ‘great achievements of the past’. In overlooking and denying the historical and semiotic nature of architecture, this superficial view – which is the cornerstone of the fundamentalist Islamist discourse about new architecture and city planning – is both a retrogression and an illusion.

Decades ago, John Summerson argued that European classical architecture is articulated as a language.²⁷ This view is now generally accepted, and even the more abstract forms of modern architecture are recognized as a language unto themselves (Bruno Zevi).²⁸ This semiotic nature of architecture is the means by which it has become both autonomous and determined. The semiotic aspect of architecture is determined by the historical conditions in which the artist worked; even Michelangelo was confined by the artistic language of his epoch, the specific symbolic forms of Renaissance art. Art is autonomous to the extent that an artist could freely draw upon the classical rules of composition of the Renaissance, while simultaneously subverting them, thereby creating anti-classicist artworks. Such is the way

in which Mannerists are said to have deconstructed the artistic rules of the Renaissance.²⁹

The use of any language implies the conscious or involuntary aim of conveying meaning. This is also true of architectural language. Language necessarily involves a sender or addresser, and a receiver or addressee. In architecture the addressee is generally assumed to be the public of users and beholders. As for the addresser, a certain duplicity exists. Whereas in European architectural history, the architect occupies a major position, in the Islamic world the architectural planner³⁰ is rarely presented as the author or builder.

Rather, it is the patron who commissioned the work who is often presented in this authorial role. This is consistent with the common practice by Muslim rulers of claiming the authorship of monuments. The twofold form of authorship, with a forgotten designer and a design usurper, taints the perception of architectural meaning of both the public and the historian; as a result, historical investigation often fails to consider the designer/producer himself. This specific form of authorship (which was a general practice only challenged by the rise of the great Ottoman architects) has affected the use and, consequently, analysis of its semiotic/linguistic functions.

As a language, architecture must be investigated in all its linguistic aspects. The first aspect is the context in which architectural signification operates. We can identify this context as both the architectural culture shared by the addresser and the addressee, and the social context in which they live. In this sense, taking into account the context is an efficient methodological tool of investigation for art historians in general. As these contexts of production and reception change over time, they acquire different meanings for the people who view and interrelate with them. This perfectly illustrates the changing relationship between signifier and signified described by Barthes: 'Signifieds pass away, signifiers persist.' Furthermore, the interpretative work of art history consists partly in recreating past architectural contexts for the monuments it seeks to analyse, and these contexts are incrementally enriched, if not

radically changed with every new analytic attempt, and every disciplinary innovation in the field of history.

There are three major functions of language. The first and most important is the *cognitive* function (that is referential or denotative). In architecture, this is the same function that allows us to associate a door with in–out circulation. The second is the *conative* function. It is oriented towards the addressee. In linguistics, the imperative is its purest grammatical expression. In architecture, and art in general, it is best expressed by devices aiming at causing emotion in the addressee. The conative function (oriented toward the addressee) presupposes the necessary distinction between the plan of a building – which is often difficult to conceive of when looking at a building, and typically remains inaccessible to the eye of the uninitiated – and of what is intended, and which serves visually to impress the beholder.

Notably, this distinction lies at the heart of the question of the adequacy and limits of any system of representation in architecture, as demonstrated by Bruno Zevi.³¹ Now most architectural historians, especially those symbolically oriented, develop their arguments as if beholders were always aware of the characteristics of plans. However, the plans of palaces are, perhaps, the most illustrative of this misconception, for while palatial architecture is intended to impress as strongly as possible, plans of palaces must always remain secret. We shall therefore distinguish between architectural plans, and the conative qualities of architectural design. As design tools, plans have multiple functions: they can serve as simulations of projected buildings; ‘models’ for negotiation with and the seduction of clients, and a means for predicting cost, as well as organizing and controlling labour on the construction site.

The conative qualities of architectural design are the facets of design principles that have to do with programming the spatial experience of the beholder. For all principles of design are not necessarily perceived by the beholder (as is the case with the many principles for the organization of the layout, or with some mathematical proportions, such as the Modulor of Le Corbusier). The simplest of these principles, the scale, is certainly the most

effective in impressing the beholder.³² Classical art provides an excellent illustration of how artists took into account the perception of the beholder through the use of perspective, foreshortening, and optical adjustment.

The fact, says Vitruvius, is that the eye does not always give a true impression, but very often leads the mind to form a false judgment. In painted scenery, for example, columns may appear to jut out, mutules to project, and statues to be standing in the foreground, although the picture is of course perfectly flat. Similarly with ships, the oars when under the water are straight, to the eye they appear to be broken. ...

Since, therefore, the reality may have a false appearance, and since things are sometimes represented by the eyes as other than they are, I think it certain that diminutions or additions should be made to suit the nature or needs of the site, but in such fashion that the buildings lose nothing thereby.³³

Optical adjustments were made on the width and form of columns and on sculptural proportions. Perhaps it would not be too adventurous to venture the hypothesis that similar optical adjustments were applied in the first storey of the Umayyad minaret of the mosque at Qayrawān, Tunisia CE 727–8, in which the height of the windows increases slightly from one window to the next one above it, possibly with the aim of appearing as if they were the same size. All this may indicate that an awareness of perspective foreshortening was passed down to the Umayyad architects through the Byzantines.³⁴ Another illustration of the conative function in the early architecture of the Islamic world is the merely decorative function of the defensive towers of the Umayyad country palaces, such as in Khirbat al-Mafjar and Mshatta (plate 6).

The third function of language is *phatic*. It relates to the addresser, and aims at expressing emotion. This function is affected by the twofold authorship, and is the least accessible to

analyse. This limitation, paired with the absence of relevant documentation of the process of design, represents a significant obstacle to understanding fully the creative processes central to architectural planning.

However, I will suggest that an analysis of the two other functions of language, the cognitive and the conative – as they have been documented in the literary sources and preserved in the architectural works themselves – might allow us to understand what the phatic dimension of architectural representation might have been. The cognitive function can be broken into three constituent parts – metalinguistic, referential and poetic. The metalinguistic dimension of the cognitive function of art and language is rhetorical *par excellence*, and is best illustrated in the use of classical architectural elements, or *clichés* in postmodern architecture.³⁵ The referential form can be illustrated by the use of the cupola in the Islamic world, which to serve as a symbolic representation of the heavens must refer precisely to a certain image of the heavens. The most prominent function in art is the poetic. Beyond its symbolic element (for instance, representing divine perfection), this function aims to support the conative function of architecture.

The poetic function of the architecture of the Islamic world has always been clearly perceived by historians, who have often spoken of its relation to a perfect use of proportions. The conative function plays a fundamental role in the perception of architectural works. It was recognized as a very important form in the architecture of the Islamic world, as witnessed in the accounts of early Arab historians, who attributed the impact of Christian monuments to their effect on the mind and emotions of their beholders.

Muqaddasi, for instance, explained the aim of early architecture as one of producing works that could compete with the conative function, the seduction and fascinating powers of Christian monuments. Yet, despite art historians' awareness of the importance of the conative and poetic functions in architecture, previous work has misunderstood the significance and role of the poetic function.

ARCHITECTURE AND POETICS

It should be known that both poetry and prose work with words, and not with ideas. The ideas are secondary to the (words). The (words) are basic.

(Ibn Khaldun)³⁶

It is therefore necessary that in a poem, meaning does not overpower its form and destroy it without return; on the contrary, it is the return, the preserved form, or more precisely its reproduction as a unique and necessary expression of the state, or the thought that it creates in the reader that is the strength of the poetic power.

(Paul Valéry)³⁷

In his *Formation of Islamic Art*, Oleg Grabar states that one of the primary features of the art of the Islamic world is its ambivalence and ambiguity in the use of the signifier.³⁸ Grabar suggests that early architectural elements seem to have no specific signification in their architectural context. What imbues an architectural element with meaning is its human use. Grabar accordingly posits the primacy of human/social life in unravelling the meaning of art in Islamic societies. Yet, would it not be more appropriate to read this semiotic ambiguity as a poetic indetermination of sense in R. Jakobson's terms? I will argue that emphasizing the poetic side of architectural language is more apt than Grabar's conception, if we are to understand the geometricism, ornamentalism, and flexibility of that art, as well as its inclination toward what Bataille has called '*la part maudite*' – the prodigal and sensuous production of form through the annihilation of sense.³⁹

The definition of the poetic function is indeed of primary importance here. To the question 'What is the empirical linguistic criterion of poetic function?' Jakobson answers:

We must recall the two basic modes of arrangement used in verbal behaviour, *selection* and *combination*. If 'child' is the topic of the message, the speaker selects one among the

extant, more or less similar, nouns like child, kid, youngster, tot, all of them equivalent in a certain respect, and then, to comment on this topic, he may select one of the semantically cognate verbs – sleeps, dozes, nods, naps. Both chosen words combine in the speech chain. The selection is produced on the base of equivalence, similarity and dissimilarity, synonymy and antonymy, while the combination, the build up of the sequence, is based on contiguity. *The poetic function projects the principle of equivalence from the axis of selection into the axis of combination.* Equivalence is promoted to the constitutive device of the sequence.⁴⁰

Jakobson later asserts that poetic metre, or verse design, ‘underlies the structure’ of any single verse instance. Is it not remarkable that architectural concepts are thus used in the analysis of poetry? Does not architectural composition use the very same mechanism of *projecting the principle of equivalence, that is the axis of selection, onto the axis of combination? Are the theory of proportions and its mathematics not the concrete proof of this mechanism?* And is the architectural theory of proportion not related, in one way or another, to the same musical model of metric poetry, as seen in the example of Renaissance architecture?⁴¹

Architectural aesthetics cannot be reduced to its poetic function; as with verbal art, the poetic function is not the sole function, merely its dominant form. In architectural works, all functions coexist. Jakobson illustrates this theory by referring to Valéry’s view of poetry as the ‘hesitation between the sound and the sense’.⁴² In Valéry’s view, ‘the supremacy of the poetic function over the referential function does not obliterate the reference but makes it ambiguous.’ And to clarify his point further, he cites Empson, who says, ‘The machinations of ambiguity are among the very roots of poetry.’⁴³

Similarly, in architecture the supremacy of poetic function does not eliminate the significance of other functions, such as usage. Its machinations merely render these functions ambiguous. This concept is clearly foreign to architectural functionalism, for which space is fundamentally heterotopic, and ambiguity suspect.

However, in most architectural traditions, space is homotopic, as Rudolph Wittkower evidenced in classical architecture, and, as Robert Venturi noted, ambiguity is productive of meanings and, hence, consciously incorporated into design.⁴⁴ To assert that in the architecture of the Islamic world, social content alone is generative of meaning is to obliterate its most characteristic quality. Therefore, only a poetic approach – one that reflects on ambiguity and the poetic dimension of architectural creation and form – could enable us to apprehend more fully the architecture of the Islamic world, and its ambiguous use of the signifier.

Architecture and Politics

... there is nothing beautiful in which the immanent moment of injustice can be eliminated.

(Theodor Adorno)⁴⁵

The political function of architecture in early Islamic history has always been well perceived and articulated by art historians. It was first articulated in the presentation of its dynastic aspect, as in Georges Marçais's work, in which he relates styles to dynasties. Later, a more subtle approach based on iconography and textual evidence led to a finer political analysis of that architecture.

Art historians analysed monuments as political statements by monarchs serving to trumpet the victory and superiority of the new faith (Grabar), and/or the victory of a dynasty (Rabbat). More recently, analysts have drawn a parallel between the stylistic elements of the architecture of the Islamic world, and the political system of empire. The successful synthesis and combination of different techniques, material and styles in the Umayyad period were linked to labour conscription, and to the political organization of the empire, which allowed caliphs to divert huge amounts of money to realize their building programmes (Hillenbrand).⁴⁶

The understanding of the relation of politics to architecture has thus become progressively more nuanced. Yet, analyses always reduce architecture to a mere reflection of political power, a pyramidal system in which the head dominates and directs the

lower parts. This conception of power is, by its very nature, static and can explain neither political change nor how and why power maintains itself as a structure.⁴⁷ A more accurate conception of power as a dynamic system with different agents interacting both to maintain and to change it, is not only more apt to explain the evolution and revolutions of power, but also to take into account the social criticism, the injustice it implies, and the struggles that surround royal building activities. Indeed, a relatively significant body of literature, which includes *hijā'* (a critical genre of poetry), and critical reports, in particular about Umayyad architecture – exists; but in that scholarship such material is generally dismissed as negative propaganda.

However, this literature should instead be considered as the expression of a more complex social reception of royal architectural works. Beyond the discursive polarization of 'proclamation versus propaganda', this literature is an entryway into understanding the social dynamics that make possible the flourishing of architectural works at certain times, and that preclude them at others. Perhaps, we should consider architecture as a means for exercising power – that is, as a complex strategy of public expenditures, labour policy and spatial semiology – rather than viewing it as a univocal expression of power.⁴⁸ As the French Renaissance architect Philibert de l'Orme said in the introduction to his treatise:

For, I beg of you, what greater good can one find, and what greater charity and piety can one exercise, than to provide sustenance for the myriad of poor people, who would otherwise beg for their bread, by way of building? What profit might be greater in a kingdom, a province or a town, than to employ, to provide work and occupation for a multitude of men, women, and youngsters, who would otherwise be ne'er-do-wells and possibly vagabonds and thieves, to the great detriment, I will not just say of cities and villages, but also of an entire country, as Aristotle develops in his beautiful argument in *Politics*, consistent with that with which his master Plato took issue.⁴⁹

Architecture is the best way to employ large masses of workers, activate the economy, create prosperity, preserve social peace by fighting wandering and inactivity, and on top of that, leave great monuments to posterity.⁵⁰ I suggest that it is only in grasping this complex nature of architecture that we can understand Adorno's post-classical question: what is art, and what is the relation between aesthetics, power and violence, their fundamental entanglement; what is the transformative force of art, as the possibility of imagining and creating the world anew.

Architecture and Meaning

The absence of literary works devoted to art and architecture in the early centuries of Islam has represented a challenge to art historians, who have tried to recover the aesthetic views that shaped the art and architecture of that period. Papadopoulou, among others, has suggested that two philosophical systems may have helped shape the art and architectural aesthetics.⁵¹ Certain scholars have accordingly pointed to the influence of both Greek philosophy (and in particular, atomism), and the theology of *attawhīd*. Louis Massignon asserts that the art of Islamic societies is based on a theory of the universe according to which forms and figures do not exist as such, because only God has permanency. Similarly, he says that for Muslims, nature does not exist for it is simply a series of atoms and ephemeral accidents. Art in Islamic societies is thus a negation of the permanency of form and figures.

Grabar has shown how Louis Massignon's thesis – that these changes in the representation of physical reality in 'medieval Islamic art' reflect a theological belief about the impermanency of the visible world – has been 'used without consciousness of historical evolution and changes over time'.⁵² Indeed, the speculative nature of his thesis begs further examination.⁵³ In fact, Massignon, himself, appears not to restrict his thesis to the art of any particular period. He illustrates his essay with al-Mutannabbi's poetry (tenth century), Moroccan Andalusian music of later centuries, and even with more recent descriptions of the gardens of Aguedal, Marrakech, conceived by the Tharaud brothers. It seems that his essay was intended to highlight the 'trans-historical

characteristic' of art in Islamic societies. Furthermore, Massignon limits the theological sources upon which he draws to accounts of the Prophet reported by early traditionalists and fails to provide further textual evidence in support of his argument, which therefore remains purely hypothetical.⁵⁴

Indeed, it is important to ask how one explains the trajectory of the development of the art of the Islamic world from its early highly diversified use of forms with the inclusion of figure painting to its more abstract expressions of later centuries (see plates 6 and 8–11).

Massignon begins his paper by arguing against the common idea that Islamic societies lack any form of visual art. He develops his argument by discussing the question of representation. After noting that the Qur'an does not formally condemn figurative art, Massignon discusses the role of the sayings of the prophet, and quotes a famous saying: 'artists and makers of figures will be punished on the Day of Judgment by being asked to perform the impossible task of giving life to the figures they created.'⁵⁵ Thus, consistent with all other discussions of the early Islamic community's attitude toward the arts, Massignon frames his essay within the context of the ban on the representation of living beings. As mentioned above, this relied on the classical conception of art as a representation of the human body. This purview has limited the supposed purpose of art in the Islamic world to uncovering the 'invented substitutes to figurative representation' and prevented a more meaningful exploration of the specific Islamic attitude toward art and its many disciplines from taking place. I will suggest that only knowledge of the evolution of perceptions of art and architecture in Islamic societies can provide us with an appropriate basis for the study of its meaning and thus enable us to develop theoretical views based on the available descriptive history.

The Entanglement of the Arts

It is customary among art historians to promote some forms of art to the rank of major arts and to downgrade others to the realm of minor arts. It seems that most historians consider architecture as the major form of art in the Islamic world. Against this conception,

Papadopoulo argued that the figure of the architect, as we now know it, did not exist in the historical periods under consideration. Furthermore, 'It is certain', he says, 'that Muslim architecture as such was scarcely considered an art.'⁵⁶ He accordingly explains that all those who worked in building were considered masons at the time, that is 'manual workers', and as such were not admitted to the circles of princes. By contrast, painters were viewed as true 'artists' and thus regularly welcomed at the royal courts. Moreover, kings and princes did not scorn painting and calligraphy. Given the social prestige of painting in the history of Islamic societies, Papadopoulo concludes that painting, and more specifically miniature painting, should be considered the only major visual art of Islam.⁵⁷ The problem presented here is not merely rhetorical. Rather, underlying the question of rank and classification is the more important issue of faithfulness to the changing perception of art by Islamic societies themselves.

In the light of the historical evidence, Papadopoulo's argument can hardly be supported in the context of the early centuries of Islam. For, until what Ettinghausen calls 'the flowering of the art of the book', CE *circa* 1200, miniature painting does not appear to have been a particularly sought after medium.⁵⁸ Moreover, in contrast to Papadopoulo's reductive argument, there is a tradition of myths about architects, such as Sinimmār and King Solomon, which confers real social and intellectual stature and prestige upon the authors of buildings. According to this tradition, architecture was indeed perceived as an almost magical activity. It is not accidental that many buildings were said to be the creation of *djinns*, or spirits. If in the early Islamic period, architectural planners were never mentioned, this is mainly because doing so would have contradicted the common claim by kings and patrons that they were the authors of their buildings. Is it not significant that an 'Abbasid caliph such as al-Māmūn (ruled CE 813–17) erased 'Abd al-Malik, the name of the Umayyad builder, from the mosaics in the Dome of the Rock and replaced it with his own, claiming to be the builder of the monument?⁵⁹

Thus, historical evidence contradicts Papadopoulo's argument. But does this mean that the problem of classifying major and

minor forms of art remains unsolved? Or does it instead mean that each period elected a medium for that purpose? In reality, 'there are no unsolvable problems, there are only false problems', as the historian of science Gaston Bachelard once said. And, of course, false problems do not have answers. 'A problem formulated correctly is a problem that is already solved.' In the case of early epochs of Islamic history, my argument is that it is inappropriate to separate architecture, painting, and mosaics.

Viollet-le-Duc has shown that such modern subdivision of the arts cannot be applied to previous periods, such as Medieval Europe, to which it was foreign.⁶⁰ In a similar sense, we must recognize that in the early centuries of Islam painting and mosaics were an integral part of architecture. Inasmuch as they were conceived as corollary to architectural works and inconceivable independently, their very existence was conceived as a pure adjunct to architecture. Art historians who understood decoration to be fundamental to any meaningful analysis of buildings sensed this aesthetic concurrence.⁶¹ Along these lines, mural painting has been aptly analysed within its architectural context.⁶² Yet, for many art historians painting remains unambiguously classed as an autonomous art. There is evidence, however, that in the first centuries of Islam, painting was above all a prominent component of architecture, despite the fact that figures are found on textiles and, to a lesser extent, in books. It is only with the flowering of the art of the book that painting, conceived as illustration, became an autonomous form of art.

I will suggest that an approach to the arts of Islamic societies that considers it in its complexity, with architecture, decoration and painting concurring in the production of built space, is closer to the way Muslims perceived their own architecture and monuments in the early centuries of Islam (up to the tenth century CE). In considering the whole of built space, including painting and decoration, it may be possible to learn more about the evolution and views of architecture if one considers iconography as well. It may also help to counterbalance the troublesome lack of written sources directly related to architecture, which inevitably comes to the fore in this debate.

My argument is that there is a further spectrum of documents through which the perception of art in the early Islamic period can be investigated. In the absence of specialized treatises devoted to art and architecture in the early period, evidence must be sought in the larger corpus of early Arab literature, as well as in the monuments themselves. Indeed, scattered references to explicit attitudes towards the arts exist in historical, poetical and other sources. My investigation makes extensive use of these literary and theoretical works. It gives central attention to the work of al-Jāhīz, as well as to other less famous works, such as *Kitāb al-‘ashr maqālāt ‘alā al-‘ayn*, *The Book of Ten Treatises on the Eye*,⁶³ one of the first Arabic medical treatises ascribed to Ḥunain ibn Ishāq (CE 809–77).

The Limits of Literary Evidence

The prevalent recourse to ‘Abbasid sources in the study of the Umayyad caliphate is certainly problematic. Many authors have raised the issue and to discuss it once more could appear unnecessary were it not that the present work takes a slightly different approach. The issue of studying a historical period by referring to the written sources of a later period raises the problem of the bias such sources may contain towards the reality they are supposed to describe. In the case of the ‘Abbasid authors, who are known more or less as enemies of the Umayyads, that bias may consist of any one of four mechanisms that threaten historical recovery.

The first mechanism is *invention*. This is probably the simplest problem to rectify. The traditional solution, employed consistently by historians and art historians such as Creswell, is to check the later against earlier sources, and give more credit to the earliest ones. The second mechanism is *translation*, meaning that authors infuse their own language into the reality they depict. To recover the original reality, the historian’s task would be to undo this translation. But the historian may simply provide a new translation without ever reaching the original form. The third mechanism is *distortion*. Even though translation may be viewed as a form of distortion, the distortion of translation is generally

involuntary. There is also the possibility of deliberate distortion, a voluntary act aimed at presenting an event in a certain way to make it convey a particular meaning. (This mechanism is also detectable by means similar to those used to uncover invented 'historical events'.) The fourth element of bias is *selection*. This is a more diffused and common practice, since selection always operates as a basic characteristic of human perception. All historical accounts, including contemporary ones, are subjected to the logic of selecting the elements that are meaningful to those who are making the report, to the exclusion of others. Selection is therefore a more difficult obstacle in the work of historians. The sole solution to avoid the negative effects of this bias is to use as many and as diverse a range of sources as possible.

Nonetheless, there remains an insurmountable bias that lies in the very nature of textual sources. This fact pertains to all textual sources of the past. In other words, these sources specifically reflect the worldview of the literate class and hardly give any idea of the conceptions of other social groups. Despite all methodological precautions that may be aimed at preventing and partly overcoming these difficulties, this remains an inevitable bias and one that determines the fundamental hermeneutical position of the historian. It is for this reason that Jacques Le Goff argues that 'history is a myth'.⁶⁴ According to Le Goff, any attempt to recover the past is hypothetical, partial (because of the necessary limitation of the sources) and oriented (because of the epistemological frames of both the sources and of the historian) in a particular direction.

In Islamic studies, the sayings of the Prophet Muhammad represent an excellent example of these phenomena, with which Muslims were confronted as soon as critics began assembling the collections of ḥadīth. In the development of Islamic law, the authority of the prophet, expressed through his words and his behaviour, was invoked as the model to follow in all circumstances not otherwise addressed in the Qur'an. Each group invoked the prophet's authority to support the ideas it promoted. Therefore, it is not surprising that forgery and distortion were employed: 'It took no extraordinary discernment on the part of Muslim critics to suspect the authenticity of much of this material: some reports

were betrayed by anachronisms or dubious features, others were contradictory.⁶⁵ Goldziher cites a ḥadīth according to which a woman reports that the prophet once saw her in the street; and when he asked her from whence she was coming, she replied, 'from the baths'. The forgery here was evident inasmuch as there were no public baths at the time of the prophet. Muslim traditionalists – the commentators and collectors of the teachings of the prophet – developed a sharp system of critique and verification of the ḥadīths, which allowed them to identify a few thousand, out of tens of thousands of sayings that were forged. To be validated, each saying was submitted to a set of examinations. The most important of these examinations required that a saying have a solid chain of transmission derived from a well-known companion of the prophet who could testify to its veracity; that it in no way contradicted other well-established teachings; and that it conformed to the frame of thought of the Qur'an.⁶⁶

It is also known that the forgery of pious sayings attributed to the prophet was indulgently practised and widely accepted, as long as these inventions were not considered unethical. Therefore, it is likely that, to support their own legal views and political positions, a majority of groups and a great many religious authorities invented useful apocryphal sayings. Consequently, we can expect that such an attitude may not have been limited to this field, but instead was common to all literary sources of the time. Indeed, it is of public knowledge that the same debate exists about poetry and literary works. Many poems, for instance, are thought to have been wrongly attributed to Majnūn Layla, and some critics go so far even as to doubt the very existence of that poet. Convenient forgery, literary theft, or opportunistic attributions of poems and literary works were common, and not considered totally unethical. Thus to ridicule his ill-intentioned and jealous critics al-Jāḥiẓ attributed some of his works to other authors, and used the praise of these works by the former to show that their criticism of his works had nothing to do with their qualities but was based merely on their jealousy of him.⁶⁷ It is thus with cautionary awareness of the epistemological limits and relative truth of any available literary evidence that this research must be conducted.

THE AIMS OF THIS BOOK

By asking different questions, drawing new parallels, and using available literary sources not yet exploited, my contribution to the debates about the architecture of the Islamic world seeks to show that an interpretation of the central features of its early production need not make recourse to either purely sociological or, conversely, mystical views. This book presents the argument that Umayyad and 'Abbasid architectures rely on a *modus operandi* in which the poetic function is dominant. Denotative, symbolic and other functions coexist in architectural works but are rendered ambiguous by the primacy of the poetic function. In contrast to the prevalent view that considers ambiguity an obstacle to understanding the artistic meaning of the architecture of the Islamic world, my work stresses the foundational role of ambiguity in the poetics of architecture in general, and of that architecture in particular. Hence, my argument develops parallels between Arabic poetics and theories of language from the eighth to the early tenth century, and the architecture of the same period. In contrast to mainstream views in the field, I seek to demonstrate that early Islamic authors developed a theory of visual perception through different theoretical and theological works.

My discussion will concentrate on five major issues, each leading down a specific path and involving a different set of questions related to the history of art and architecture of the early Islamic centuries. For theoretical reasons, I pursue each of these paths in a separate chapter. The first four chapters of this book unfold each on their own, as if they were independent parts; yet, as he or she reads along, the reader realizes that they develop and describe the same theme from different angles before converging in the last chapter. It is in Chapter 6 that all the strands developed in the previous chapters are woven together to articulate the complex problematic of artistic production in the formative period of the architecture of the Islamic world.

As I argue in my conclusion it is 'common sense' to expect a book to unfold as a well-structured narrative, with woven chapters leading from a clearly stated set of queries, hypothesis and methodological tools to their *mise en oeuvre* in the successive parts or

chapters, and an artfully orchestrated presentation of the expected results. But, as I show in the conclusion of this book, this kind of staging is misleading at both the level of the lived experience of research and the structure and genesis of the subject matter itself. Furthermore, it often tends to create the illusion of possessing a theoretical framework that allows a totalizing grasp of the subject matter, and therefore excludes queries that do not seem to fit in this intellectual framework. This totalizing pitfall is to be avoided if we are to take on the challenge of advancing the study of the art and architecture of Islamic societies to the theoretical level of art history, and to do so requires an open structured approach that draws different and converging paths to the analysis. One needs to keep in mind that the paths proposed here are only some of the possible ones. I am convinced that an open theoretical approach that does not lead to the illusion of a totalizing and complete intellectual grasp of the subject matter is necessary to keep alive the sense of curiosity, the awareness that more research and investigation are needed, and the much needed corollary of an open mind.

Chapter 2: Architecture and Meaning in the Theory of al-Jāhiz

Following the introduction, the book examines al-Jāhiz's theory of *al-bayān* as developed in *Kitāb al-Ḥayawān* (The Book of Animals) and *Al-Bayān wa al-Tabyīn* (roughly translatable as 'Expression and Persuasion'), in which architecture is presented as a core medium similar to speech and poetry. This idea supports the notion of the primordial importance of architecture as a component of *al-bayān* in both Muslim aesthetics and, more fundamentally, in the existence of social life itself. In this chapter I give a systematic account of al-Jāhiz's theory of *al-bayān* as it is presented in his work. I then seek to point to the connections between architecture and decoration on the one hand, and language and poetry on the other, as suggested by al-Jāhiz. I finally show how the mechanisms of *al-bayān* operate in the perception of architecture, and how architecture produces meaning within this epistemic configuration.

Chapter 3: Architecture and Poetics

In this chapter, building upon the conclusions of the previous one,

and on the similarity of the functions of architecture and singing, I develop parallels between song, poetry and architecture as manifestations of similar processes of artistic creation. I argue that the design principles of the early architecture of the Islamic world (geometricism and ambiguity) are structurally connected to the basic principles of the Arabic theory of language as developed by al-Khalil in *Kitāb al-'Ain*, and of poetics as developed by the same author in *Kitāb al-'Arūd*, the latter book being lost. Inspired by Erwin Panofsky, I argue that comparable styles of thinking and doing (or *modus operandi*) are at work in the architecture and Arabic poetics of the early centuries of Islam. The chapter thus first presents the Arabic view of poetics during the eighth and ninth centuries, and pinpoints the formal rules it inaugurated. It then endeavours to show how the principles of design of architecture were based upon similar rules. I thus show how the primacy of form over meaning, demonstrated in the particular trend in Arabic poetics best represented by al-Khalil, finds echoes in the ambiguity of architectural form and decoration. Similarly, I compare the organization of the *qaṣīda*, the Arabic ode, to the spatial programming of the beholder's experience in the architecture of its time.⁶⁸

Chapter 4: Architecture and Myth

In the fourth chapter I analyse the Arabic myth of grandiose architecture (as embodied in the work of al-Hamadhāni and others) to demonstrate the foundational character of ambiguity in the Islamic conception of architecture and art. My hypothesis is that the question of Muslim attitudes toward pre-Islamic architecture may be better answered through the study of literary sources concerning grandiose Arabian architecture than by relying exclusively on the condemnation of *al-jāhiliyya* (or pre-Islamic Arab culture) by the pious, as has often been the case. The legends must be considered in their different versions, for they evolved over time, and their different versions enable us to understand better the evolution of the representation of architecture in that society. In this mythology, which is central not only to Arab but to all Islamic cultural forms, architecture is paradoxically considered both a divine gift and an ill that misleads human beings (and civilizations)

into an ultimately confusing state – one in which the awareness of death and the other world (central to Islamic theology) is thrown into oblivion. I thus argue that ambiguity is found not solely in the actual artistic forms, but also in the discourse, theology, mythology and language of collective memory.

Chapter 5: Al-Jāhīz in the Mosque at Damascus: Social Critique and Debate in the History of Umayyad Architecture

The formation of the art of the Islamic world has been compared with the formation of European Renaissance art and architecture following the rediscovery of ancient Roman and Greek remains. Yet, a serious question should be raised in both cases about the nature of the continuity invoked.

As Erwin Panofsky has pointed out, the ‘discovery’ and use of ancient ruins by artists of the Renaissance were indeed problematic.⁶⁹ The ruins had been there for centuries, but only with the Renaissance did they suddenly become meaningful. Their rediscovery had to do with a cultural change of attitude at the end of the Middle Ages. In a similar sense, we should consider the possibility that a reflexive attitude towards the arts might have developed in the early Islamic period.⁷⁰

In this chapter I explore the implications of that early debate on architecture. Taking the lead from an account by al-Jāhīz, I attempt to follow the line of interpretation it suggests in terms of a ‘double’ attitude towards architectural decoration. I discuss its implications for the history of Umayyad architecture, with particular emphasis on the social dimension of architecture, considered as an expression of the complex social reception of royal architectural works, and as a tool for understanding the social dynamics that made possible the flourishing of architectural works at certain times and their virtual preclusion at other times. In other words, I reflect on architecture as a complex strategy of public expenditures, labour policy, and spatial semiotics, rather than viewing it as a univocal expression of power.

Chapter 6: Architecture and Desire

Here I discuss the dialectic of desires that surrounds the architec-

ture of early Islam (the desires of the designer, the patron and the viewers) and its consequent effects of creation, consumption, delight, ruins and death. I then try to demonstrate how, despite the faith in the inescapable fate of architectural works, at least according to Islamic scholarship and tradition, that dialectic of desires leads societies constantly to create new works and initiate new cycles of ruins and destruction. A story about Ziyād and his masons reported by Tabari sets the stage for this discussion, as this story illustrates the relationship between masons (or architectural planners) and patrons in terms of their power dynamics. It also introduces two crucial features that are at stake in architectural planning – desire and its expression. Reflecting on the relationship of architects and clients raises the fundamental theoretical question of the dialectic of desires in architectural production: can an architectural work be read as the shared object of people’s desires? How is it possible for one person, the architect, to express the desire of another? And how does the architect’s desire intervene in that process?

To answer these questions in the context of the production and reception of the architecture of the early Islamic world, I try (1) to define the creative agents (the designers or architects), (2) to describe how these agents performed their creative works, and the principles upon which they constructed them, and finally, (3) to discuss how they communicated with their patrons and the actual workers on the building sites.

On the basis of architectural evidence and literary sources of the time, such as al-Khalil’s definition *al-takḥṭīṭ ka al-tasṭīr*, I show that the notion of *al-tasṭīr*, the key of any decorative pattern and composition, implies a hidden order of architecture that is foreign to any mystical view. On the contrary, this hidden order of architecture can be related to al-Jāḥiẓ’s theory of *al-bayān*.

An account by al-Tha‘ālibi about the relationship between Caliph al-Mutawakkil and the poet Ibn al-Jahm, and a poem by the latter about a palace of the caliph, introduce a series of new questions about the perception and the function of architecture. The account introduces the notion of desire for architecture, and compares it with the desire for women and wine. The analysis of

the poem by Ibn al-Jahm reveals the existence of a sophisticated view of architecture based on the notions of desire and the gaze. Moreover, other literary sources (such as Tabari and Masūdi) indicate that architecture is but a piece of a complex system of representation used by al-Mutawakkil as a semiotic system for control and social segregation.

The central role of the gaze in this system indicates the existence of a complex view in which visibility and control are just the visible tip of the iceberg. I suggest that a close examination of the works of intellectuals, such as al-Shāfiī and Ḥunain ibn Isḥāq, reveals that Arab authors were more interested in the phenomenon of vision than was believed by most scholars of Islamic culture, and that their view was based on an elaborate understanding of the relationship of desire and the gaze.

2

Architecture and Meaning in the Theory of al-Jāhiz

Whenever the Prophet walked on a street and passed a tree
or a rock – it is said – the tree or the rock greeted him.

(Tabari)¹

As I discussed in the Introduction, the absence of textual evidence of a doctrine of the arts in the early centuries of Islam remains a serious obstacle to understanding the development of the art and architecture of that period, and interpreting its meaning. To circumvent this problem I suggest that one can garner crucial clues about this early development by exploring the semiotic worldview of al-Jāhiz. Yet, given that his theory of the sign has never been studied as such, I shall first introduce the reader to his notion of *al-bayān*, before proceeding to explore important connections between architecture, decoration and language as articulated in his work.

But before moving further in exploring al-Jāhiz, I should raise a general epistemological question about the use of literary and philosophic works in the discipline. Islamic philosophers of the late-tenth to mid-thirteenth centuries have often been used to study the question of aesthetics in Islam without much historical discernment. Indeed, whereas art historians of European art have rightly invoked Western philosophy and aesthetics in terms of their historicity and related epistemological discontinuity, most works on Islamic aesthetics make recourse to Islamic philosophy based on an unquestioned assumption of epistemic continuity across the centuries – an assumption that I question in this work.

In this respect I emphasize that there is a radical epistemic break between al-Jāḥiẓ's worldview (ninth century) and that of authors of the late tenth to mid-thirteenth centuries. To illustrate this point it is enough to notice that whereas most of the later authors seem to consider the notion of beauty central to aesthetics understood as divine manifestation,² in the view of al-Jāḥiẓ every single creature, be it beautiful, ugly or monstrous, even a fly or a rock, manifests the greatness of God.

You should know, says al-Jāḥiẓ, that a mountain is not more telling about God than a pebble, nor is the astral system that contains our world more telling than the human body. The smallest and the lightest are equivalent to the biggest and the greatest. For things do not differ in their truths (*ḥaqā'iqihā*), but it is those who think about them who establish differences, and those who neglect the multiplicity of angles of vision, who ignore sites of differences, and the components of boundaries.³

In this view aesthetics cannot exist independent of *al-bayān*. That is why it is necessary to expose the complex view of al-Jāḥiẓ in detail.

One might wonder how books by al-Jāḥiẓ such as *Kitāb al-Ḥayawān*, a book about animals, may be relevant to the study of aesthetics and art history, and further, crucial to conceiving the function and formation of architecture in the Umayyad and 'Abbasid empires. Yet, this extraordinary writer's approach and insight are far more complex than the title of his book might suggest. The uniqueness of the book lies in the way al-Jāḥiẓ studies animals as animals-in-the-cosmos – as inseparably tied to the universe rather than as biologically independent species. In conformity with the religious cosmology of the time, animals are presented as a part of the world that is itself understood as a manifestation of the wisdom of God. All objects and beings are submitted to a system that manifests *al-bayān*, a term that means at once signification, communication, information, manifestation and expression.⁴

In reflecting on the extent to which his thought was representative of prevalent views and opinions, it is important to recall that al-Jāhīz was one of the most famous prose writers of his time. Born in Basra in about 160 AH/CE 776, he was admitted very early to Mu'tazilī circles, which were animated by the primary intellectual debates of the time, such as the question of harmonizing faith and reason, and that of the caliphate. It is assumed that although he never held an official position, his works won him great renown, and that he received large sums of money for the dedications of his books. It is also rumoured that the Caliph al-Mutawakkil wished to entrust al-Jāhīz with the education of his children, but fired him after three days on account of his ugliness.

Al-Jāhīz wrote extensively on diverse issues ranging from *al-adab*, entertaining literature, to theology and politics. Charles Pellat writes that in politics as in theology al-Jāhīz was a Mu'tazilī, and that 'his doctrine appears to offer hardly any original feature'.⁵ The Mu'tazilī school was one of the most influential Islamic schools of philosophy, and its two major principles were the unity of God and divine justice; along with freedom of will. Their philosophic positions shaped all intellectual, political and theological debates in the Islamic world from the end of the eighth to the tenth century. Due to the great influence of the Mu'tazilī school, and al-Jāhīz's faithfulness to its theories, it is reasonable to assume that al-Jāhīz's work reflected a common view of the issues at hand. In particular, it seems plausible to assume that his theories of *al-bayān* reflect not simply a personal view, but one with widespread adherence before and after his time.

In his work *Kitāb al-Ḥayawān* (The Book of Animals), al-Jāhīz asserts that *al-bayān*, which I provisionally translate as signification, is a basic component of life in general and of human life in particular. *Al-bayān* is what makes possible the most fundamental dimensions of human life, such as communication and the organization of society. It also plays a central role in the construction of memory and history. By ensuring the transmission of knowledge and wisdom, and the remembrance of the past – key elements in the strengthening and refinement of civilizations – *al-bayān* is the manifestation of the primordial component of society.⁶ This term,

which resists any easy translation, is nonetheless crucial to understanding what the notion of architecture might have been during the early stages of the development of Islamic societies. I hope that as I proceed, the more subtle and multifarious meanings will become apparent. In this chapter, then, I seek to explore *al-bayān* as discussed by al-Jāhiz as a means for understanding what the perceived function and meaning of architecture might have been during its early conceptualizations.

The construction of memory and history in which *al-bayān* partakes relies on the commemorative marking of time and the construction of memorials. According to al-Jāhiz, each civilization has its own memory devices. He thus explains:

In their *al-jāhiliyya*, in order to immortalize something, the Arabs wisely had recourse to harmonious poetry, and to prose. These were their archives [*wa kāna dālika huwa dīwānuhā ...*]. The Persians made their monuments from buildings, thus Ardashīr built Istakhr the White, [as well as] Ctesiphon, and many towns, fortresses, and bridges. He said: later the Arabs wanted to share the Persian custom of building, while keeping poetry for themselves. Thus, they built Ghumdān, the *ka'ba* at Najrān, the palace at Mārid. ... It is for this reason that the Persians did not authorize noble architecture, like noble names, but for noble families. Hence mausoleums, baths, green cupolas, balconies, gateways, and so forth were reserved for the nobility.⁷

Architecture and poetry thus play a similar role in the construction of history and memory. And they are not simply comparable in terms of their function of commemoration and monumentalization, but are also consonant in terms of the effects of their communicative powers. Indeed, recounting how 'Umar Ibn 'Abd al-'Aziz covered the decorated walls of the Damascus mosque with draperies, and 'planned to unadorn'⁸ them and to boil the chandeliers to reduce their glitter, al-Jāhiz comments that, 'marvellous beauty and charming refinements lead hearts astray and disturb meditation, and no mind can rest

and gather itself when there is a thing that scatters [its attention] and opposes its unity.⁹

In other words, decoration has a divisive effect both on the unity of the soul and its concentration on God's ways. And, as I shall discuss later in the chapter, poetry and song were also understood to possess such powers of sway and discord. Architecture, like poetry and song, were thus condemned by zealots. Yet, while there is a well-documented debate about the lawfulness of music and song, a far less evidenced one concerns architecture. Evidence of a debate on architectural decoration challenges the established view of the formation of architecture (and decoration itself) in the Islamic world as a process lacking any theoretical or doctrinal basis, and provides new ground for a discussion of its development and meaning.

In Chapter 4 I elaborate why it can reasonably be assumed that a debate on architectural decoration took place under the rule of 'Umar Ibn 'Abd al-'Aziz around the year 100 AH/CE 718. This debate, which concerned the function of decoration in the mosque at Damascus, indicates the existence of a twofold and inherently contradictory attitude towards architectural decoration, which is clearly reflected in al-Jāḥiẓ's own narrative account of the Damascus mosque. On the one hand, al-Jāḥiẓ documents the preponderance of a favourable view of decoration, as attested to by the intricate adornment of the Umayyad monuments. On the other hand, al-Jāḥiẓ's account evidences the existence of a critical attitude based on the understood effects of ornamentation and decoration on the mind and soul (*al-bāl*) of the faithful.

What the terms of such a debate might have been is difficult to establish. I suggest that one can draw on al-Jāḥiẓ's *Kitāb al-Ḥayawān* to research the orientation of this debate. Indeed, a close reading shows that *Kitāb al-Ḥayawān* is framed by a world view built upon a central notion – that of *al-bayān* – which can provisionally be glossed as a theory of signification, or a semiology. According to al-Jāḥiẓ's semiotic view, the world is an intelligible system of signs. Decoration and architecture are part of this semiotic system. Ornamentation and architecture are used to commemorate and

glorify. Furthermore, as signs they have effects on the soul, which can be transformative, beneficial or harmful.

Al-Jāhīz seeks to provide an exhaustive study of all animals. He describes their languages, social lives, bodies, sexuality and habitats. As a Mutakallim – a representative of a branch of Muslim philosophy known as *al-kalām* that gives primacy to language (*al-kalām* means at once word, dialogue, argumentation and discussion) – al-Jāhīz's thought is based more on Arab poetry and language than on a theory of rationality. His study of each animal begins with its description as found in poetry and proverbs. These poetical characteristics occupy a prominent place in the book, and often stand as proof of what al-Jāhīz presents as truths about the lives and ways of animals. References to Greek philosophy are not rare, and Aristotle, whose book on animals is a model for al-Jāhīz, is dubbed *Ṣāhibu al-Mantiq*, the master of logics.¹⁰ Yet, despite these philosophical references, al-Jāhīz invariably grounds his arguments in religious beliefs. In fact, Islamic theology remains the ultimate source of evidence for his arguments about the lives and ways of animals.

Two characteristics of *Kitāb al-Ḥayawān* make it relevant to the study of art and architectural history. First, human beings are treated as animals and are studied as such by al-Jāhīz; their language, way of living, sexuality, and expressions are scrutinized. Second, al-Jāhīz develops a theory of *al-bayān* in the first part of the book, thus outlining the basic principle of creation. It is by way of *al-bayān* that all beings and things have a meaning and that human works and actions must consequently be 'read'. The theory of *al-bayān* is thus presented at the beginning of the book, in turn establishing the privileged position of human beings. As for our concerns, it is remarkable that al-Jāhīz cites calligraphy and architecture among the means of *al-bayān*.

ARCHITECTURE AND MEANING: AL-JĀHĪZ'S VIEW

To understand how, in the view of al-Jāhīz, architectural works or buildings engender meaning it is necessary to grasp the complex system of *al-bayān*. Al-Jāhīz's discussion of architectural decoration and adornment is inscribed within a broader argu-

ment about the importance of writing and the benefits of the book and a reflection on the place of meaning in language. In his view, the world is composed of living objects (*nāmi*: growing and reproducing), and inanimate objects (*jamād*). The living objects comprise animals and vegetation. There are four categories of animals – those that walk, swim, fly and crawl. All animals participate in *al-bayān*, and are of two genres – the ‘eloquent’ and the ‘speechless’ or ‘un-understandable’. This distinction is essential, for *al-bayān* is a basic dimension of life, or rather life in its entirety is a manifestation of *al-bayān*.

Moreover, *al-bayān* is basic to any relationship. It is a true expression of human needs and the intellectual means that enables people to find the solutions to their problems. As such, it is the cure for confusion, bewilderment and perplexity.¹¹ Al-Jāḥiẓ explains that God made human beings dependent on each other: kings depend on their guards, masters depend on slaves, the rich depend on the poor, and vice versa. He made all things of this world useful to human beings, who can wield their seductive powers over all other things and creatures.

The fact that certain people do not understand the language of others does not authorize them to conclude that the other’s language is not a language. For the diversity of civilizations and languages is a sign, *’āyat*, addressed to humankind and upon which one should reflect. Hence the Qur’an states:

And among His signs
Is the creation of the Heavens
And the earth, and the variations
In your languages
And your colours: verily
In that are signs
For those who know.¹²

The human incapacity to understand all communication between animals (for human beings do, in fact, understand some animal communication, such as signs of distress or anger) does not preclude them from participating in *al-bayān* according to their

specific modalities. Indeed, animals excel in some genres of *al-bayān* in which humans are less well versed. Al-Jāḥiẓ explains that the crucial difference between human beings and animals is that humans acquire *al-bayān* through learning and only then can actively practice it, while animals participate in it naturally and without any learning.

The universe and all the objects it contains are but visible beacons of the Creator and His wisdom; they are His *ḥikma*, His Wisdom and Signs.¹³ All things are evidence of that, and human beings are privileged as the only creations that possess the ability to be aware of His wisdom.¹⁴ All objects (things) can literally speak. Tabari thus reports that before receiving the revelation, ‘Whenever the Prophet walked in a street, and passed by a tree or a rock ... the tree or the rock greeted him.’¹⁵ That is, the tree or rock literally addressed him. Tabari also reports that whenever this happened, the prophet turned his head to the left and to the right to see whether someone was there beside him. But as there was no one nearby – only the trees and the rocks – he had to acknowledge that these inanimate objects were addressing him. But it is understood that rocks and trees speak only to the prophet.¹⁶

Al-bayān is the process of the production of meaning. It is the collection of all the means by which signification is produced. And if the utterance, *al-alfāṭ*, the sum of all existing words is limited, the meanings it produces are boundless. ‘The mind is the guide of the spirit, science is the guide of the mind, and *al-bayān* is the interpreter of science, *al-‘aqlu rā’idu ar-rūḥ, wa al-‘ilmu rā’idu al-‘aql, wa al-bayānu ṭarjumānu al-‘ilm.*’¹⁷ *Al-bayān*, then, is more than an instrument for understanding the world and uncovering its meaning; it is the means by which the spiritual can be reached, and a spiritual life can be accomplished.¹⁸

Al-bayān rests on four constituent elements – *al-lafẓ*, speech; *al-khaṭ*, writing; *al-‘aql*, calculation; and *al-ishāra*, the sign.¹⁹ There is a fifth basic component in the process of the production of meaning – *al-ḥāl*, ‘the state’ or condition of an object. Because the *al-ḥāl* (the state) of a mute object speaks, it can, as Edgar Allan Poe noted, ‘tell-tales’.

To distinguish friends from enemies
ask your eyes to tell you about hearts.

Paleness and poor colour indicate illness, and eyes tell about hearts.²⁰ To illustrate the extent of the domain of *al-ḥāl*, al-Jāḥiẓ cites many poems and, among others, a saying pronounced before the dead body of Alexander: 'He could speak before, but he is more telling today.'²¹ A corpse, in other words, can be more eloquent than a living person.

Al-ḥāl is also how a spider's net tells of an extraordinary perfection in weaving and, ultimately, of the perfection of its Creator. The world speaks to whomever knows how to seek meaning; the sky, the earth are signs of the wisdom and the might of God, who deposited His knowledge and many qualities in the organization of the heavens as in the voices of the animals, and the melodies of the songs of the birds. By way of *dalāla* or signs God conveys his kindness and might. Al-Jāḥiẓ stresses how the most delightful and playful birdsong is far beyond the ability of the best trained human beings.

Al-lafẓ, speech, is the first medium of signification. Animals are divided into two categories. The first comprises those who speak, the eloquent, the *faṣīḥ*, and the second those who are speechless, or whose speech is unintelligible, opaque, *a'jam*. In fact this division becomes more complex as al-Jāḥiẓ outlines his taxonomy of human and animal realms. In the human context, *al-a'jam* comes to mean 'those who speak a foreign language', for human beings are always *faṣīḥ* (eloquent), even when we do not understand them. On the other hand, animals are always *a'jam* (speechless/opaque) even if we do understand some of their messages. Yet animals cannot be considered mute. In al-Jāḥiẓ's words, 'mutes are found in all things except among animals.'²²

Human beings wield a plethora of languages through which they express themselves, and they possess different skills in the use of these languages. Arabs, for example, excel in poetry and therefore they put it above all other linguistic practices and means of communication.

Al-lafẓ (speech) and *al-khaṭ* (writing) are connected, rep-

resenting two different ways of using language. Al-Jāhiz underlines the existence of writing in all civilized societies, and in praising it, he reports on the merits of the book. His analytic strategy calls for a nuanced description of the differences between the art of speaking and that of writing. Drawing upon Aristotle's rhetoric and poetics, al-Jāhiz's analysis invokes numerous arguments ranging from the rhythm and defects of the voice, to the importance of attire in determining the success of the speaker and the choice of themes, and the necessity for diversification of style in a book.

The third component of *al-bayān* is *al-'aql*, or calculation. Its merits are clearly defined in the Qur'an, which states that the movement of the sun and moon rely on precise calculation. The Qur'an thus testifies to God's will to attribute to *al-'aql* a prominent role in signification.²³ Several verses mention *al-'aql* as a sign of God, and as such, a practical tool for human beings. Among these one can cite:

It is He who made the sun
 To be a shining glory
 And the moon to be a light
 (Of beauty), and measured out
 Stages for her; that ye might
 Know the number of years
 And the count (of time).
 Nowise did God create this
 But in truth and righteousness.
 (Thus) doth He explain His Signs
 In detail, for those who understand.
 Verily! In the alternation
 Of the Night and the Day,
 And in all that God
 Hath created, in the heavens
 And the earth, are Signs
 For those who fear Him.²⁴

The last component of *al-bayān* is *al-ishāra*, or gesture. Gesture is a crucial complement of the spoken word. It enhances the

communicative ability of the speaker, and gives speech the charms and seductive power to persuade. *Al-ishāra* is at once gesture, the action of the voice, and the power of dress, for an elegant orator will always appear more convincing than a 'poorly dressed, or dirty one'. *Al-lafz* (speech) thus relies entirely on gesture to make successful statements. But gesture is not a simple auxiliary to the spoken word. It is also the communication tool of the *al-khāṣṣa*, the elite. It is the language of confidentiality of the superior class, the language the elite uses to communicate secretly in the presence of the *al-ʿamma*, the populace. *Al-ishāra* (gesture) is a natural companion to the spoken word, an art of eloquence, and as impossible to decode a secret communication tool for the powerful and the elite.

Al-lafz (speech) depends not only on *al-ishāra* (gesture), but also on the voice. *Al-lafz* both refers to and relies on the voice to manifest itself. In order to come to life and signify, *al-lafz* depends on the action of the voice. Speech consequently lasts only as long as the voice that utters it endures, whereas *al-khaṭ*, or rather the written word, which depends on writing, has an independent existence and therefore the ability to last longer.

Al-khaṭ (writing) thus presents an advantage over *al-lafz* (speech). It is a means that endures, and therefore can be used to preserve memory of events, to amass and transmit knowledge from generation to generation, and to send messages from place to place independent of the limitations of the voice and memory of the human messenger. That is why all civilized societies, and all refined courts and states possess a scripture. Scripture is a warranty for agreements, contracts, peace, and trust between peoples.²⁵ And since numbers are also scripture, it is evident that merchants and trade rely entirely on the existence of *al-khaṭ*. It is not by accident that, when he first appeared to the Prophet of Islam, the Archangel Gabriel said:

Read! In the name of Thy Lord,
Who created, Created man out of a clot,
Of congealed blood:
Proclaim! And your Lord Is Most Bountiful

He Who taught by the pen,
 Taught man which he knew not.²⁶

Writing is thus elevated to sacred heights. This privileged status of writing is also confirmed by God's writing of the Tablets (of law) for Moses, and by His adjuration by the Pen in the *Sura* of the Pen:

By the Pen,
 And by the (Record)
 Which (men) write.²⁷

The pen is one of the two tongues (*al-qalamu aḥadu al-lisānian*), says al-Jāḥiẓ.²⁸ The pen, like the tongue, is both a physical tool/organ of communication, and a symbolic medium that makes possible communication. This definition of the pen and the tongue, at once symbolic and organic, is mirrored in the human body in the crucial role of the hand. The hand, whose role is essential to the practice of *al-ishāra* (gesture) and a necessary component of *al-lafẓ* (speech), is also fundamental in the manipulation of the pen.²⁹ This recourse to the hand inscribes the process of *al-bayān* in a necessary relationship to the body. The body occupies a prominent place in the accomplishment of *al-ishāra*, and thus a role in refining the clarity, precision and quality of *al-bayān*. *Al-khaṭ* (writing) may not rely only on the hand with regard to the clarity, readability or precision of what it communicates, yet its very existence depends on the hand.

The corporal condition of *al-bayān* is especially apparent when one considers the effects of vocal deficiency. That is why al-Jāḥiẓ begins his book *al-Bayān wa al-Tabyīn* by addressing the question of faltering. In al-Jāḥiẓ's view, the deficiency of stumbling and faltering is a hideous disease, almost impossible to conceal, and to which 'only death may bring a real relief'. It is also the best indicator of the intricate interconnections between soul, body and *al-bayān*. For stumbling and faltering are a test imposed by God, as is attested to in the Qur'an when Moses says:

Oh my Lord!
 Expand my breast;
 Ease my task for me;
 And loosen a knot from my tongue,
 So they might understand what I say.³⁰

The awareness of the corporal condition of *al-bayān*, which correlates voice and soul, reveals an uncanny facet of the aesthetic of speech. Al-Jāhīz notes that people do not mock ill reasoning whereas they always mock stumbling and faltering, and quotes many poems in support of this prejudice. This common attitude indicates the prominence of the body in the practice and aesthetic of *al-bayān*. This corporeal aesthetic suggests the existence of a process of identification between the speaker and the listener in the practice of *al-bayān*, and at the same time points to a lack of tolerance caused by such identification. Indeed, it evokes a feeling of fear – the fear of being disabled, or of a lack of mastery of the self. For stumbling is beyond personal control. In a word, stumbling is a curse. In contrast with *al-lafẓ* (speech) and the weaknesses of vocal enactment (such as stumbling, faltering), *al-khat* (writing) thus offers one further advantage.

Bodies are vehicles for expression, but they are also sites for the manifestation of *al-bayān* in its diverse forms. This is exemplified by the effects of castration on eunuchs. Bodies are the site and source of *gharā'iz*, instincts and desires, which are expressed by signs and behaviours. Among these driving forces are sexual desire and the pleasure of food. When the force that drives a desire meets an obstacle, as in the case of sexual desire for eunuchs, it does not fade or disappear, but becomes, says al-Jāhīz, like water obstructed by a dam. The obstruction diverts its path, but does not annihilate its working principle. And since the 'closest door to fornication is that of food' the eunuch shall divert his sexual desire onto eating.

When the organ which makes the mind engage with several kinds of pleasure and pain is made inoperative, you should know that those forces are not eliminated from the organism

and are not annihilated, but that they have been obstructed by a dam, and veiled, and that as long as they exist they will perform some action, for the action of any principle does not disappear unless its principle disappears, and when it is obstructed in one direction it floods into another.³¹

Al-Jāhīz explains that this is how eunuchs become gargantuan eaters – comparable to women rather than men. The diverting effects are accompanied by other signs, such as the loss of facial and body hair. More remarkably, the voices of eunuchs change, which makes them ‘recognizable even when they are out of sight’.³² Here I should mention that al-Jāhīz’s elaborate views on sexuality and sexual intercourse developed in *Kitāb al-Ḥayawān* contradict the assumption of the absence of a *scientia sexualis* in the Arab world. This assumption, introduced by Michel Foucault’s *Histoire de la Sexualité*, assumes that Western civilization ‘is undoubtedly the only civilization to practise a *scientia sexualis*’.³³ But the opposition introduced by Foucault between the civilizations practising the so-called *ars erotica* and those practising a *scientia sexualis* appears to be a rhetorical fallacy, for Arab civilization seems to have practised both.

An energetic logic underpins the system of signs observable in human nature. The metaphors al-Jāhīz used – dams, circulation and flooding – refer to what might be called a mechanic of fluids. Fluids circulate, overflow and flood. Their mechanism is visible in their behaviour, as is the case with all kinds of signs. Moreover, this mechanical energy is not confined to operating within the same individuals or the same species. Its circulation and effects breach the lines between species. Thus, says al-Jāhīz, when a dove broods a chicken egg the resulting chicken will be more intelligent than when brooded by a chicken, but when a chicken broods eggs of more refined species the resulting animals will be less refined.³⁴ Brooding, covering and heating incur associated qualities, for energy and the forces it generates are the sources of all qualities: beauty, and delicacy – in a word, aesthetics – are a matter of energy.

In al-Jāhīz’s view, desires, of which sexual coveting is the most powerful and common, are more than just bodily forces. Sexual

desire, for example, encompasses the desire to bear children, which is, in al-Jāḥiẓ's view, an important ingredient. Thus, 'some want children to be more numerous and have support [from them]'; while others want them for the preservation of their family line; to assist in the struggle against infidels; or simply for the survival of mankind.³⁵ One of the effects of the desire to procreate is the institution of marriage. Moreover, al-Jāḥiẓ states that most of the activities of men, their desire for possession, their search for skills, perfection, and embellishment are connected to, if not simply the result of, their desire to please women.³⁶ Desires therefore have a socializing function, and are at the origin of institutions. Hence human nature's most fundamental qualities and driving forces are not just in an ongoing dynamic relationship with human physical appearance and behaviour (as shown by the changes in the bodies of eunuchs), but are also in an isomorphic relationship with the organization of society and with the works of other human beings. Such driving forces and their 'mechanics of fluids', which imprint aesthetic qualities on the species, also mark and shape the appearance and functioning of animals, both at the level of the individual and the species. Energy, the driving force, is the thread linking all layers of creation – in other words, all the layers of *al-bayān*.

AESTHETIC, VARIETY AND EMOTION

'I know nothing more telling than a tomb, nothing more pleasant than a book, and nothing safer than solitude.'³⁷

When he comments on his own writing style in his book, al-Jāḥiẓ explains that humour and seriousness are inseparable. They are in a constant state of relation to one another, for a book dealing with serious matters only becomes tedious when there is no humour to make it more digestible. Al-Jāḥiẓ argues that al-Khalil's principle according to which: 'no one can learn grammar unless he learns many things he does not need,' that is, we need, paradoxically, what we do not need – should be generalized.³⁸ The unnecessary is necessary. Reading serious works can be exhausting, particularly if the reading is lengthy, but becomes enjoyable if the text is 'ornate'

and rendered palatable with amusing accounts and anecdotes. Repetition, explains al-Jāḥiẓ, can be noxious.

A beautiful woman had an affair with a very ugly slave. When she was asked how she could ever have sex with such an ugly man, she answered: 'Long lasting gaze, and proximity of couches.'³⁹ That is, repeated visual contact and excessive proximity. Repetition is more than tedious, it is blinding. In fact, even beauty cannot escape this fate when it is submitted to the chains of repetition. To counter the monotony of repetition and seriousness al-Jāḥiẓ calls for diversification and ornamentation. He thus writes:

And I have decided, but God alone is the source of success, to make this book ornate and detail its parts with rare specimens of poetry and stories to allow the reader to move (pleasantly) from one chapter to another, and from one genre to another; indeed, I have observed that people get tired even of melodious voices, beautiful songs, and clear musical instruments when the listening has lasted too long. And that rest is necessary, but can cause idiocy when it in turn lasts too long.⁴⁰

This is indeed a powerful plea for variety as the key to success in any aesthetic undertaking. Variety of genres; variety of rhythms; and variety of types of humour are the best guarantor of captivating the reader. Many scholars have also noted a similar concern for variety in architectural decoration.

VOICE, BODY AND EMOTION

The emotive and intellectual effects of the book, such as excitement and boredom, refer mostly to meaning, yet decoration and ornamentation play an important role in the quality of reading. This has compelled some writers to invest heavily in the embellishment of their books.

On the role of ornamentation, al-Jāḥiẓ's text reports and reflects the contrasting views and debates of his time, while remaining somewhat neutral – a neutrality one could interpret as ambivalence, or as an attempt to maintain a critical distance.

Hence, in the paragraph immediately preceding his report of his visit to the mosque of Damascus, al-Jāḥiẓ discusses the embellishment of religious books by the Manicheists or al-Zanādiqa (plural of Zindīq, the word is of Sasanian origin and also means heretic; ironically, this was the accusation brought against ‘Abd-Allah Ibn al-Muqaffa’, the Persian author of the celebrated *Kalila wa Dimna*). Commenting on al-Zanādiqa, he remarks that their richly ornate books neither deal with scientific, literary and philosophical subjects nor have any technical or practical purposes. He concludes that al-Zanādiqa did not seek to glorify knowledge or literature. Rather, for them the goal of decoration was to enhance religious experience and glorify faith. He writes:

Their approach is religious. It aims at glorifying their faith. Their expenditures in that respect are similar to those of the Zoroastrians for their temples of fire, and to those of the Christians for their golden statues. ... And thus they reserve that attention to their religious books, as the Christians adorn their churches. If that vision was appraised among Muslims, or if they considered it as an incitement to worship and meditation they incidentally would have surpassed what the Christians reached only with great effort.⁴¹

In the above passage, al-Jāḥiẓ provides a clear formulation of the debate on decoration, wealth and religious appropriateness. He states that Muslims intentionally refrain from richly ornamenting their religious buildings, for they consider that decoration is not ‘an incitement to worship and meditation’.⁴² In al-Jāḥiẓ’s words, the decoration of books by al-Zanādiqa, and that of fire temples by the Zoroastrians, or of statues and churches by the Christians respond to one and the same basic purpose – the glorification of faith. By contrast, al-Jāḥiẓ explains, Muslims consider that decoration is a hindrance to worship and meditation. Yet, al-Jāḥiẓ suggests that a more thoughtful reflection on the scope and effects of decoration might have enhanced the cause of Islam.

Before further exposing these views I should recall Umberto

Eco's epigraph in the Introduction to this book. Eco insists that by researching the ways in which each epoch solves its aesthetic problems we can truly hope to understand the sensibility and aesthetic consciousness of that epoch. Thus, when al-Jāḥiẓ draws parallels between architecture and the art of the book, or the effects of the voice and of decoration on the body, we should not question his parallels, but rather focus on the epistemic construct that makes them meaningful for the author and his contemporary readers. Our task should then be to try to reconstruct the conceptual underpinnings that helped the author give shape to his work. In other words, we do not have to share his views, or disagree with them, but apprehend and recreate them. When al-Jāḥiẓ draws parallels between the effects of the voice and the effects of decoration, and illustrates them mostly by those of the voice, this is because he and his contemporaries have better ways of describing the effects of the voice than those of decoration. The lack of material related to decoration in his demonstration neither diminishes the seriousness of the parallel in his eyes nor makes it less meaningful; indeed, it is probably because of that very lack that the parallel was drawn in the first place. Once again I should insist that grasping the relevance of these parallels in the conception of al-Jāḥiẓ does not require that we adhere to his views, but it is the best way to understand how he and his epoch solved the aesthetic problems they confronted.

How do these parallels work in connection with pleasure? Just as all aspects of the book concur in shaping the pleasure of the reader's experience, for capturing the attention of the reader remains the primary task, the corporal effects of the book resemble those of the voice. Al-Jāḥiẓ asserts:

The voice is amazing, and its effects on the face are a wonder. There are voices that kill, like thunder. Others please the mind, their pleasure can affect a man to such an extent that he would start dancing, and perhaps may throw himself from a high spot. Such is, for instance, the effect of melodious songs. There are voices that induce sadness, others that dispossess a man from his mind until he falls

unconscious, as can melodious voices and rhymed recitations. Yet, this never happens as an effect of the meaning, for in most cases people do not [even] understand the meaning of the speech. Once Mā-Sarjawayh started crying while listening to a recitation of the Qur'an by Abi-Khukh. When he was asked: 'how could you cry, and still refuse to believe [in the Qur'an]?' he answered: 'I cried only because of the moving strain (*al-shajā*).'

Similarly, it is with [chanting] voices that children are put to bed.⁴³

The voice affects the soul and body of the listener. It can give pleasure to one, strike another. It penetrates the listener and operates inside his body. This physical intrusion is essential to its effectiveness. According to Ibn 'Abd Rabbih, a ninth-century Andalusian author (CE 246–328):

Physicians claim that the melodious voice penetrates the body, and circulates through the veins. Then it purifies the blood, lets the heart rest, gives delight to the soul, moves the limbs, and makes movement pleasant. That is why they warn against putting children to bed while they are crying, and recommend music and dance before putting them to bed.⁴⁴

Further on, Ibn 'Abd Rabbih states that:

Philosophers believe that *an-nagham*, melody, is [born from] an overflow of *al-mantiq*, the faculty of speech, that the tongue could not express by the ordinary principle of division (*at-taqī'* – scansion of speech).⁴⁵ Yet nature manifested it (that excess) in melodies based on the principle of recurrence (and chanting). When melody appeared the mind loved it and the soul longed for it; that is why Plato said that the soul should not be impeached of love. Don't you see that when craftsmen fear abatement for their bodies they make recourse to songs, and that that relaxes their minds?⁴⁶

Harmonious melodies have the most positive effects on the mind. They can help one reach the best of this world and the other. They contribute to the shaping of the mind and acquisition of good manners. Such melodies reconcile the fighters, appease the angry, and make the harsh heart tender. In a word, there is nothing sweeter to the heart and more puzzling for the mind than a nice voice.

Hence, it is no wonder that people hold opposing opinions about singing. One party, the majority of the people of *al-Ḥijāz*, the central part of contemporary Saudi Arabia, approved of song, while another party, the majority of Iraqis, disapproved of it.⁴⁷ To support its position the first party stated that the origin of songs is poetry, and reports ḥadīths, or traditions of the prophet recommending the use of poetry, as when the prophet asked Ḥassān Ibn Thābit, a poet, to engage in a war of poetry against the Arabian tribe, Abi 'Abd Manāf. The prophet is reported to have said that poems by Ḥassān would be more offensive than spears. The people of *al-Ḥijāz* argued as well that most poems by Ḥassān were sung. In another saying, the prophet is reported to have recommended to his wife 'Ā'icha to use songs at weddings.⁴⁸ While those in favour of songs based their opinion on the authority of the prophet, their opponents cited the Qur'an, quoting a verse that admonished 'those who buy empty speech with the intention of leading one astray from the path of good'. They claimed that songs burn the heart, disturb the mind and stimulate entertainment and distraction. However, Ibn 'Abd Rabbih argues that the Qur'anic verse invoked by the majority of Iraqis was radically misinterpreted, for it in no way relates to songs. Rather, the verse in historical context can be understood as an attack on those individuals who argued against the Qur'an on the basis of ancient tales and stories found in books they bought at the market. In short, Ibn 'Abd Rabbih agreed with most authorities that songs cannot be condemned on religious grounds.

What is outlined and suggested in al-Jāḥiẓ's writings on the voice is extensively developed in the work of Ibn 'Abd Rabbih. The latter does not discuss the voice in general but focuses on the melodious voice and its product, the song. While al-Jāḥiẓ

illustrates the disastrous effect of the voice by comparing it with the murderous sound of thunder, Ibn 'Abd Rabbih suggests that it is the human voice, itself, that can kill. He cites the story of a slave woman of the Umayyad Caliph Yazid and her lover. Meeting his beloved after a long separation, the lover is literally killed by her singing in the presence of the caliph.⁴⁹

It is remarkable that the terms of the debate on the lawfulness of song and its effects on the mind are fully consistent with those invoked by al-Jāhīz in his account of 'Umar Ibn 'Abd al-'Aziz and the great mosque in Damascus. The effect on the mind, its puzzlement and excitement, were similarly invoked both to condemn the decoration of the Umayyad mosque and to ban singing. Yet, in both cases, it is the opposite party, the party promoting moderation and pleasure rather than austere renunciation that prevails. It seems, therefore, plausible to assert that multiple debates about aesthetic questions took place in the Muslim empire at the end of the first century of the al-Hijra/eighth century CE.

Origin of Songs and Architecture

Chronologically, the rise of the art of the song in Islamic history appears to be contemporaneous with that of architecture. The first reported singer is a Persian slave called Ṭuwais, who is said to have started his career during the time of 'Uthman, the third caliph of the prophet. This is not long after the early development of the architecture of the rising Islamic empire, whether we attribute its rise to the second Caliph 'Umar, or to Ziyād ibn Abīhi, the governor of Mu'awiya and the founder of the Umayyad dynasty. A further parallel lies in the fact that it is a Persian who introduces the art of the song to Arabia and, in Arab mythology, architecture is borrowed from the Persians.

As governor of al-Madīna 'Umar Ibn 'Abd al-'Aziz played an important role in the development of the architecture of mosques.⁵⁰ Ibn 'Abd Rabbih recounts a story in which an Arab dignitary complains to 'Umar about Ṭuwais the singer, who had publicly mocked him. After he heard the story, and learnt that the plaintiff had previously insulted the singer, 'Umar Ibn 'Abd al-'Aziz pronounced a non suit against the plaintiff.⁵¹ In the context in

which Ibn ‘Abd Rabbih reports it, the story appears important not because ‘Umar is once more presented as a model of justice, but because it is an explicit endorsement by the pious governor and future caliph of the lawfulness of song.

The question of the lawfulness of singing is explicitly evoked in other accounts by the same author, in particular in connection with Mu‘awiya, the first Umayyad caliph. The latter is said to have been opposed to the art of singing during the beginning of his reign, which he zealously condemned:

He reproached ‘Abd Allah Ibn Ja‘far for listening to songs. One year Mu‘awiya journeyed to al-Madīna to accomplish his pilgrimage. One night, while walking near the house of ‘Abd Allah Ibn Ja‘far, he heard someone singing. He stopped there, listened for one hour, and left saying ‘may God forgive me, may God forgive me’. When he left his house at the end of that night he again passed by the house of ‘Abd Allah Ibn Ja‘far, who was then performing his ritual prayer. Curious, Mu‘awiya stopped to listen to his reading of the Qur’an. He then thanked God and said: ‘They mix a good action with a bad one, God might forgive them.’

When Ja‘far learned of this, he invited Mu‘awiya to his home for dinner. He also brought Ibn al-Şayyad, the singer, and asked him to start singing as soon as Mu‘awiya began to eat. When Mu‘awiya began eating, Ibn al-Şayyad started singing. ... Mu‘awiya was so pleased by the song that he stopped eating and started tapping the floor with his feet. It is then that ‘Abd-Allah Ibn Ja‘far asked him: ‘Oh prince of the faithful, this is the best of poetry, sung in the best way, how do you judge it?’ Mu‘awiya answered: ‘there is no harm in the best of poetry paired with the best of melodies.’

The story continues with ‘Abd-Allah Ibn Ja‘far travelling to Damascus to visit Mu‘awiya, who hosts him in his own house. Mu‘awiya was so charming to his guest that his wife became jealous:

One night his wife heard their guest singing. So she went to

Mu'awiya and reproached him for having invited such a degenerate man in his *hurum*, his private and sacred home. When Mu'awiya heard the songs of his guest, he was moved and told this wife: by God, I am hearing something that would move mountains, and I think it is performed by djinns. At night he heard 'Abd-Allah reading the Qur'an for his prayer, he then called Fakhita, his wife, and told her: 'now listen to this, those are my people, kings in the day, and priests at night.'⁵²

How ought one to interpret Mu'awiya's change of attitude? Is this story a veridical account of the conversion of a historical character, of his change of opinion, or should it be read symbolically? It is worth noticing that in this case the author of the report is not an enemy of the Umayyads. He is undoubtedly writing between the third and fourth century AH (ninth-tenth century CE), but he is Andalusian, which means that he is Umayyad. Hence, his account should not be read as derogatory. On the contrary, the mentioning of Mu'awiya's name projects a positive light on the action it narrates, for as the founder of the Umayyad dynasty Mu'awiya was a particularly popular figure in Andalusia in his day.

Such contrasting accounts of the role and place of songs and music point to the existence of a controversy about their compatibility with faith and piety, if not about their lawfulness. The state figures evoked – Mu'awiya, and 'Umar – were also involved in the development of Umayyad architecture. Both Mu'awiya, the apt politician, and 'Umar, the pious caliph, supported the lawfulness of songs and implicitly, that of the pleasure of aesthetic delectation. We can therefore conclude that the Muslim authorities ruled out an aesthetic puritanism in favour of an aesthetic of pleasure – but, as al-Jāhīz might have said, an aesthetic that still preserved decency.

AL-BAYĀN, ARCHITECTURE AND COMMEMORATION

Given the centrality of *al-bayān* to the existence and the functioning of society, and its role in both the temporal and spatial

transmission of information in commemorating glorious deeds, every society must elect to develop one genre of expression of *al-bayān*. Thus it is not surprising that ancient peoples

used to incise inscriptions on rocks, to sculpt them on stones, and to compose them as ornaments on buildings – the writing could be protruding or incised – when it was the commemoration of important events, or of an important agreement, or of a warning of great wisdom, or of the commemoration of a noble. That is why they made inscriptions on the dome at Ghumdān, on the door of al-Qayrawān, on the door of Samarkand, on the Stella of Ma'rib, in the corner of al-Mushaqqir, on the al-Ablaq the unique, on the door of ar-Rahā. They chose the most famous places, and the most celebrated [by religions] spots and they put the inscriptions in the places that are the most remote from erosion, the best protected from obliteration, and the best exposed to view, and which are impossible to forget.⁵³

It is worth noting that the locations al-Jāhīz mentioned, with Samarkand to the east and Qayrawān to the west, symbolize the geographic extension of the Islamic empire at the time. More interesting is the mention of Ma'rib, al-Ablaq and Ghumdān, for it suggests an awareness of a certain continuity of pre-Islamic and Islamic Arabian culture. This awareness is essential to the interpretation of the role of pre-Islamic Arabian art in the formation of Islamic culture, which contradicts the ordinary assumption of the simple rejection of pre-Islamic culture by Muslims.⁵⁴

To commemorate their glorious deeds, the Arabs chose poetry as their favoured modality of *al-bayān*:

In their age of ignorance, to commemorate Arabs intelligently used poetry. ... The Persians used to seal their exploits with buildings. ... Later on, Arabs wanted to share building with the Persians, while keeping poetry for themselves. They then built Ghumdān, the *ka'ba* at Najrān,

the palace at Mārid, the palace at Ma'rib, the palace at ash-Shu'ūb, and al-Ablaq the unique.⁵⁵

Architecture is therefore comparable to poetry, and poetry is organically linked to song.⁵⁶ Adonis writes:

Recitation of poetry is a form of song. The Arab literary tradition is full of signs confirming this. The poets who recite their work are often compared to singing birds and their verses to birdsong. 'Song is the leading-rein of poetry,' according to a well-known expression, while Hassān Ibn Thābit (d. CE 674), 'the poet of the prophet', has an equally famous verse:

Sing in every poem you compose
that song is poetry's domain.⁵⁷

Like poetry architecture is a means of commemoration, hence a means of *al-bayān*. As such, it participates in the production of meaning and expression that is basic to the functioning of society. Furthermore, as a means of commemoration, architecture is an expression of power. That is why buildings come to symbolize rulers and dynasties. That is also why, to obliterate the memory of their enemies, kings destroy the buildings that embody their memory. Al-Jāḥiẓ explains that the pre-Islamic kings had the custom of destroying the palaces and fortresses of their foes, and Muslim rulers adopted this practice. Thus, the caliph 'Uthman is said to have destroyed the tower and palaces at Ghumdān; Ziyād, the illegitimate brother of Mu'awiya, is said to have destroyed Ibn 'Āmir's palace and caravanserai; and the 'Abbasids were purported to have destroyed the works of the Umayyads in Syria-Palestine.⁵⁸

The fact that architecture may be used as a symbolic manifestation of power and as a means of commemoration entails a factor of vulnerability. But above all, architecture is a part of *al-bayān*, the general structure of meaning and expression available to human beings. Is it possible to define the components of *al-bayān* at work in architecture? This question is crucial if one is to understand the specific features of architectural semiosis. It is

evident that architecture cannot have recourse to *al-lafz* (speech), or to *al-ishāra* (gesture), for both are inseparable from the human body. The third element, *al-khaṭ* (writing) can be employed in architecture, but only as an extra (surplus), something added as a decoration or inscription and not as a basic architectural component. By contrast, the two remaining components of *al-bayān* are clearly compatible with the nature of architecture.

Al-ḥāl (state, condition) is a component of *al-bayān* that clearly plays a role in architecture. Al-Jāḥiẓ says that in Persia some architectural forms and elements were reserved for the elite and, as such, became symbolic (of status).⁵⁹ It is the ability to recognize their 'state' (*ḥāl*), and connect them to a specific meaning that makes this symbolic process possible. Their *al-ḥāl*, the state of these forms and elements, is what makes them an expression of *al-bayān*. This is only a conventional architectural form of *al-bayān*. *Al-ḥāl* is at its best in the expression of wealth, health and their opposites.⁶⁰

But *al-'aqd* (calculation) is likely the subtler and more prevalent element of the architectural expression of *al-bayān*. Calculation would appear a central means of *al-bayān* in architecture for two reasons. The symbolic reference to the *ka'ba* attests to this centrality. Al-Jāḥiẓ states, 'In the al-Jāhiliyya, they [the Arabs] did not build square houses out of respect for the *ka'ba*. Furthermore the Arabs call *ka'ba* any square house; hence the *ka'ba* of Najrān.'⁶¹

This is a clear reference to calculation, for however simple a square may be, it refers to the basic notions of measurement and calculation. Perhaps the very geometric character of the architecture of the Islamic world is itself the best proof of the importance of *al-'aqd* to architectural signification. For, even though few monuments have been subjected to rigorous analysis,

the cases where such work has been done show that an emphasis on exact mensuration and on complex correlations stamps the best Islamic architecture of almost any place and period. ... The square root of two is used to set up the design of the so-called Tomb of the Samanids in tenth-century Bukhara, the thirteenth-century Mustansirya

madrasa in Baghdad, and the fourteenth-century tomb of the Amir Kilani in Jerusalem. Proportional ratios of 3:2 occur almost as a leitmotif in ninth-century 'Abbasid architecture in Iraq. A grid of equilateral triangles generates the designs of the window grilles in the eighth-century Umayyad mosque in Damascus.⁶²

The second argument pointing to the centrality of *al-'aql* is that architecture is comparable only to poetry and song, and poetry is subject to strict formal rules and precise calculation.

One can find evidence that there was an awareness of and even scholarly reflection on the fact that *al-'aql* and *al-ḥāl* produce meaning in any Arabic description of buildings. Prime examples are the famous *Iklīl* by al-Hamadhāni and the vivid, if not learned, description of Constantinople by Haroun, an Arab prisoner who visited the city in the ninth century CE. The importance of *al-ḥāl* is strikingly apparent. Even a casual reading of al-Hamadhāni's and Haroun's works displays the sense that some form of *al-bayān* is produced and attained through *al-ḥāl* in the perception of architectural works. To mention the most obvious, the symbolism of building materials is notable. Gold, silver, bronze, precious and semi-precious stones, and marble are always recognized and singled out in their descriptions. Both al-Hamadhāni and Haroun speak of golden doors, silver doors, and marble revetment to emphasize the wealth of buildings; and it goes without saying that in evoking these materials, they consciously both confirm and reinforce their symbolism.

It is easy to deduce a hierarchy of construction materials and even a viewer unfamiliar with the concerns of the architect can grasp its symbolism. In fact, any material – be it marble or mud brick, gold or bronze, ashlar or semiprecious stone, common or precious wood, plaster or mosaics – conveys meaning. Materials work as signifiers. Their meaning refers to a symbolic hierarchy of wealth. But this symbolism is just one level of signification. A material, like gold or mosaics, first signifies as a material by reference to this symbolism. But the work, the quality of the treatment of the material, and the refinement of its ornament-

tation add further layers of meaning. That is why the signifieds conveyed by these signifiers (materials) are not, and should not be limited to a particular meaning. In the process of signification, signifiers and signifieds are related by a flexible connection, and the process of signification is always susceptible to change and renewal. Besides, meaning is not determined only by the relation between signifier and signified; it is also affected by the context of the signifier.⁶³

Indeed, the process of signification is open not only to slight changes but also to contradictory meanings. As, for instance, in Thomas More's *Utopia* where, because of its uselessness, gold is used to make chains for prisoners, and iron to make jewellery: materials may convey opposite meanings for different people. Hence, the great mosque at Damascus may have, at the same time, conveyed a sense of the glory of Islam and deep gratitude to God for the Umayyads, and just the opposite, a sense of opulence and arrogance, to their foes.⁶⁴ Similar examples abound in architectural history. The dispute about church decoration in medieval France between Abbot Suger and the school of Saint Bernard is famous but not unique.⁶⁵ And the phenomenon is more common than it may appear. Is it not true that what some call kitsch is refinement for others, and what is pure for some looks austere for others? Is it not true that even the language of modern architecture is not perceived as conveying any meaning by many critics?⁶⁶

The following passage from Haroun's description of Constantinople is more eloquent than many learned comments about meaning in architecture.

To the left of the gateway is the imperial church, which has ten doors, four of which are in gold, and the remaining six in silver. On the balcony (*al-maqşura*) where the Emperor stays, a space of four square cubits is inlaid with pearls and rubies. The cushion on which he rests his arms is equally adorned with pearls and rubies. The door of the altar has four columns of monolith marble. The altar before which the priest says his prayers has six spans in length and six in width. It is a block of wood of aloe inlaid with pearls and

rubies, before which officiates the imperial priest. The church has four courtyards, each two hundreds steps long, and one hundred wide.⁶⁷

Haroun describes Byzantine buildings and, of course, the architectural symbolism of which he speaks is Christian. But his perception is that of an Arab. There is, it has been said, the possibility that Haroun might have been a Christian Arab. Furthermore, his description of Constantinople has been appropriated by a Muslim author, Ibn Rusteh.⁶⁸ We can therefore assume with certainty that this perception was not foreign to Muslims and that the latter were accustomed to perceiving buildings as conveying an understandable symbolism.

Another relevant aspect of Haroun's text is his mention of the dimensions of numerous buildings. More remarkably all these dimensions are often given as proportions: the courtyards of the church are 200 by 100 steps, the altar is six by six spans, the *maqṣura* (note the use of the Arabic word designating a place reserved to the ruler in the mosque) is four square cubits. Equally remarkable is the use of different units of measure. Haroun's careful attention to measurements and proportion, and his decision to report them is testament to a mental perceptual habit, and to his confidence that the Arab readers of his account would understand the meaning conveyed by measurement and proportion. The presupposition of a shared understanding is indispensable to any collective perception and symbolism. It thus seems reasonable to suppose that for early Arab authors, measurement and proportion, *al-'aqd* in the terminology of al-Jāḥiẓ, were considered, not unlike *al-hāl*, as conveying architectural meaning. We can then conclude that in al-Jāḥiẓ's view, in addition to sharing the symbolic function of memorializing and glorifying, poetry and architecture proceed from the same procedure of *al-bayān*, namely *al-'aqd*, or calculation.

3

Architecture and Poetics

[When] Al-‘Ajjāj was told that he did not excel in satire he answered: ‘we have discernment that prevents us from being unjust, and a noble descent that protects us from injustice. Do you know a builder who cannot also destroy with art?’ But such an assertion is mistaken, and the statement of al-‘Ajjāj concerning satire and eulogy is false. Eulogy is building (*binā*’) and satire is building (*binā*’), but a good builder in one genre is not necessarily good in another.

Ibn Qutayba (d. 276 AH/CE 889)¹

When asking in what manner the mental habit induced by Early and High Scholasticism may have affected the formation of Early and High Gothic architecture, we shall do well to disregard the notional content of the doctrine and to concentrate, to borrow a term from the schoolmen themselves, upon its *modus operandi*.

Erwin Panofsky²

Asked about the meaning of his painting, the contemporary Moroccan artist Mohammed Cheb’a once told me: ‘If I simply had something to say or an idea to communicate, I would have just said it in a few words instead of spending months on a painting.’³ This notion that art is not simply a medium for the expression of ideas encapsulates an attitude that finds wide resonance among artists in and outside the Islamic world. It suggests that rather than reflecting a philosophical idea or stating something about reality, art functions differently. Mohammed Cheb’a emphasizes the

aesthetic form of his work – a painting – over its meaning. Like Paul Cézanne he sees the world through forms and colours. He claims to think visually. Of course his paintings also aim to encompass and convey meaning, but as the painter would say, meaning cannot exhaust the aesthetic function of art. Cheb'a views his works as an art of poetics, in Roman Jakobson's sense, in that meaning is ambiguous and secondary to form.

The singularity of architecture is that it, too, functions poetically. I argue that in the art of the Islamic world the difference between intellectual, visual and artistic 'subject matter' is artificial. For, while it is inaccurate and reductive to view the architecture of the Islamic world as the reflection of theological or philosophical views, or according to the same narrative prisms through which ancient art has been analysed, it is equally inadequate to approach architectural meaning through the visual and artistic registers alone. To understand this more fully, we can reflect on what modern abstract art taught us about the fallacy of separating intellectual and artistic (or visual) meaning. This separation was imposed by the view that art is representation, and that narrative is its subject matter.

Cheb'a's comment that art is not simply a medium for the expression of ideas suggests that art functions differently. Because the artist thinks visually, he does not simply translate discursive thoughts into visual compositions. Even Magritte, whose works are considered deep philosophical reflections – as exemplified by his painting 'Ceci n'est pas une pipe'⁴ – is above all a painter. Like Escher, his fascinating and paradoxical 'visual thoughts' are far more striking than their verbal interpretation/formulation. Evidently, their captivating power resides more in their visual logic than in their implicit theoretical statements. In that respect it is important to keep in mind the magical status of the image. E. H. Gombrich begins to articulate that magic when he writes:

suppose we take a picture of our favourite champion from today's paper – would we enjoy taking a needle and poking out the eyes? I do not think so. However well I know with

my waking thoughts that what I do to his picture makes no difference to my friend or hero, I still feel a vague reluctance to harm it. Somewhere there remains the absurd feeling that what one does to the picture is done to the person it represents.⁵

Art works act on the beholder's mind not only on the intellectual level, but also, and more deeply, on the level of his or her unconscious. Their effects are certainly not limited to the didactic or pleasure inducing functions of art.

Interestingly the famous poet known as Majnun Layla, from the Umayyad period, presents us with an even more complex notion of a picture. In one of his poems he describes how after drawing the face of his beloved on the ground he finds himself foolishly addressing the image depicted on the earth as if it were the beloved in flesh and blood, and how his pain acutely lingers as the unrelenting earthen figure of dust does not deign to reply to his complaints. The poem reads:

I draw a portrait of her on the
 ground and I cry, my heart in pain
 And I complain to her of leaving me
 the complaint of one who is greatly afflicted
 And I tell her all I suffered and all my passion
 and love of complaining to the earth
 Love overwhelms me in Layla's land
 and I start complaining to her my inflaming love
 And the clouds of my eyes rain on the earth
 my heart in sadness and pain
 And I cry to the ruins my overwhelming love
 and my tears running in floods
 I talk to a picture of her drawn on the earth
 as if the earth were listening to my words
 As if I were at her home complaining to her of my pain,
 whereas my speech is [addressed] to the earth
 Nobody answers to my words
 and [I] the plaintiff does not answer in my own words

And I return disappointed, my tears
 pouring as raining clouds
 Because I really am madly in love with her
 and my heart from this love is in pain.⁶

MODUS OPERANDI

As I argued in the Introduction, architecture, understood as a language, functions in a poetical mode, in which the poetic function, without being the sole function, is nonetheless the dominant one. All other linguistic functions (such as denotative, symbolic and usage) coexist in architectural works, but the supremacy of the poetic function renders them ambiguous. This conception, which is based on the theory of poetics developed by Roman Jakobson, is opposed to architectural functionalism and its necessary spatial heterotopy. Against the functionalist valorization of readability, it ascribes a central role to ambiguity. I therefore argue that to unravel the meaning of the architecture of the Islamic world, a poetic approach is necessary.

In delineating the pre-eminence of the poetic function in architectural design, it is necessary first to attend to the dominant view according to which certain elements of the architecture of the Islamic world are viewed as signifiers of Islamic thought. Inspired by a curious misreading of Erwin Panofsky's *Gothic Architecture and Scholasticism*, many scholars have argued that, in the Islamic world, ornament is a reflection of contemporary attitudes.⁷ Critiquing this common view, Oleg Grabar has pointed to the two themes in Islamic thought most cited by these scholars. The first is the atomistic philosophy inherited from the Greeks – according to which,

The composition of atoms into things ... is a divine prerogative, but artists, who must not compete with God, are allowed to organize these atoms in any arbitrary way they wish. Thus the free and imaginative variations of Islamic ornament or unusual combinations of motifs were seen as reflections of a philosophical doctrine on the nature of reality.⁸

And the second is the theme of the impermanency of the world, which, according to Louis Massignon, is based on the assumption that forms and figures do not exist as such, for only God is permanent. This implies that nature as such does not exist, and explains why forms and figures are denied a state of permanency in the art of Islamic societies.⁹ Oleg Grabar rightly questions the supposed influence of such thought on architecture in the Islamic world:

One may wonder whether, for this moment in Islamic history, it is entirely appropriate to find in mystical thought and imagery an explanation or even a parallel for a comparatively common ornamental tendency. Scientific or pseudo-scientific theory, while more attractive to explain the actual character of the arts, is equally difficult to imagine as having the necessary impact at a variety of social and economic levels. Furthermore, the main scientific achievement of Islamic culture is later than our period and it coincides better with a later development of ornament.¹⁰

Consistent with Grabar's criticism one can note that, in Panofsky's view, the relationship between Gothic architecture and scholastic philosophy is neither one of mere parallelism, nor does it suggest a simple transference of knowledge from one domain to another. Rather, Panofsky speaks of the coincidence of 'mental habits' – of preponderant principles that regulate diverse human activities in similar ways – hinting at the possibility of a remarkably different conception of the relationship between art and Islamic thought:

In contrast to a mere parallelism, the connection which I have in mind is a genuine cause-and-effect relation; but in contrast to an individual relation, this cause-and-effect relation comes about by diffusion rather than by direct impact. It comes about by the spreading of what may be called, for want of a better term, a mental habit – reducing this overworked cliché to its precise Scholastic sense as a 'principle that regulates the act', *principium importans*

ordinem ad actum. ... Such mental habits are at work in all and every civilization.¹¹

It is clear that Panofsky does not conceive of this ‘connection’ as the influence of one intellectual domain on another, but rather as the manifestation of the same intellectual processes at work in different realms of human creative activity. Likewise, in the preface to the French translation of Panofsky’s book, Pierre Bourdieu comments that the same *modus operandi* at work in Gothic architecture and in scholasticism is also discernible in Gothic illumination.¹²

The influence of mental habits can also, perhaps, be traced in certain simultaneous developments in the arts and sciences. The similitude of artistic innovations and scientific revolution in the nineteenth and twentieth centuries first evoked by Pierre Francastel in his *Histoire de la Peinture française* was later described by Jacques Barzun:

Science became mathematical, statistical, abstract, invisible. It was too difficult for any but those born predisposed to think in those ways. And by a remarkable parallel, the same thing happened in the arts. Impressionism, and subsequent movements denied the beholder simple representative effects. Imitation was forbidden under pain of indictment for philistinism and academicism. Symbol, allusion, diagram hints became the only possible modes of conceiving art. ...

... In Cubism, in Abstract, and finally in every variety of non-figurative art, we recognize the movement of mind that took science from the lever and the lump of quartz to the particles, waves, orbits, and magnetic fields that are inferred and seen.

And in harmony with Panofsky’s view of related mental habits influencing distinct fields, Barzun adds: ‘There is no evidence that the artists who took the path away from nature to symbol were tempted by curiosity about the work of Bohr and Planck or by envy of the Nobel Prize in Physics.’¹³ It is remarkable that several works on the architecture of the Islamic world inspired by Panofsky did

not develop the idea of ‘mental habits’, and instead sought to explore connections between the ‘notional content’ of Islamic thought and its expression in art and architecture.¹⁴ Panofsky’s concept of ‘mental processes’ at work in different forms of human expression was thus widely misread as the transference of philosophical notions and ideas into the field of visual art. This misunderstanding is symptomatic of a widespread attitude, which consists in treating art as a mere reflection of ideas and philosophical views.¹⁵ In this regard the work of Garth Fowden on the frescoes of an Umayyad bathhouse represents an exception. Here is how he describes these paintings:

Quṣayr ‘Amra’s frescoes were made up of numerous separate paintings, sometimes with no discernible shared subject matter to connect them with the other paintings, even those immediately adjacent. Yet all were at the same time loosely linked together by the architectural framework that contained them, and by a general theme of princely panegyric or at least celebration of princely life. The resemblance to the *qaṣīda* extended, in other words, beyond the shared themes of love, hunting, and panegyric ..., to embrace also a fundamental structural affinity.¹⁶

In harmony with Panofsky’s view my hypothesis is that the principles of design of the early architecture of the Islamic world (geometricism and ambiguity) are in a structural relation with the principles of the Arabic theory of language, as developed in the theory of permutations by al-Khalil in *Kitāb al-‘Ain*, and of poetics, as developed (allegedly by the same author) in the lost *Kitāb al-‘Arūd*. My argument about art, which borrows from modern art theory, is also indebted to Panofsky’s notion of a *modus operandi*. More importantly, this approach was ‘imposed on me’ by al-Jāhiz’s theory of *al-bayān* and his view of architecture and decoration as particular forms of its expressions. By directing my attention to a theory of symbolic forms, al-Jāhiz’s view more than stimulated my reflection; it shaped my reflection in terms of architectural meaning and poetics.

In the previous chapter I suggested that in al-Jāhiz's view, architecture and poetry have a structural connection, and besides sharing the symbolic function of memorializing and celebrating they proceed from the same mechanism of *al-bayān*, namely *al-'aql* or calculation. What is the nature of this connection? In other words, is this connection a simple similarity, inasmuch as they are both elements of *al-bayān*, or do architecture and poetry share some fundamental structural features? In what follows, I attempt to answer this question in the light of Panofsky's observation, namely showing the common 'mental processes' at work in both Arabic poetics and the early architecture of the Islamic world. But since Arabic poetics and theory of language of the eighth to ninth centuries CE are known to only a few specialists, I must first introduce them.

AL-KHALIL'S THEORY OF LANGUAGE

Most scholars agree that al-Khalil Ibn Ahmad (100–75 AH/CE 718–91) was the first author to develop a theory of the Arabic language. He is author of the first Arabic dictionary, and creator of the science of poetic versification called *al-'arūd*. His work constitutes a true epistemic break. Prior to his reflection on language, and to his dictionary, Arabic knowledge of language was pragmatic and asystematic. Works on language were of two kinds. The first was represented by books comprised of arbitrary lists of words grouped together without any organizing principle. The second presented a new form and an organizing principle – the choice of a theme. Most works of this genre were thematic booklets in which authors gathered all possible words related to a particular subject, such as prayer, or trade. The books on the horse and the camel by al-Aṣma'i are good examples of this thematic type of work.¹⁷ It is clear that these works represented a preliminary step forward in the study of language.

The ultimate breakthrough towards the development of a theory of language was realized by al-Khalil Ibn Ahmad (known as al-Khalil). There is a debate about his authorship of the *Kitāb al-'Ayn*, the first Arabic dictionary, but most authorities agree that at the very least he wrote the introduction and designed its

structure. He is also thought to be responsible for the systematization of Arabic grammar.¹⁸ Departing from all previous attempts at making dictionaries, which were based on classifications of words grouped according to the seemingly arbitrary selection of a particular theme, al-Khalil begins his book by stating that individual words are intelligible constructions, and that the Arabic language is built on a formal order.

There are a series of comprehensible principles upon which Arabic words were created, and according to which they function. The formulation of these principles appears therefore to be a major task in the project of establishing a systematic knowledge of the Arabic language. The basic principle of al-Khalil's theory is that Arabic words are obtained by the *combination of a limited number of ḥurūf, or letters*. Al-Khalil points out that Arabic words, or rather their roots, are composed of two, three, four, or five of the 29 letters.

His dictionary is not arranged alphabetically, but according to a taxonomy, which is now known by al-Khalil's name. It is a phonetic order starting with the letter 'ayn, hence the title of the dictionary. In al-Khalil's view, the letter 'ayn is the deepest pharyngeal *ḥarf*, producing the deepest vocal sound. It should therefore be the opening letter of the dictionary, and all other *ḥurūf* (plural of *ḥarf*) should take their rank according to their phonetic proximity to it. The *ḥurūf* are then classified in nine phonetic groups: *ḥalqīya, lahwiya, shajariya, asaliya, niṭ'īya, lathwiya, dhalqīya, shafawiya, hawā'īya*.¹⁹ This classification comes close to the modern taxonomy of pharyngeal, velars, palatals, dentals and labials. The *ḥurūf* are assembled in these phonetic groups, and the dictionary follows this order. The dictionary is consequently difficult to use, for to find a word in the dictionary the reader must first deconstruct the word, determine the order of its letters according to al-Khalil's taxonomy, then take the first of them in that order and, finally, look under the corresponding entry.

In the case of words with roots composed of two *ḥurūf* (that is words with two radicals), each pair of letters of the Arabic alphabet offers a combination, and each of these combinations produces two possible words due to the principle of permutation.

For instance, the combination of *l* and *m* offers the permutations *lm* and *ml*. Therefore, the sum of words composed of this group is limited and predictable. However, all possible permutations are not actually in use. For instance, the letters ‘*ayn* and *m* are used in the two permutations ‘*am*, (the root of ‘*amm*, uncle), and *ma‘a* (with), while only one permutation of ‘*ayn* and *dh* is used, which is *dh‘* (*dha‘dha‘a*, the movement produced by the wind).²⁰ Moreover, certain combinations are not in use for phonetic reasons. Indeed, some letters cannot be paired with each other: ‘al-Khalil Ibn Ahmad said: the ‘*ayn* and the *h* do not match together in the same word, because of their phonetic closeness, unless a verb is composed of two words as in the combination of *hayya* and ‘*ala*.’²¹

The combination of three *hurūf* offers six possibilities. Thus, for instance, with ‘*ayn*, *q*, and *l* we have ‘*ql*, ‘*lq*, *q‘l*, *ql‘*, *l‘q* and *lq‘* with all six combinations in use.

‘*ql*, *al-‘aq*l is the opposite of ignorance ...; ‘*lq*, *al-‘alaq* is coagulated blood before it dries ...; *q‘l*, *qa‘l* is the root of *al-qu‘al*, that which has been taken away from the flowers of vines and the like ...; *ql‘*, *qala‘a* means to uproot, to extirpate ...; *l‘q*, *al-la‘uq* anything that is licked ...; *lq‘*, *laq‘a* to throw.²²

In this combination virtually all permutations are in use; but this is not always the case. When some permutations are not in use they are said to be *muhmal*, neglected as opposed to those effectively in use.²³

The same rules apply to combinations of four and five letters. A combination of four *hurūf* offers 24 possible permutations or words, and a combination of five offers 120 possibilities.²⁴ However, when a letter is repeated in a word of three letters, like in *qalla* with *qll*, the word is classified in the two *hurūf muda‘af*.²⁵ This principle is said to relate to a certain historical view of the construction of Arabic according to which words were created starting from two radicals to three radicals and so forth.²⁶ Theoretically, the development of Arabic evolved from two *hurūf* to three (with *aṣ-ṣaḥiḥ* composed of three consonants like *qbl*, the *al-*

mu'tall like *wa'ada* or *'āda*, the *al-lafif* like *wa'a* or *'awā*), then to four, and finally to five *hurūf*.

Phonological rules are in fact the central feature of al-Khalil's theory. The alphabet is classified according to the phonetic qualities of the *hurūf*. They are combined (al-Khalil says they match) according to phonetic compatibility ('*ayn* and *h* do not match together, *lā ta'talifu*, neither do '*ayn* and *kh*, nor do *q* and *k*). Furthermore, Arabic has 'phonetic preferences' for certain *hurūf* – for instance, '*ayn* and *q*, the most sonorous and fluid *hurūf*, which, wherever they occur, embellish words and make their sound pleasanter.²⁷ Similarly, the repetition of two *hurūf* in the same word, as in *da'da'a* or *salsala*, is pleasant to the ear and allows phonetic groupings that are usually unpleasant.²⁸ More importantly, words composed of four or five *hurūf* necessarily contain one of the liquid consonants (*d, n, r, f, b, m*). However, in particular cases, two particular *hurūf* may be used instead. But, al-Khalil asserts that any word that does not comply with this rule must be rejected as *muḥdath*, a corrupted innovation, and is not Arabic.²⁹ In fact, one of the aims of al-Khalil's work was to protect Arabic from the corruption (*at-talhīn*) caused by the great mixture of populations brought about by the Islamic conquest and the ill-intentioned *ash-shu'ūbiya*.³⁰

The system al-Khalil developed was replaced through an epistemic break that took place in the second half of the fourth century AH when al-Jawhari (who died in 398 AH) created another organizational principle for the dictionary. The new system, which was adopted in successive dictionaries, as in *Lisān al-'Arab*, is organized on the basis of the alphabet with the last letter of the word as an entry, and the first one as a sub-entry. The new organization of the dictionary ignores the systemic view of language. It neither uses the notion of a combination of letters nor mentions the neglected combinations. With a pragmatic attitude towards the diversity of regional and tribal uses of language, the new system will start a true revolution in the theory of language that will allow all diverse dialects, and particular uses of words and their meaning, to be recorded and find their place in dictionaries. By contrast with the highly theoretical and systematic view of al-

Khalil, the new epistemic approach is indeed open to regional differences and is in harmony with the contemporary flourishing of artistic regional styles.

ARABIC POETICS

It should be known that both poetry and prose work with words, and not with ideas. The ideas are secondary to the (words). The (words) are basic.

Ibn Khaldun³¹

Phonetic rules are essential to achieving an understanding of Arabic poetry and theory of language. When al-Jāḥiẓ asserts that Arabic poetry is untranslatable, he explicitly refers to Arabic phonetics, for he says that when translated, ‘Arabic wisdom’ loses its beauty, which lies not in its meaning but in the music of the language.³² It is precisely this bodily quality of Arabic that al-Khalil emphasizes in both his dictionary and theory of versification.

Al-Khalil is believed to be the inventor of Arabic versification, and author of a work called *Kitāb al-‘Arūd*. This book, supposedly the first Arabic treatise on versification, is now lost, but all later authors refer to it, and even today Arabic metres are called *dawā‘ir al-Khalil* (the circles of al-Khalil). Arab authors define *al-‘arūd* as follows: ‘*arūd* is the science of the rules by means of which one distinguishes correct metres from faulty ones in ancient poetry.’³³ It is believed that in developing this science, al-Khalil was inspired by the hammering rhythms in the copper workshops in the bazaar of his city.³⁴ This is another indication of the importance of the sound and rhythm to his theory of language.

The Andalusian Ibn ‘Abd Rabbih (d. 328 AH/CE 940), whose work is the oldest presentation of the science of *al-arūd*, or versification, and is believed to be the closest to al-Khalil’s treatise, says that the first things that the student of *al-‘arūd* must know are *al-sākin* and *al-mutaḥarrik*, that is the ‘quiescent’ (*al-sākin*); and the ‘moving’ consonant, or a consonant with a vowel (*al-mutaḥarrik*). For, in his view, language in its entirety is composed of these two elements. And in harmony with al-Khalil, he adds that all letters that are written but not actually

pronounced cannot be taken into account in versification, and that all double letters count as two separate letters, the first being quiescent and the second moving.

There are eight segments (or rhythmic feet) that compose the circles of poetry: *fa'ūlun*, and *fā'ilun*, which are composed of five consonants, then *mafā'ilun*, *mustaf'ilun*, *fā'ilātun*, *mutafā'ilatun*, *mutafā'ilun*, *maf'ilātun* all composed of seven consonants. All these parts, or feet, are composed of two basic components – *asbāb* and *awtād*. There are two types of *asbāb* – *al-khafif* and *at-thaqil*; each consists of two consonants. In the former, the second consonant is quiescent while in the latter both consonants are 'moving'. There are equally two *awtād*, each consisting of three consonants – *watīd mafrūq* and *watīd majmū'*. The former differs from the latter by having the middle consonant quiescent (as in *'inda* and *waqta*). The appellations *watīd* and *sabab* are supposedly related through meaning to the actual functioning of the metric feet, thus a *sabab* (tent rope) may not occur in some instances while *watīd* (peg) is a stable component of rhythm that cannot be eluded.

Combined in different orders, the eight rhythmic feet produce a total of 16 possible metres.³⁵ All of them are grouped in a table of five metric circles. The first metric circle, for instance, is composed of three metres – *tawīl*, *basīt* and *madīd* whose hemistichs (Arabic verses are composed of two halves or hemistichs) consist of 24 consonants each. And the fifth circle is composed of two metres, *mutaqārib* and *mutadārik*, whose hemistichs consist of only 20 consonants.

There is a strict formal order in the organization of the five circles. First, their succession goes from longest to shortest. A formal order is then adopted within the circles themselves. The parts of a metre are written around a circle, and,

if one reads the same circle again, but starting at a different point, one automatically gets the mnemonic words of another metre: thus if for instance, in circle 3 one does not begin with *mafā-* (as in *Hazadj* [whose hemistich is *mafā-ī-lun mafā-ī-lun mafā-ī-lun mafā-ī-lun*]), but only in *-ī-* of *mafā-ī-lun*, one

obtains the metric scheme of *Radjaz*, and if one advances still further and does not begin reading till the *-lun*, one obtains the scheme of *Ramal*.³⁶

With graphic symbols introduced in order to have an independent representation of writing, this geometric order was formalized in a hemistich by Gotthold Weil as follows:³⁷

Hazadj |o|o|oo|o|o|oo|o|o|oo
Radjaz |oo|o|o|oo|o|o|oo|o|o|
Ramal |o|oo|o|o|oo|o|o|oo|o|

Here the symbol |o represents the quiescent and the symbol o denotes the moving consonant.

The phonetic nature of the rhythmic feet has yielded another abstract representation in which a *watīd* is represented by the symbol B1, or B2 and a *sabab* by A1 or A2.

In this manner, each of the 8 feet can be reduced to its metric components as follows; thus *mafā-ī-lun*=B1+A1+A1 or *muta-fā-ī-lun*=A2+A1+B1. Each of the 16 metres given in the circle can therefore be scanned on this basis, e.g.

Wāfir = *mufā'alatun mufā'alatun mufā'alatun* =
 B1+A2+A1+B1+A2+A1+B1+A2+A1

or,

Sarī = *mustaf'ilun mustaf'ilun maf'ulātu* =
 A1+A1+B1+A1+A1+B1+A1+A1+B2.³⁸

It is crucial to underline the fact that none of these metres actually appears in its theoretical form given in al-Khalil's five circles, and that al-Khalil was aware of this inconsistency. Rather, the five metric circles are theoretical frames, called *buhūr*, from which poets are supposed to, more or less, deviate in their actual creations, called *awzān al-shi'r*.³⁹

Deviations from the eight basic feet are systematic in pre-Islamic poetry, and the *awzān al-shi'r* derived from the abstract feet amount to produce 37 *furu'* feet. It is therefore clear that the

function of the metric circles of al-Khalil is to provide poets and scholars of Arabic poetry with a theoretical model, and the rules upon which all actual types could be constructed. This approach is, in many respects, similar to contemporary structuralism.

The task of reducing all actual instances to a formal model is made more visible by the construction of the circles and the possibility of connecting one metre with another within a circle, as explained above. This geometric formalism is present also in the 'construction' of Arabic words. In his introduction to *Kitāb al-ʿAyn*, ʿAbd Allah Darwish notes that in order to represent al-Khalil's combinatory system of words with three radicals, Ibn Durayd (CE 837–933), the ʿAbbasid author of the *Kitāb Jamharat al-Lughah*, used a triangle with a letter at each angle. Darwish suggests that a circle similar to the metric circles would be closer to al-Khalil's conception than this triangular representation. There would then be lexicographic circles just as there are metric circles.⁴⁰ The point, however, is not the plausibility of al-Khalil's invention of such circles, but the suggestion that the very same geometric formalism of *al-ʿarūd* (poetic versification) is also present in the conception of the dictionary.

This formalism, and the supremacy attributed to the material/corporeal qualities of language – that is, the musical specificities of the Arabic language – over meaning, seems to have led to the underestimation of the importance of thought. Al-Jāhiz, for instance, argues that poetry and prose were untranslatable due to the musical quality of the Arabic language. The contemporary poet and critic Adonis has challenged the anti-intellectual aesthetic bias of early Arabic poetics:

These beliefs regarding the nature of poetry were what brought about the separation of poetry from thought. Al-Jāhiz goes so far as to assert that poetry is the antithesis of thought because, according to him, eloquence in poetry is that which can be understood without recourse to thought and requires no interpretation.

This separation of poetry from thought reinforced the aesthetics of pre-Islamic orality as against an aesthetics of

writing and confirmed a prejudice of pure bedouinism as opposed to the ignoble ways of the town.⁴¹

Bedouinism was thus identified with purity, spontaneity and naturalness (*badāha*), whereas towns were associated with corruption and artificiality.⁴² This favourable view of bedouinism is also displayed in the very vocabulary of poetics. The word *al-ʿarūd*, or versification, and the vocabulary utilized in its science refer to parts of a tent. *Al-ʿarūd* originally describes ‘the transverse pole or piece of wood which is in the middle of a tent, and which is its main support and hence the middle portion (or foot) of a verse’.⁴³ The words *asbāb* (sg. *sabab*, tent rope) and *awtād* (sg. *watid*, peg) also refer to the construction of tents. The parts of the verse are articulated and literally viewed according to a spatial scheme, specifically that of a tent. It is therefore not surprising that they are organized in circles. Of course al-Khalil, who lived in Basra, was not a Bedouin in the least, and the choice of this vocabulary can be assumed to be deliberate.

On the other hand, the supremacy of the musicality of language led to an aesthetics that requires a parallel between meaning and metres.⁴⁴ Different meanings require different metres, so:

The poet should choose a metre appropriate to the meaning he wishes to express. This in turn led to the belief that there is a definite link between the nature of meanings and the nature of poetic rhythms. Serious or impassioned content requires long metres; subtle, gentle, jesting or dancing content requires short, light metres; and the names of the metres are derived from their characteristics, for example: *al-tawīl*, ‘the long’; *al-khafīf*, ‘the light’.⁴⁵

This conception of poetry and the general theory of language that accompanies it found resonance all over the Arab world. It is significant that our earliest source on *al-ʿarūd*, the work of Ibn ʿAbd Rabbih, is from Andalusia, a country that had broken away from the ʿAbbasid Empire almost two centuries before his *al-ʿIqd al-Farid*

was written, and at a time when it was still ruled by the Abbassids' foes, the Umayyads.

The success and dominance of al-Khalil's theory of language in the early dictionaries, and its effects on poetry, must not lead to a mistaken one-dimensional view. Other views of poetry and language did exist, compete with and contest those of al-Khalil. Notably, some innovative poets, such as Abu Nuwās, ignored the metric circles and their restrictions.⁴⁶ Al-Jāḥiẓ reports that al-Nazzām said of al-Khalil and his *al-ʿarūd*: 'He was fascinated and led astray by his circles [of the *ʿarūd*] which are useless for everybody, except him.'⁴⁷ Al-Nazzām's dismissive statement as reported by al-Jāḥiẓ clearly indicates that far from being universally accepted, al-Khalil's conception of language was the object of debate and controversy. However, it does not follow that al-Khalil's theory did not enjoy widespread popularity and influence. On the contrary, the polemical tone of al-Nazzām's remarks suggests that it was far from unpopular; for what would have been the reason and utility of such an attack if al-Khalil's work had been unpopular? It is well known that philosophical and scientific debates were extremely vivid and rich in the early centuries of Islam. Sometimes, they even degenerated into political conflicts, as in the case with the Mu'tazilite Miḥna (or inquisition) conducted by the 'Abbasid Caliph al-Māmūn (813–33.)

The *Modus Operandi* of Arabic Poetics

Earlier I suggested that the connection between Arabic poetics and the early architecture of the Islamic world should be viewed as a *modus operandi*. How does one define a *modus operandi* common to both Arabic poetics and the architecture of the Islamic world given that nothing similar, for instance to scholastic principles like those of *manifestatio* (the postulate of clarification for clarification's sake in Panofsky's words)⁴⁸ or *concordantia* (acceptance and reconciliation of contradictory possibilities),⁴⁹ which were explicitly formulated in Medieval Europe, seem to have been formulated in Arabic thought? One should not expect to find such definitions as easily available as they are in scholasticism. It is evident, however,

that certain 'mental habits' existed in Muslim Spain, just as in the Muslim Near East, as they did everywhere.

Our conception of poetry is often shaped by a romantic approach that brings inspiration and talent to the fore while obliterating the tremendous effort necessary to any artistic creation. In the Arab tradition, poetic creation was known and discussed as craft: 'For instance', reports Bateson, 'Zuhayr is said to have made a habit of composing for four months, revising his work for four months, soliciting the opinion and advice of other poets for four months, and finally of presenting a single *qaṣīda* in a public performance at the year's end.'⁵⁰

Like all arts, an author's capacity for poetic creation relies on training, a process that necessarily entails the acquisition of 'mental habits'. The story of Abu Nuwās's initiation into poetry is very telling in this respect. Here is how Ibn Manẓur reports it:

When Abu Nuwās asked his teacher Khalaf al-Aḥmar to authorize him to compose his own verses, Khalaf answered: 'I shall not authorize you until you will have learned by heart a thousand old poems.' Abu Nuwās disappeared for some time; then he returned and announced to his master that he had memorized the required number of verses. And in fact he went on reciting them for several days. Then he reiterated his original request. Khalaf hinted to his pupil that he would not authorize him to compose verses until he had completely forgotten all the poems he had just learned. 'This is too hard', said Abu Nuwās, 'I put so much effort in memorizing them.' But the master was firm on his point. And Abu Nuwās had no choice but to retire for a certain time in a monastery, where he occupied himself with everything except poetry. When he felt that he had forgotten all the poems, he returned to his master, who finally authorized him to begin his poetic career.⁵¹

Poetic composition, we are told, requires both learning and authorization by a master. Poetry is surely an art, yet it is also a craft that one learns through formal training and apprenticeship.

This training, says Kilito, is based on a process of memorizing and dismantling memories:

The thousand ancient poems have been displaced, have become like an abandoned encampment that offers only scattered remains to the gaze. Forgetting is a disaster that dismantles, disjoins the blocks, and pulverizes the stone; [note the architectural metaphors] the thousand poems have turned into chaos without name, an amorphous magma with no recognizable form. Poetic creation will be then, a reorganization of the scattered materials – ‘a new *mise en forme*’.⁵²

Ibn Manẓur’s description of Abu Nuwās’s training beckons us to ask a further question unformulated in Kilito’s tumultuous metaphors: what did Abu Nuwās learn through this instruction? Did he really just build and dismantle a poetical memory, or did he in the process gain some ability that Kilito fails to notice? What is essential in memorizing and forgetting? Is it the dismantled remains left in the memory of the student, or the acquisition of a sense of poetic form that will enable him to forge his own poetic forms? It is certainly this ability, this inherent sense of poetic form, that Abu Nuwās’s teacher was trying to instil in him. It is the basic poetic form that the 1000 ancient poems have in common, and that will endure as a trace after the poems are forgotten, that Abu Nuwās was expected to acquire.⁵³ That particular aspect of poetry – namely its musical structure – does not have an autonomous existence. One can feel it in every poem, but one cannot encounter it independently of a particular instance of poetry. It is this element of poetic form that versification attempts to formalize.

The acquisition of the feeling for poetic form by memorizing poems was, indeed, instituted as a basic part of the training of poets. It is the classical *riwāya*, memorization and recitation of old poetry that is required of all apprentices. Bencheikh states:

The requirement of the *riwāya* is not a late phenomenon. ... Ibn Tabataba (d. 322) considers it key in the training

programme of the poet; al-Farabi (d. 339) gives it a decisive role, Abū Hilal al-ʿAskari (d. 335) writes: ‘whoever is not a *rāwīya* [a master of the *riwāya*] of the poetry of the Arabs reveals the weaknesses of his art.’⁵⁴

Bencheikh emphasizes the role of the *riwāya* in the classical training of the poet. He invokes Ibn Khaldun who writes:

It is often said that one of the conditions governing (poetical production) is to forget the memorized material, so that its external literal forms will be wiped out of the memory, since they prevent the real use of (the poetical habit). After the soul has been conditioned by them, and they are forgotten, the method of poetry is engraved upon the (soul), as though it were a loom upon which similar such words can be woven as a matter of course.⁵⁵

Two related notions offer a clearer understanding of the practice of *riwāya* and of its effects: the first is *sariqa*, or theft; and the second is *al-taḍmīn*, or borrowing from old masters.

Sariqa or theft is a well known practice of which most early Arab authors were notoriously accused. Thus, for instance, al-Aṣmaʿi denounces al-Farazdaq for having stolen nine-tenths of his poems.⁵⁶ *Al-taḍmīn*, or borrowing, on the other hand, is a practice that was seen as legitimate. Ibn Qutayba, for example describes authors who were the first to write about a *maʿna*, meaning a theme, and how a particular *maʿna* was reworked by successive poets. Thus Kaʿb ibn Zuhayr was the first to speak of a wolf and a crow, a theme that Dhu al-Rimma and al-Ṭirimmāḥ among others borrowed from him and reworked.⁵⁷ This is also how the celebrated theme of ruins was borrowed and creatively employed by many other poets. Far from theft, the borrowing of themes and tropes is desirable – potentially perceived as a form of competition and a tool to improve one’s repertory of poetry, even if some poets may be considered unsurpassable in certain *maʿānī*, or discursive tropes.

The term *al-taḍmīn* seems to have been introduced not long before the eleventh century CE. However, the practice of borrow-

ing was referred to long before that. For example, Ibn Qutayba writes about borrowing, and uses the term *akhada*, which means to borrow. Yet plagiarism and theft, as the remarks of al-Aṣma'i indicate, were consistently denounced. The difficulty, of course, lay in determining the line of demarcation between borrowing and theft.

Furthermore, it is possible that the notion of borrowing and producing new (and possibly better) poems on old tropes could be considered a logical consequence of the apprenticeship of poetry. Poetic craftsmanship, as I indicated above, relies on the practice of *al-riyāwa*, or memorization of the works of old masters. The reworking of old tropes is simultaneously a homage to the master poets and a challenge. It is an exercise that suggests the poet's veneration of the old masters. Yet a novel creation that draws upon an old trope can also be viewed as a threat, potentially exposing a weakness of the original. Thus, for instance, we are told that Zuhayr composed a poem about 'Rights and law' on which he has never been challenged.⁵⁸

The notions of *al-riwāya* and *al-taḍmīn* seem therefore to undergird the practice of poetic creation. They also indicate that poetic creation, as a process of invention and production of new meanings and forms, is viewed as 'work' on inherited forms of the past. However, the contempt for *sariqa*, theft, indicates that innovation is required. It is this double exigency of an unavoidable reference to the past, and a necessary search for new forms and meanings that ensures novelty without provoking unacceptable fractures between poet and public, or poet and society. The latter as an audience represented by the powerful and the critics (theologians and jurists like Ibn Qutayba) seem to seek the new, but at the same time fear the unknown and the subversive as indicated, for instance, by the ambivalent attitude toward Abu Nuwās's lascivious poetry about young boys.

When al-Nazzām criticizes al-Khalil, and sarcastically remarks that metric circles are useless to poets, he is not suggesting that al-Khalil is wrong. He more likely means that knowledge of *al-ʿarud* is not necessary to writing poetry, and that versification and metric circles can help one grasp the musical quality of poetry, but do not, in themselves, enable one to write poetry.

A sense of poetic form could be defined as the mental ability to place and tie words together musically – or to write poetry. This ability can be acquired, we are told, only by memorizing and forgetting. In other words, a sense of poetic form is a mental habit that can be acquired through adequate training.⁵⁹ That the sense of poetic form was viewed as a skill that can be developed is clear from the account about Abu Nuwās. But what is more remarkable is that the sense of poetic form was also conceived as a basis for competition, as seen in the highly esteemed poetic duels.

Abu Nuwās seems to have been a champion of poetic competition. He is reputed to have been a great master of palindromes, verses that are the same when read backward or forward. He also excelled in poetic farce: once he wrote a poem on the wall of Harun al-Rashid's palace that was critical of Zubayda, the caliph's wife; but when summoned the next day to the palace, on his way to the audience with the caliph, he discreetly deleted a diacritical point from the poem, changing it into eulogy. These poetic games indicate highly sophisticated poetic and linguistic skills, and show an acute awareness of the formal qualities of poetry. The greater a poet's mastery of these formal games, the more he was esteemed and respected.

The formalism of these poetic games connects the most subversive poet of the time, Abu Nuwās, with mainstream thought, as represented by al-Khalil or al-Jāhīz. However *Shu'ūbi* (anti-Arab and pro-Persian) and innovative he may have been, Abu Nuwās remained attached to poetic formalism, in which he seems to have surpassed all his contemporaries. Indeed, the use of the same *modus operandi* does not exclude the existence of differences and oppositions in notional contents. This is precisely why Panofsky says that in studying intellectual connections, such as those pertaining to architecture and poetry, the 'notional content' should be disregarded, and only 'mental processes' should be taken into consideration.

Having defined more precisely what a *modus operandi* is and how I intend to use it in my discussion of architecture, I shall now summarize al-Khalil's description of the *modus operandi* implied by Arabic poetics. Like al-Jāhīz, he asserts that the defining feature of

Arabic is its musicality – the beauty of its sounds and their structure. Arabic poetics, as developed in *al-ʿarūd*, versification also emphasizes this musicality. A few principles are at work in the poetic creation.

First principle: language is based upon two mechanisms – *at-taqṭī* and *at-tarjī*, division and recurrence (or repetition.) Words are created by way of combination and permutation, which logically presupposes *at-taqṭī*, or division.

Second principle: all words are predictable and this is deducible, by calculation, from the principle of combination of the *ḥurūf*. A systematic inventory is possible – the dictionary.⁶⁰

Third principle: there exists an aesthetic of language, and this dictates that some combinations of *ḥurūf* are unacceptable and rejected; they are called *muhmal*.

Fourth principle: the aesthetics of language also dictate the principle of poetic order. There is a musical order of language in which the poetic resides. Poetry is created in conformity with a definite number of metres through recourse to the mechanism of *at-tarjī*, repetition. It should be recalled that in addition to metres, the rules of rhyme ensure a strict formal order: ‘If Arabic metres impose relatively little strain on the normal patterns of speech, Bateson writes, ‘the rules of rhyme, /*Qāfiya*/, serve to supply further complication. Every line in the poem must end with the same rhyme, as well as the end of the first hemistich of the first line.’⁶¹

Fifth principle: the principle of circularity and infinity. As metric circles, Arabic poetic metres imply a circular recurrence of the syllables, at least in their abstract expression in the metres. This circular recurrence is, in principle, open to infinite repetition. This is prevented only because of the form of the *qaṣīda*, a name given to poems of a limited length.⁶² According to Ibn Qutayba, one of the first Arabic authors to write about the *qaṣīda*, an Arabic ode is composed of four parts:

- A prologue (*dhikr*), in which the poet mourns the beloved, describes the ruins of her camping place, and portrays her charms;
- a *nasīb*, in which the poet bemoans the violence of his love and

sufferings. The *nasīb* is intended to seduce the listener, and gain his or her sympathy. This task is always possible to achieve for, 'God made men sensitive to love poetry (*al-ghazal*) and to the company of women.'⁶³

- When the poet ascertains the attention and sympathy of the listener, he begins to describe his journey (*raḥīl*) to the person to whom the poem is addressed, and makes requests for gifts and favours; and
- once the poet feels that his requests have been heard, he begins the *madīḥ* eulogy of the protector or patron.⁶⁴

The construction of the *qaṣīda* is based on an understanding of the effect of poetry on the listener. It trifles with his feelings, and the two parts, the *dhikr* and the *nasīb*, solicit his love and sympathy. The requests made by the poet are not mentioned before the sympathy of the listener is gained. And the eulogy is only begun once the favours are potentially secured. This structure thus appears to aim towards a precise goal from beginning to end.

However, up until the third century AH (ninth century CE) the four parts of the *qaṣīda* were seldom connected semantically; the transitions from one part to another do not seem to derive logically from the point of view of the meaning.⁶⁵ Moreover, because in its conception the *qaṣīda* is inseparable from its recitation, each verse must be an independent unit. This is why the progression within the *qaṣīda* sometimes lacks a semantic basis.⁶⁶ The unity of the verse is guaranteed by the prohibition of enjambment – or the breaking of a syntactic unit between two verses – such that each verse must be a grammatically complete sentence.⁶⁷ Still, the *qaṣīda* is to be understood as a whole, and Ibn Qutayba asserts that, 'Later poets should not deviate from the doctrine of the old poets regarding these parts [of the *qaṣīda*].'⁶⁸ The form of the *qaṣīda* is thus definitively outlined, and the poet must submit his or her work to its doctrine and parts. But, the poet has freedom to decide on the equilibrium between its parts.

On the basis of the metric circles, a poem has no definite length, and can thus be expanded indefinitely. It is, however, limited by the form of the *qaṣīda*, and its different parts. Still, no

specific length is defined, and it is the poet who chooses both its length and the equilibrium between its parts.

The formal order of Arabic metres presupposes that words are not perceived as singular components of language but as parts of a continuum conceived in musical terms. Poets can write only within a formal order in which the relations of continuity between words are given primacy over the words themselves. Moreover, as a musical continuum, metres themselves are imbued with meaning, and poets are said and required to choose the metre that best suits the semantic content they aim to express. There is thus an isomorphic parallel between form and meaning; in other words, specific metres have specific meanings. The poetic resides in the materiality of the metres. This leads to the primacy of form over thought, or to the abstraction of meaning. The expression of the metres in the eight metres outlined above (*fā'ilun*) is the best illustration of this fact. This is also why, in al-Jāhīz's words, it is not the meaning but the *ṣawt*, the voice or sound, that moves the soul and stimulates the body.

Decoration and Poetics

The true paradise of Islam is not made of *houris* [celestial virgins] but of sacred arabesques.

(André Malraux)⁶⁹

There is no doubt that decoration is of central importance in the architecture of the Islamic world. The worldwide usage of the word 'arabesque' testifies to its excellence and importance, at least to the mind of Western scholars. Moreover, some scholars consider decoration to be the dominant aspect of the architecture of the Islamic world. For example, Alexandre Papadopoulos believes that, 'In Muslim opinion, architecture was an art only by reason of its surfaces, its skin of mosaic, stucco, ceramic, or marble, the verses of the Koran to be read on its walls, and the fascination of its abstract decoration of arabesques.'⁷⁰ A more interesting view is that which Oleg Grabar elaborates on the basis of the notion of ornament in the conclusion to his *Formation of Islamic Art*. He draws a line of distinction between decoration and ornament upon

remarking that in the architecture of the Islamic world, motifs 'do not seem to have an intellectual or cultural content, and their function is simply that of beautification, of endowing the monument on which they are found with visual pleasure'.⁷¹

Grabar calls this kind of theme ornamental and contrasts it with classical decorative ones, for which meaning is intentional. Furthermore, this ornamental characteristic of early art of the Islamic world is in fact intertwined with another value:

that of ambiguity and ambivalence, whereby a given feature lends itself to two simultaneous and partly contradictory interpretations, a precisely iconographic one and an ornamental one. Such is the case in some of Khirbat al-Mafjar's sculptures as well as on Spanish ivories. The question is whether this conclusion results from the original creator's will or from insufficiently developed criteria of interpretation. If the first, we encounter a very modern type of artistic creativity in which the *primary burden of interpreting* would be a remarkably contemporary aesthetic procedure, and an explanation ought to be provided.⁷²

This condition of ornament, with its ambiguity and ambivalence of meaning, is what I call a poetic approach to decoration. Paul Valéry describes the prolonged hesitation between form and meaning as poetic.

I must also mention that Oleg Grabar remains sceptical about his own view of ornament. He writes:

By stating that the Muslim world, for whatever reasons, diverted its energies into ornament, we are actually making a highly debatable assumption that the dichotomy between the iconographically meaningful and the ornamental reflects two entirely independent artistic purposes and visual experiences. In reality, we must ask whether some meaning cannot be given to those forms of early Islamic art that appear ornamental only in contrast to the art of other traditions. Alternately, we may have to conclude that the

Muslim world simply rejected visual forms as major expressions of its culture, or that it discovered some totally new ways of contemplating and then making works of art.⁷³

Al-Jāhīz says that in pre-Islamic times architecture was for the Persians what poetry was for the Arabs, and in the Islamic period the latter borrowed architecture and its symbolic use from the former. This is a clear indication that poetry and architecture have the same social function. Furthermore, in the Islamic world decoration exhibits the very evocative play of hiding and displaying meaning that characterizes poetics, which is another indication of the existence of a structural connection between architecture and poetry. On this basis we can venture to suppose that there is no intention to hide some esoteric meaning of decoration.

Therefore, the function of ornament cannot be limited to inducing pleasure, but should be viewed, to borrow an expression from Gaston Bachelard, as an ‘invitation to daydream’.⁷⁴ A poem by Pierre Albert-Birot about a drawing is a wonderful illustration of Bachelard’s point.

And here I am turned into the design of an ornament
 Sentimental scrolls
 Coiling spirals
 An organized surface in black and white
 And yet I just heard myself breathe
 Is it really a design
 Is it really I.⁷⁵

Commenting on this poem, Bachelard writes: ‘The drawing is more effective for what it encloses than for what it exfoliates. The poet feels this when he goes to live in the loop of a scroll to seek warmth and the quiet life in the arms of a curve.’⁷⁶ In the arms of a scroll the beholder finds warmth, and an evocative universe where the imagination freely builds and undoes narratives and scenes. It is in this sense, I suggest, that the poetic nature of ornament should be understood.

Variety, the Antidote of Boredom

Al-Jāhiz asserts that in literature, stylistic variation is the only prevention against boredom. Variety allows the mind to move from one motif to another, and in so doing, retains the attention of the reader. Such mental agility enables the mind to make unforeseen connections. In so doing, it stimulates dreamy perception (reverie), and makes possible the free creation of meaning.

Variety is also a basic principle of poetry. Ibn Khaldun writes:

Poetry in the Arabic language is remarkable in its manner and powerful in its way. It is speech that is divided into cola having the same metre and held together by the last letter of each colon. Each of those cola is called a 'verse'. The last letter, which all the verses of a poem have in common, is called the 'rhyme letter'. The whole complex is called a 'poem' (*qaṣīda* or *kalimah*). Each verse, with its combinations of words, is by itself a meaningful unit. In a way, it is a statement by itself, and independent of what precedes and what follows. By itself it makes perfect sense, either as a laudatory or an erotic (statement), or as an elegy. It is the intention of the poet to give each verse an independent meaning. Then, in the next verse, he starts anew, in the same way, with some other (matter). He changes over from one (poetical) type to another, and from one topic to another, by preparing the first topic and the ideas expressing it in such a way that it becomes related to the next topic. Sharp contrasts are kept out of the poem. The poet thus continuously changes over from the erotic to the laudatory (verses).⁷⁷

This description of continuing changes of topic within the same *qaṣīda* is fully consistent with al-Jāhiz's argument regarding the thematic and stylistic variety used in the composition of the book, a fact pointing to the wide diffusion of this principle.

One could question the influence of al-Jāhiz's thought by suggesting that Ibn Khaldun's work dates to the fourteenth century CE, whereas al-Jāhiz lived 500 years earlier, writing in the

ninth century CE. One might accordingly conjecture that being from different historical periods, the two authors should be considered as participating in different epistemic formations. Yet, there is evidence that, despite the historical gap, Ibn Khaldun's ideas about variety in the thematic content of poetry merely reiterated in very clear terms a classical view shared by al-Jāhīz. Indeed, Ibn Qutayba (d. 276 AH/CE 889) argues that 'contrived poetry' is recognizable because its succeeding verses do not match, and are not related in any way. He also writes:

Once 'Umar ibn Laja'i said to another poet: 'I am a better poet than you.' The other asked: 'What makes your poetry better than mine?' And 'Umar answered: 'It is because I say a verse and go on with its "brother" and you say a verse and go on with its "cousin"'.⁷⁸

Ibn Qutayba's account shows that verses were already written as independent elements as early as the classical Islamic period. Moreover, it expresses the view that 'brother verses', that is, closely semantically related verses, make better poetry than more distantly related ones, for the autonomous quality of the verses does not preclude the need for a unity of the articulated ensemble.⁷⁹ This unity expresses the fact that the *qaṣīda* is conceived of as a movement in which every single verse, though written independently, takes a thematically coordinated place in an overall order. At the outset of the act of writing, the poet conceives of a particular aim.⁸⁰ To summarize, the *qaṣīda* is composed of verses that stand as independent units, but are organized and articulated together by 'tying verses' so as to produce a perceptible and meaningful movement. Excellent poetry can accordingly be distinguished by its orderly movement and the 'kinship' of verses, or the fluid transitions from one verse to another.

The principles of design of decoration in the Islamic world are strikingly similar to those organizing the *qaṣīda*. It is widely recognized that variety of motifs is an important characteristic of that decoration. Building in part on Herzfeld's work on Samarra,⁸¹ Oleg Grabar distinguished three groups of motifs. The first and largest is



1. Panel with stylized bird. Ninth-tenth century CE pinewood 0.73m x 0.32m (Paris, Louvre Museum).

composed of vegetal elements, which are mostly of Sasanian origin. The second group consists of geometrical elements, often characterized by a tension between a complete and a broken unit. Artistic refinement consisted in avoiding explicitly visible and definable units. One can reasonably characterize the ninth-tenth century wooden panel from Egypt where the perception of a bird disappears when one tries to see its parts as an exquisite artistic achievement of this design principle (figure 1). Grabar described the third group of motifs as a ‘miscellaneous category’, which, in his view, must be better defined or incorporated into the other two groups.

This classification has been refined in recent scholarship, which has nuanced Grabar’s provisional three categories. In *Islamic Ornament*, Eva Baer draws upon Grabar’s findings, but refines his classification by identifying four groups of motifs. The first is composed of vegetal motifs, the second of figural ones, the third of geometric ones, and the fourth of epigraphy, or inscriptions. In contrast to Grabar’s study, however, Baer’s analysis is not limited to the early art of the Islamic world; and her attention to later periods affects her findings. Besides, Eva Baer is not interested in the formation of ornament as such, but in its maturation – in the transitions from its earliest developments to its later manifestations. In her own words, her work tries ‘to delineate the major changes which Islamic ornament underwent over a period of about 1000 years’.⁸²

Baer's work, like most recent scholarship, does not discard the leading views about decoration in the Islamic world. It, too, acknowledges the importance of variety to that decoration. This variety is first found at the level of motifs, and then can be analysed on the basis of techniques. Indeed, in the Islamic world decoration uses numerous techniques – mosaics, ceramics, stuccoes, stone, marble, woodwork, metalwork and glass. It is remarkable that, at the outset, that decoration tended to abstract motifs from specific materials. Early transfers from one medium to another are noticeable: designs of rugs are transferred to mosaics in Khirbat al-Mafjar. The designs of stuccoes from Samarra are presumably transfers from woodwork (plate 7).⁸³

Variety was overwhelming in Umayyad decoration, and less so in 'Abbasid works. This difference can be explained by the refinement of the process of selection of motifs in the 'Abbasid period. Still, variety remains a pertinent characteristic throughout the early centuries of Islam (plates 7–11).

The principle of variety represents a marked similarity between architectural decoration and literature. Previously, I noted that in al-Jāhiz's view, the effects of the song are similar to those of decoration, and the function of poetry is similar to that of architecture. We can then assume that the function of variety is similar in writing (poetry and the book) and decoration. Variety of motifs and techniques in decoration can be understood as a means for allowing the mind to contemplate, and move fluidly from one motif to another, one material to the next, and one architectural element to another with pleasure, thus avoiding any risk of boredom, which is a consequence of repetition and sameness.

Music of Language and Ornament

It has been noted that, despite its new approach and innovation of the arabesque, in the early Islamic period decoration had for centuries continued to be influenced by earlier regional forms of design. Earlier forms were re-employed and imitated without being influenced by the arabesque (mosaics at Qasr al-Ḥayr East, and the woodwork of the Aqsa Mosque in Jerusalem). The reuse of materials looted from antique ruins – in particular columns and

capitals – also amounted to the continuation of earlier forms of decoration. Moreover, the imitation of antique capitals was a common practice. Regional characteristics thus retained an important role, and ultimately contributed to the creation of distinct regional styles. According to Oleg Grabar, this tension between local tendencies and a pan-Islamic idea led, through modification of the appearance of works of art, to the creation of a new syntactic structure of architectural decoration. This newly emerged visual syntax preceded the creation of a new morphemic structure.⁸⁴

Some specific rules typify this syntax of design that was characteristic of decoration in the early Islamic period. In addition to the acknowledged significance of varying motifs, which is the most prominent feature, decoration is further characterized by a few principles of design to which, according to the linguistic model, all the visible units of design (or motifs) are subordinated.

The first is the principle known in visual art as horror vacui, or the fear of empty spaces. According to this principle, which is the most widespread cliché about the art of the Islamic world, all objects or walls must be entirely covered with decoration. Like the walls of the mosque at Damascus, those of the Dome of the Rock were completely covered with decoration, mosaics and marble panelling (plates 1–2). In contrast to the classical Roman opposition between a background, and the ornament that stands against it, the principle of *horror vacui* is described as a tendency to eliminate the background. The complete elimination of the background was first achieved in the stuccoes of Samarra (plate 7). It was also said that the classical Roman opposition between background and ornament was replaced in the art and architecture of Islam by a contrast between light and shade. It should, however, be recalled that the contrast between light and shade was not ignored in antiquity, and that the designs of friezes and entablature were also based on the play between the two.

In epigraphy, the letters are often inscribed against a simple, smooth background, as in a Spanish-Umayyad ivory basket.⁸⁵ One can observe the same treatment with vegetal motifs in the mosaics

of the Umayyad Bayt al-Māl Mosque in Damascus (plates 2–3). Moreover, in ninth-century buildings, as in the Ibn Tulun mosque in Cairo, one witnesses a tendency to place decoration selectively so that it highlights the structure of the building, thus seeming to break away from the principle of *horror vacui* (plate 13).

A psycho-sociological interpretation of this principle is that of the manifestation of a *nouveau riche* mindset, or a profound gratitude through sumptuous expenditure on religious buildings. It is also likely that such a complete use of space might have merely been an expression of lavishness denoting power and wealth.⁸⁶

Whatever our preferred interpretations might be, the principle of *horror vacui* seems to predominate in non-narrative-based decoration but is absent from figural (narrative-based) representations. The mosaics of the Dome of the Rock and the mosque at Damascus, and the tree with animal scenes in the floor mosaics in the audience chamber of the bathhouse of Khirbat al-Mafjar, do not display the same tendency for the sumptuous occupation of space; neither do the paintings from Samarra (plates 8–11) or later book illustrations such as the *Kitāb fī Maʿrifat al-Ḥiyal al-Handasiya* of al-Jazari, CE 1315 (plate 18), the *Kitāb al-Bayṭara* CE 1210 (plate 17), or the *Maqāmāt al-Ḥarīrī* CE 1237 (plate 16). In all these examples, a background is clearly differentiated from a more elaborate thematic foreground.

This last remark suggests that the so-called principle of *horror vacui* is incompatible with the notion of representation as mimesis of reality, for classically a background conceived of as a stage is necessary for the representation of space. By contrast, when the artist does not seek to represent space, the background becomes unnecessary, perhaps even incongruous. Indeed, in this situation the notion of a background is meaningless if not misleading. The same uselessness of a background is shown in modern abstract painting, as in the works of artists like Mondrian or Malevich.

The second principle is the primacy afforded to the relations of continuity between words over the words themselves, and the preference of the expression of relations between motifs over the motifs themselves. The second syntactic rule of decoration may be formulated as the

preference given to the expression of relations between elements over the elements themselves. This rule is consistent with the impact of geometry in decoration, particularly its function as a grid into which different motifs are interwoven, as in the marble window grille in the mosque at Damascus (figures 2a–2b).⁸⁷ The best illustration of this principle is found in Samarra. In the Samarra style, it is hardly possible to describe the motifs individually (plate 7). The best description of these designs is expressed in terms of the relationships between shapes. That is why in *The Mediation of Ornament*, Grabar describes this approach as particularly modern, and similar to that of Escher's. A piece of Egyptian woodwork described by Grabar displays the same approach (figure 1). This woodwork, depicting a bird by contrasting shapes and lines, achieves a high level of abstraction.

This principle, according to which priority is given to the expression of relations between elements over the elements themselves, bears a striking resemblance to that of the primacy afforded to the relations of continuity between words over the words themselves, a characteristic central to Arabic poetics. The abstraction of the poetic form developed by the musical nature of language expressed in the metric parts (such as *fā'ilun*) is thus comparable to the abstraction underlying visual composition. I thus suggest that we can think of the geometric structures underlying these visual compositions as the 'metres' of architectural decoration.⁸⁸

The third principle is the principle of the potentially infinite number of verses in a poem and the rule of the potentially infinite expansion of the compositions in decoration. The third syntactic rule of decoration relates to the use of geometry and geometric patterns, which witnessed an extraordinary development beginning in the early period. Design compositions are constructed with different axes of symmetry. Rarely finite or represented by physical entities, these axes are only imaginary effects of the compositions. But they are necessary to rendering the designs intelligible to the viewer (plate 7). Often, there is more than one axis of symmetry. Grabar has accordingly spoken of the ways in which the viewer can choose his point of view, and move freely from one



2a. Marble window grille, Great Mosque at Damascus.

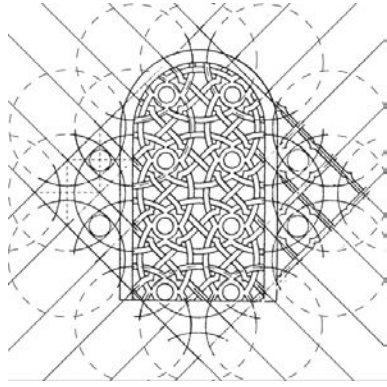

2b. Geometric analysis of window grille.

part to another. It is worth noting that the books by al-Jāhiz can be read in the same way. There is no need to start at the beginning; one can move and make leaps backward and forward from one part to another.

A related rule of architectural syntax, as Grabar outlined, is the possibility of infinite growth stemming from the geometric character of motifs. As this rule is a derivative of the previous one, it should not be counted separately. Since the axes of symmetry are not concretely represented by particular motifs, the design can be extended at will in any direction, as in the Samarra stuccoes (plate 7).

It is the decorator who, within the boundaries of the surface to decorate, chooses the limits of the design. The equivalent to this capacity for infinite artistic extensions in poetry is the potentially limitless expansion of the poem. In decoration the combination of motifs is open to unlimited expansion, only limited by the arbitrary form of a frame. Like the poet who selects the number of verses of his poem based on the form of the *qaṣīda*, the decorator defines the limits of a design by choosing a frame. The arbitrary relation between the parts of the *qaṣīda* (*dhikr*, *nasīb*, *raḥīl*, and *madiḥ*) is similar to that existing between a design and its frame.

The fourth is the principle of aesthetic selection of language that

dictates the use or rejection (muhmal) of certain combinations of ḥuruf, and of motifs in decoration. Grabar defines the forth syntactic rule of decoration as the possibility of incorporating motifs of all origins. Yet, incorporation also entails selection. The basic motifs Muslim decorators used came from earlier visual cultures, principally Byzantine, Coptic and Sasanian. Their assimilation was based on a new and specific approach, which, as Eva Baer argues, involved ‘a selective adoption of motifs and designs, in the process of which subsidiary ornaments were “upgraded” to become the main decorative theme’.⁸⁹ The acanthus scroll, garlands and vegetal motifs, which were subsidiary motifs in late antique decoration (in Hagia Sophia, for instance) became primary motifs in the decoration of the interior of the Dome of the Rock.

This selective adoption presupposes the decomposition of the language of the inherited visual cultures into basic motifs or morphemes, the smallest linguistic unit, followed by a critical examination of the aesthetic qualities of each morpheme. The adopted motifs (or morphemes) can then be used as such in complex designs or, when needed, combined into elements of a higher semantic level (like the new combinations of motifs of the Dome of the Rock). This approach to decoration and selection of motifs is comparable to the linguistic approach outlined by al-Khalil. He, too, deconstructs the Arabic language into its smallest units (*ḥuruf*), and then defines the combinations of units that are acceptable, differentiating them from those he instead rejects as foreign to Arabic and aesthetically unacceptable.

It is important to consider this principle of selective adoption in its historical context, and consider it in connection with the movement *ash-shu‘ūbiya* – the Persian claim to superior culture – and the Arab reaction to it. It is further relevant to reflect on the relation between the impact of this movement and the arts, and to consider the common interpretation that the rejection of the major motifs of the arts and the ‘upgrading’ of the subsidiary ones marked a reaction against the *ash-shu‘ūbiya* and an attempt to ‘Arabicize’ the vocabulary of the inherited visual arts. The fact that ninth-century architectural decoration in Iraq seems to show less variety than that of the Umayyads of Syria may be interpreted as a

sign of the exacerbation of the struggle, for Iraq was then the main centre of Arab culture and related ideological debates. It should equally be recalled that the great Umayyad architectural programmes were contemporary to the introduction of Arabic as the official language, and to Arabic coinage. This means that, at the very least, a political willingness existed, if not the explicit guidelines of a loose political programme of Arabization.⁹⁰

The theories of selective adoption assume that the appropriated motifs are considered Arab, and that the rejected ones cannot be viewed as such. There is nothing odd about such an attitude, for, like the Arabic language, which shares many *hurūf* with other languages while having the exclusive use of particular *hurūf*, decoration can share a large number of its motifs with other arts while retaining the exclusive use of certain motifs. Arabic-based epigraphy had a particularly important role in introducing distinctly Arab motifs. Early Islamic coins, in which a Sasanian model was adapted by the simple addition of an Arabic inscription, are a good illustration of this function of epigraphy.⁹¹

On the linguistic level the adoption of foreign words is often sanctioned by slight phonetic changes, as in the case of the Persian *handaza*, which Arabs appropriated to become *handasa* with the replacement of the z by an s.⁹² The nature of Arabic phonetics justifies these changes. In the same way, to acquire the desired 'look' the adopted decorative motifs are submitted to stylistic alterations. The most common of these alterations is the transformation of vegetal motifs into a more abstract form, as in the Samarra stuccoes (plate 7). This appropriated form of abstraction was taken to an extreme in the ninth century as revealed by the fact that 'vegetal ornament had no reality and physicality for the 'Abbasid beveller.'⁹³

In Panofsky's terms we can assume that the principle of selective adoption of decorative motifs, like the formation of Arabic words as institutionalized by linguists (the selective combination of *huruf*), represents the application of a general 'mental habit'. It can also be interpreted as a manifestation of the Arab reaction against the claims and the protestations of the non Arab populations of the Islamic empire.

The fifth principle is *al-taqṭī* or the principle of successive divisions in poetics and in architectural composition. In Arabic poetics *al-ṣawṭ*, the voice/sound, is a material entity. It is a material object that penetrates the body and circulates in it. It can move the soul, perplex the mind, and even kill the body it penetrates (*al-Jāhiz*). Because of its material qualities, *al-ṣawṭ* shapes language as a musical continuum, and enacts the poetic principles of *al-taqṭī* – the successive divisions of the verse into metric parts – and *al-tarjī* – the regular recurrence of these parts. Thus, a verse is first divided into metric feet – there are eight feet – then subdivided into smaller parts (*awṭād* and *asbāb*), which in turn can be divided into *ḥurūf*. These successive divisions make possible the regular recurrence of a musical rhythm in poetry.

Describing the Umayyad palace at Minya, Creswell writes:

Now it must be expressly noted that in the planning of this rectangle a system has been adopted which we shall meet with again at Mshatta in its fully developed form, viz.: *the successive, symmetrical subdivision into three*. Here the first subdivision into three gives us the main hall and its two flanking rectangles; by the second subdivision we get the basilical hall and, to the west of it, the large room flanked by a pair of smaller ones to north and south. At Mshatta this system is carried much farther [figure 3].⁹⁴

This principle of successive subdivisions can be observed in other buildings, like the reception hall of the 'Amman palatial complex, and in a less rigorous way in the two square parts of Qasr at-Tuba (figures 4a and 4b). The palace of Mshatta displays the strictest application of *successive, symmetrical subdivision into three*. Perhaps we should also consider the nine bay mosque type as another application of the same principle, with two successive subdivisions of a square into three parts (figures 5a and 5b).

This successive subdivision has been considered an unusual planning method. It has been viewed as proof of the arbitrariness and geometricism of the architecture of the Islamic world. But, what if instead we were to analyse this trend of successive

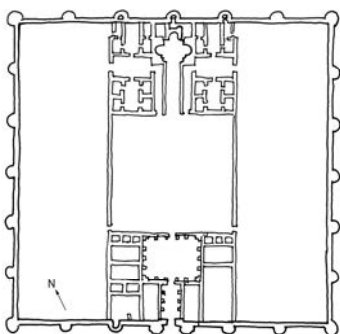

3a. Mshatta palace plan.

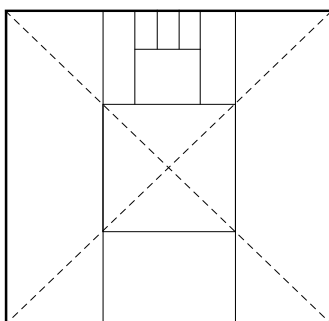

3b. Mshatta palace diagram of successive subdivision.

subdivisions through the lens of our knowledge of Arabic poetics? My argument is that successive, symmetrical subdivisions are poetic *al-taqṭī* applied to architectural planning. Small deviations of the actual plans of the buildings from perfect geometric schemes can be compared with the alteration of metres that occur in poetry. Like the *ziḥāfāt* and the *ʿilal* that allow the poets to deviate from the theoretically perfect poetic metres and compose their verses in accordance with the *awzān al-shiʿr*, architects use architectural deviations from perfect geometric schemes in their actual planning methods. That is why, just as most poetry deviates from the metres, most buildings deviate from perfect geometry.

It might be argued that a historical gap exists between the building of the Umayyad palaces, which occurred in the first half of the eighth century, and the creation of Arabic versification by al-Khalil in the second half of that century. However, on closer examination, this principle does not stand as the formalization of a poetic principle cannot be identified with the emergence of the principle itself, for the principle certainly predates its formalization. Rather, it is the basic poetic habit, the *modus operandi* that is significant. What is at stake is not the transference of a rule from one domain to another (as supposed by the structural approach suggested by Oleg Grabar), but the involuntary application of the same mental habits in diverse realms. Since Panofsky first

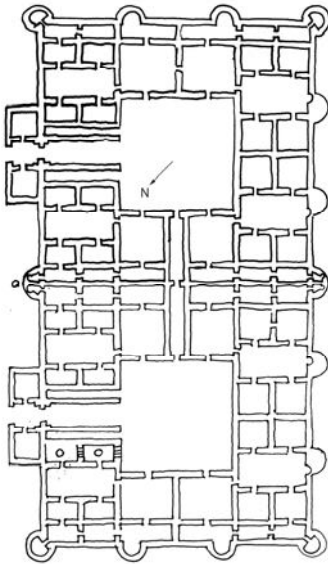

4a. Qasr at-Tuba plan.

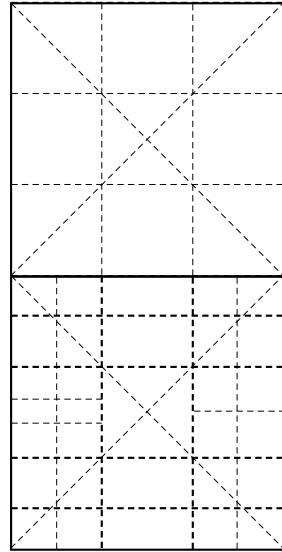

4b. Qasr at-Tuba diagram.

introduced the notion of mental habits in his *Gothic Architecture and Scholasticism*, scholars have expanded the debate.

The study of mass media has revealed the acquisition and dissemination of new mental habits. Recent research about computers, studying the internet, and email suggests that new mental habits are emerging as a consequence of the use of these new technologies, whereas other mental habits, like mental arithmetic, are being lost because of the use of pocket calculators.

In the early Islamic period, poetry was a popular art form, and its social diffusion and authorship was not limited to the elite. Early theorists of Arabic poetics argue that the purest poetry was found among the Bedouins. Furthermore, poetry was sung, and therefore poetics was surely far more widely diffused than it might appear to a public accustomed to encountering poetry primarily in books and academic classrooms. Poetic games involving improvisation and song were ordinary events.⁹⁵ As Bateson writes: 'improvisation of poetry, especially in the simpler metres as /rajaz/, was common and the improvised poems were usually forgotten.'⁹⁶

It is no wonder, then, that the designers of the royal buildings,

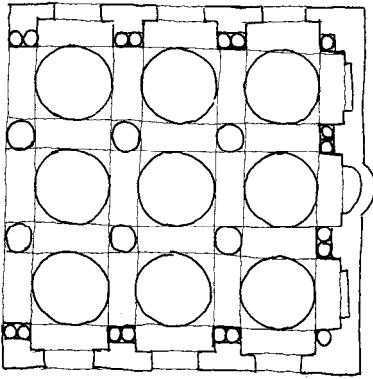

5a. Balkh, Nine Bay Mosque plan.

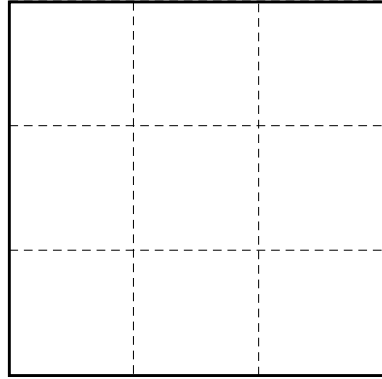

5b. Balkh, Nine Bay Mosque diagram.

who were often astrologers and learned men, were also acquainted with the poetic form. Like the architects of the Gothic cathedrals who did not need to be scholastic philosophers to be imbued with scholastic reasoning and exemplify this in their designs, the ‘authors’ of the architectural spaces of the Islamic world did not need to be poets to be influenced by poetic sensibilities.⁹⁷ As important and learned men, architectural planners were regularly in contact with poets and poetry. They were also probably aware of the craft of poetry, and were sensitive to poetic form.

Thus a structural connection between architecture and poetry seems more than plausible. It should also be noted that this method of planning seems to have been equally used in ‘Abbasid architecture (figure 6). Hillenbrand has noted that:

The parallel [of the palace of Ukhaidir] to Mshatta, with its central tract cut off from the side tracts where most of the living quarters were probably sited, is striking. That parallel extends still further, and may be seen at its closest in the section immediately within the entrance. A vestibule with the first surviving fluted dome in Iraq gives way to a great vaulted hall with laterally placed arched recesses. This replaces the more humble courtyard at Mshatta, but it is flanked by similar rooms and probably this unit had the same

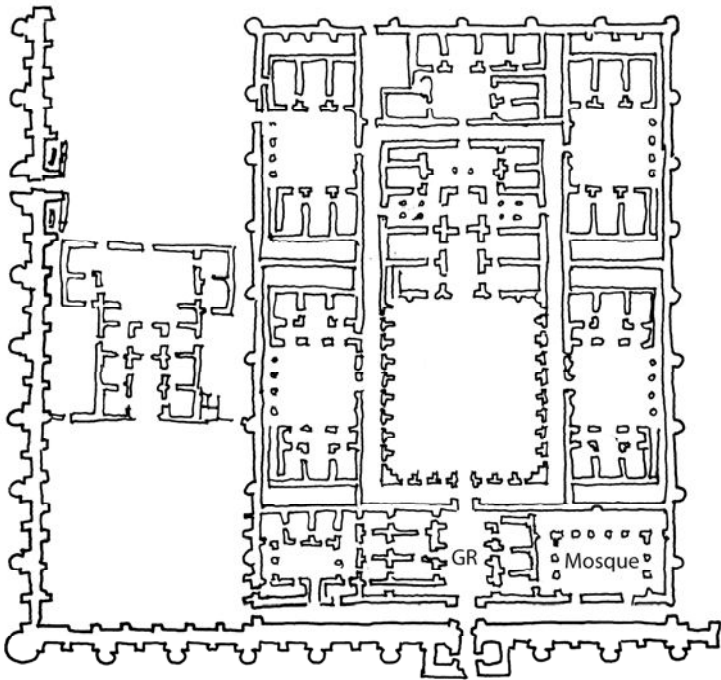

6. Ukhaidir Palace plan.

function of housing guards and screening visitors. Like Mshatta, too, it had a mosque to the right of the entrance, and this mosque in approved Umayyad fashion was accessible from outside the inner enclosure by a postern gate.⁹⁸

The above passage illustrates this tendency towards architectural deviations from perfect geometric schemes. The section of the building described by Hillenbrand is divided into three: the vestibule, a mosque to the right, and a group of rooms to the left. The vestibule is further divided into three, with a hall at its centre. As a result of the logical successive division, there are, of course, three rooms; but the rooms to the left are prolonged by additional rooms, probably for functional reasons. This is clearly a deviation from a regular geometric scheme, but this is how, in

the wake of the poets, architects deal with the excessive rigour of geometry.

The Structure of the *Qaṣīda* and the ‘Abbasid Mosque

We have seen earlier how the *qaṣīda* lends its form to Arabic poetry. Beginning in the sixth century CE, there was a gradual evolution of the poetic form that led to the preference of the *qaṣīda* over a variety of other forms. During this early period, the *qaṣīda* already displayed a clear organization in the form of a movement. This movement is imposed upon the poet who, from the beginning of his creative work, must conceptualize the goal of his poem. The consequence of this for the *qaṣīda* is that it has a clear directionality.

Directionality is an equally important characteristic of the architecture of the Islamic world, particularly in the design of mosques. A comparison between directionality in the context of the *qaṣīda*, and that witnessed in the ‘Abbasid mosque, is particularly revealing of this similarity, and I will endeavour to explain why it can be interpreted as another structural connection between architecture and poetry.

First, one can recall that Jo Tonna has already noted the parallel between architectural composition and versification. His analysis of the architectural metric patterns and their comparison with poetic metres are pertinent. But his approach does not take into consideration the changes that occurred during the history of architecture, for instance, between the building of the early Muslim monuments (mosques at Damascus, and al-Madīna) and the later buildings like the Alhambra or the Madrasa Abou ‘Ināniya in Fes, to which his article refers without differentiating between different historical periods. Another methodological problem is the assumption that architecture is the realization of a particular philosophic view. Tonna writes, to quote but two of his many statements, that through the use of intuitive fractal geometry: ‘The philosophic vision which is implied [by the poetics of Arab architecture] bestows the status of a tragic discourse, a visual comment on the nature of existence, on the buildings in which this poetics is activated.’ And, a few pages farther, ‘it [the poetics of Arab architecture] comes as close as building can to project the

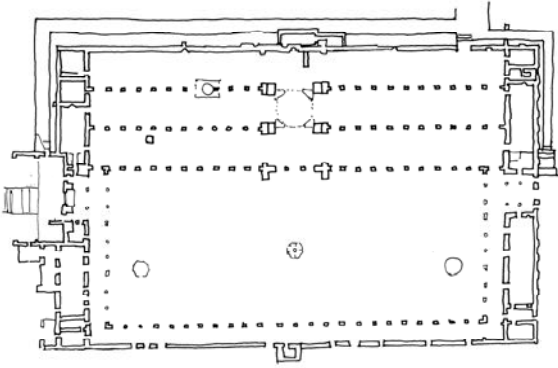

7a. The Great Mosque at Damascus plan.

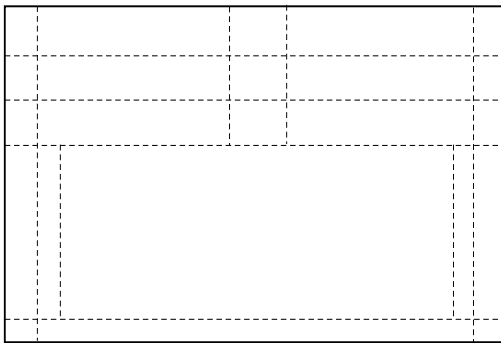

7b. The Great Mosque at Damascus diagram.

Muslim view that God is continuously creating and re-creating the world and that material things have thus fugitive and ephemeral existence.⁹⁹ Here, the influence of Masignon's view is explicit, and indeed Tonna's article shares many of Masignon's methodological limitations.¹⁰⁰

The mosque is probably the most specific element of the architecture of the Islamic world. It is also

the only element that can be found throughout the Islamic world, from the Atlantic Ocean regions in Morocco and Spain to India and the Caspian Sea. Although there are different architectural styles of mosques – Georges Marçais for instance distinguished four (Maghribi; Syrian–Egyptian; Iranian; and Ottoman) – they all share certain characteristics. The first basic component of a mosque is a minaret.

The minaret is a tower, square or circular in section. The word minaret derives from the Arabic *manar*, a synonym of *mi'dhana*, the place from which the call for prayer is done. During the time of the prophet, the call to prayer was done from the top of the roof of his

house, and it seems that the tradition was continued in the early mosques. However, the first appearance of the minaret seems accidental. With the extension of the mosque at Damascus by al-Walīd I, the entire Roman Temenos – the enclosure wall – was used. The architects, who were reusing the wall the Romans had built, integrated the existing Roman towers into the new building. The incorporation of the towers created a precedent that immediately influenced the construction of all new buildings. The Roman square towers were adopted, and they are still in use in the Maghrib, where they have become a distinctive regional stylistic feature. The functional aspect of the minaret does not seem to have particular significance; rather, it is its symbolic aspect as a visible landmark launched toward the sky that is important.

In addition to the minaret, the other components of the mosque are, second, the *prayer hall* – a covered space in which the faithful gather to perform the prayer. It is a hypostyle space, an expandable system based on the use of an internal support column or a pillar, as in the Maghribi type, or a domed one as in the Ottoman type.

Third is the *sahn*, an open space next to the prayer hall, opposite to the direction of the prayer, and surrounded on the three other sides by an arcade, a *riwāq* articulating it with the prayer hall. In the first mosques, there was no such open space.

Fourth, is the *minbar*, a pulpit on which the imam stands to give the Friday sermon. This feature finds its origin in the pulpit the prophet had in his house, and used as a ceremonial device.

And the fifth basic component of the mosque is the *miḥrab*, a niche generally placed in the symmetry axis of the prayer hall indicating the *qibla*, the direction of the prayer, facing Mecca. According to Jean Sauvaget the word *miḥrab* meant a space reserved to the master or ruler, and not necessarily a niche. The first *miḥrab* was built in the Umayyad mosque at al-Madīna, which, with its odd position as an asymmetrical feature, seems to indicate that it was built on the very place from which the prophet used to lead the prayer.¹⁰¹ The niche is in addition a feature in which statues were placed prior to Islam, in Christian Abyssinia and elsewhere. Therefore, the construction of a niche

in the mosque of al-Madīna has been interpreted as a symbolic commemoration of the prophet. The introduction of a well-known Christian symbolic architectural feature, and the common use of *Surat Annūr*, the Sura of Light, as inscription in *miḥrabs*, corroborates this interpretation.¹⁰²

An additional component, the *maqṣura*, is found in some mosques but not all. The *maqṣura* is an architecturally marked place reserved for the ruler. It is typically elevated, protected by a wooden screen and always the most richly decorated place in the mosque. This element was reserved for congregational mosques in which the Friday sermon was performed. Security concerns may explain the appearance of this feature, for three of the first caliphs were assassinated, two of them in connection with the mosque. The first Ummayyad caliph, to whom most literary sources attribute the invention of the *maqṣura*, was subject to an attempt on his life in the mosque at Damascus.

There are three explanations for the formation of the hypostyle mosque as an architectural type. The first considers the mosque as the revival of the Achaemenid Apadana, a palatial Persian audience hall with numerous columns. This theory has been dismissed because the Apadana disappeared after the conquest of Alexander and it is highly unlikely that the creators of the mosque would have had any knowledge of it. The second explanation saw the creation of the mosque as a simple progressive adaptation of the Roman forum. But this hypothesis is based on very little evidence because the mosque was first developed in Iraq, where Roman forums were unlikely to have existed. A third plausible, yet highly hypothetical explanation for the origins of the hypostyle mosque is that the design was based on the house of the prophet at al-Madīna.¹⁰³ Indeed, Oleg Grabar has suggested that the first known hypostyle mosque is that of Kufa, built in CE 670. The first step in the creation of the model must have been a spontaneous local invention of an easily built, large and expandable space with reused columns.

In the very first mosques there were no outer walls, only a ditch; many openings were used to communicate with the outside in all directions, and there was no clear or formal

place for the Imam. These constructions were simple sheds, not buildings with a formal prototype or a holy meaning.¹⁰⁴

It is through successive reconstructions that these buildings acquired a meaningful form between CE 640 and 670. In the meantime, the house of the prophet was enlarged twice, first by ‘Umar and then by ‘Uthman, and had also become a holy place. The invention of the hypostyle space and the sanctification of the house of the prophet would thus have happened independently, and been well integrated into the Muslim community before the beginning of the great Umayyad building programmes. This theoretical historical reconstruction, which applies a functionalist approach to architectural type formation, was strongly challenged by Jeremy Johns who rightly shows that it cannot be supported by the existing literary evidence. Furthermore, he writes: ‘The origin of the mosque was not a question that Islamic tradition considered especially important or interesting. Islamic tradition never once suggested that the mosque – *al-masjid* – was a specifically Muslim creation, nor that the Prophet was its creator.’¹⁰⁵ As for our concern, the question of origin can simply be put aside, for it is the evolution of the concept of mosque from its Umayyad formalization to a different form in the ‘Abbasid works that I seek to analyse in connection to the Arabic ode.

A hypostyle space is defined as an expandable system based on the use of an internal support, a column or pillar. The mosque evolved very early from a simple covered space with a single repetitive support structure to a space organized around a complex architectural feature. Thus, in the mosque at Damascus and the Aqsa Mosque in Jerusalem, the covered space was arranged around the nave, which also gave it a direction. Moreover, in mosques like that of al-Madīna and the Aqsa Mosque, a nave wider than the others accentuated that direction. In Damascus, a higher and wider central nave cut in the centre the three naves parallel to the *qibla* wall (figures 7a and 7b).

Thus, the creation of the hypostyle evolved from a diffuse system to one with architectural directionality. In Qayrawān and in the Abu Dulaf Mosque at Samarra, both the central nave and the

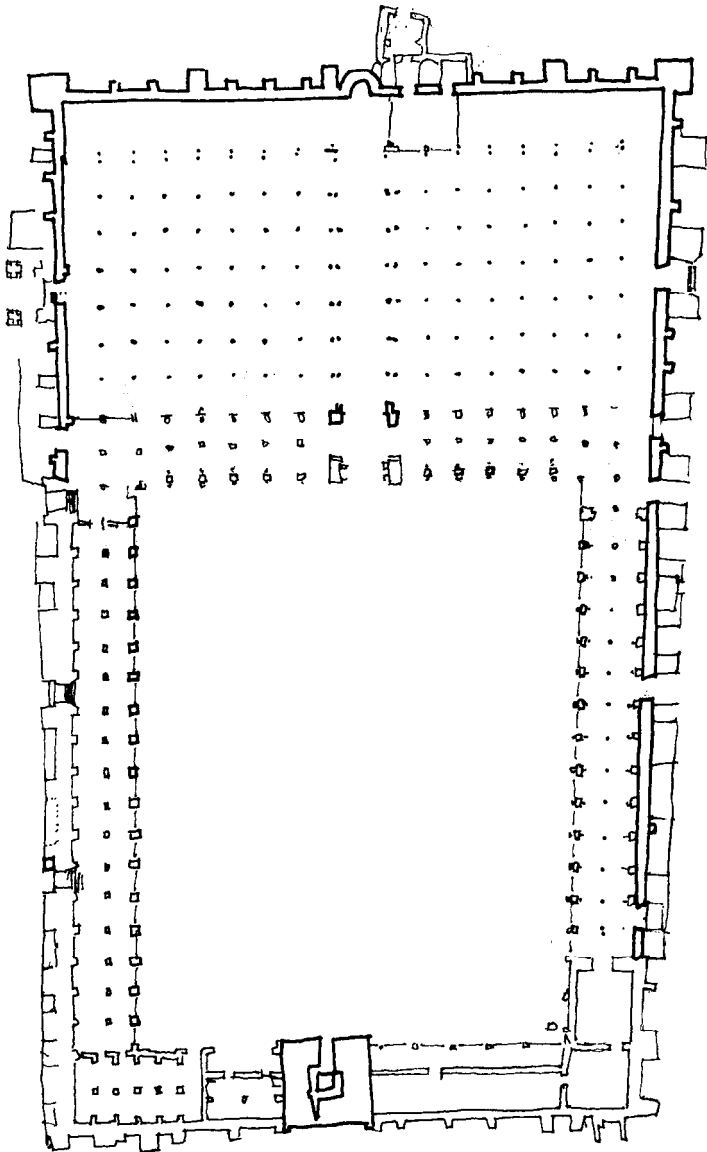

8. Qayrawān, mosque plan.

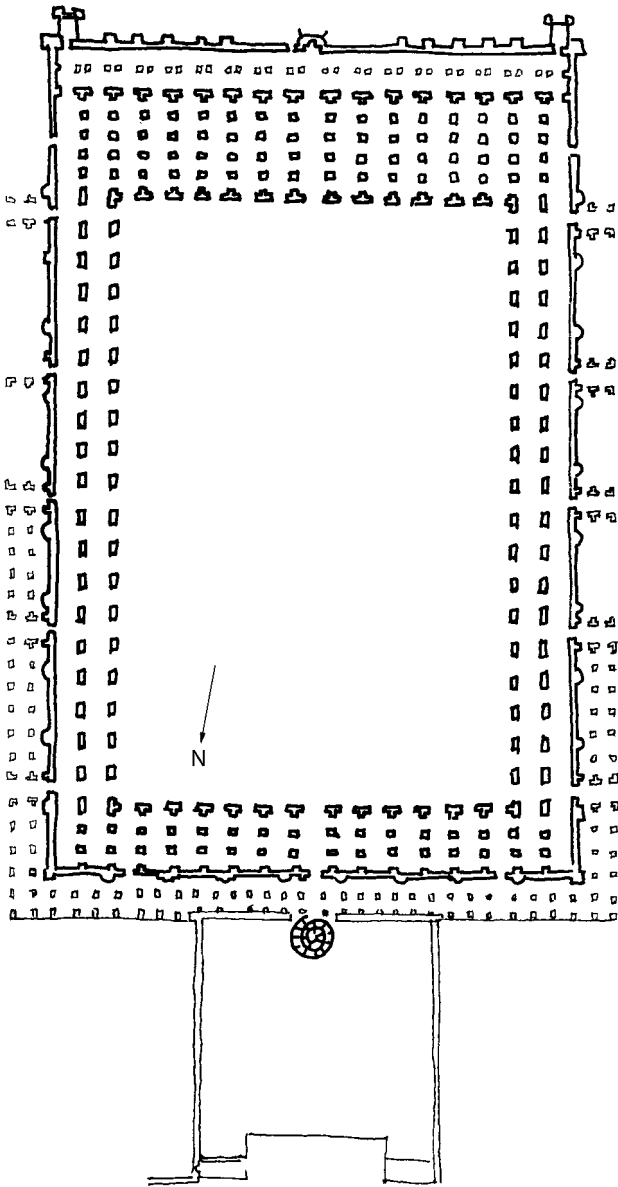

9. Samarra, the Mosque of Abu Dulaf.

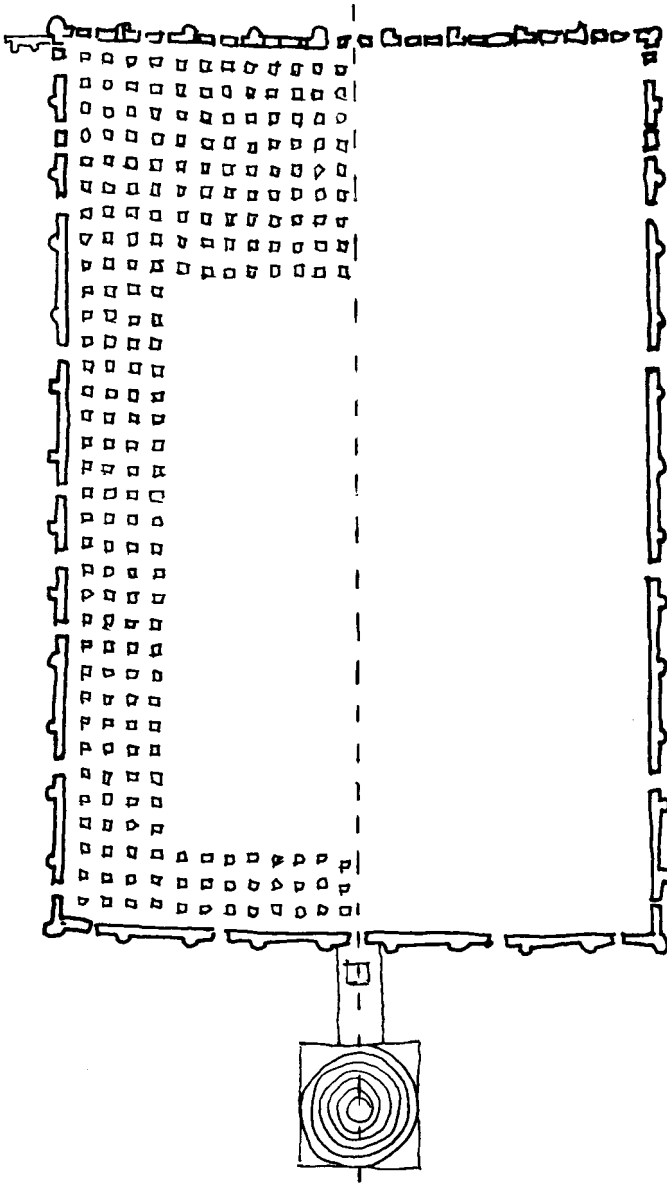

10a. Samarra, the Great Mosque plan.

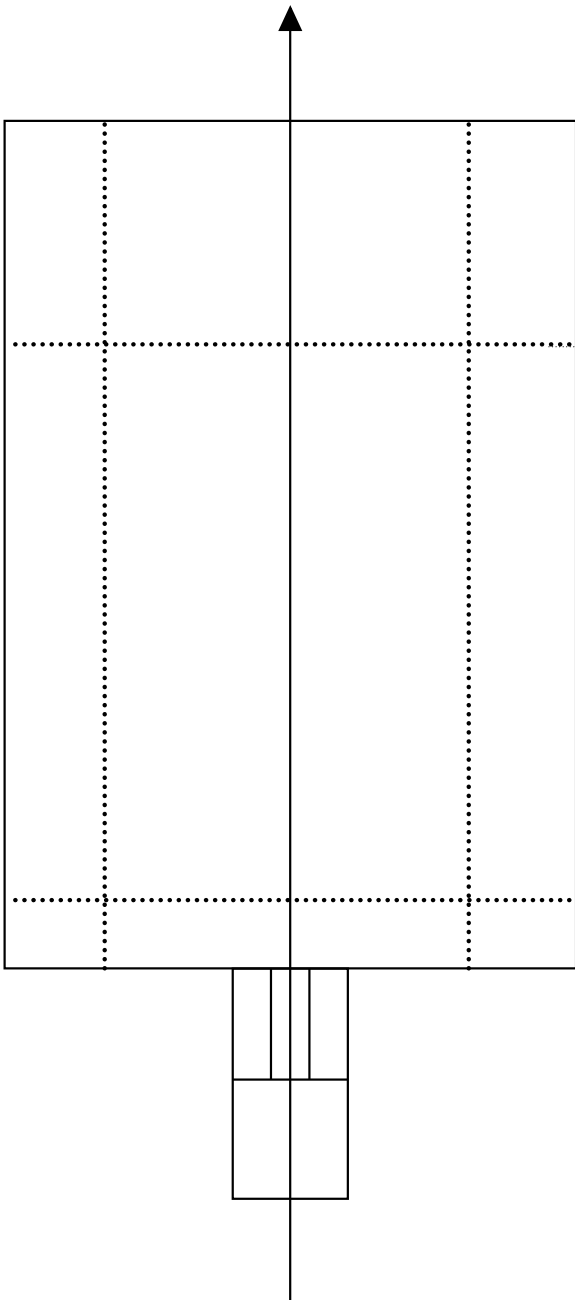

10b. Samarra, the Great Mosque diagram.

nave next to the *qibla* wall are wider than the others, which produces a T-shape marking the direction of the covered space (figures 8 and 9). This effect was even more accentuated in Qayrawān, where, in later reconstructions, domes were added at the intersection points and extremities of these naves.

The need to mark the direction of the *qibla*, the sacred direction of the prayer, was surely responsible for this formal evolution. It explains the adoption of the nave as a formal element employed to lend direction to the prayer hall, and a wider nave to accentuate this direction. It is clear, however, that religious needs or prescriptions cannot explain either the sophistication of this structure or the creation of the T-shape. The need to mark the *qibla*, which emerged from religious considerations, eventually was taken over by purely formal considerations. The placement of the minaret illustrates this formal development. The designer of the first imperial Umayyad mosque, the mosque at Damascus, had reused towers placed at the corners of the Roman Temenos. The minarets of the Umayyad mosque in al-Madīna were also positioned at the corners of the building.

This scheme changed in the mosque of Qayrawān (221 AH/CE 836), where the minaret was put in front of the central nave of the prayer hall, in the symmetry axis of the building (figure 8). A further evolution could be witnessed in the Great Mosque of Samarra, completed in 238 AH/CE 852. There, the minaret, which then took the innovative spiral form, was cut away from the building, and set free on a platform facing the gate in the symmetry axis. The great square pedestal (33 metres long and 3 metres high) was connected to the mosque by a ridge 25 metres long and more than 12 metres wide (figures 10a and 10b). Hillenbrand described this evolution as follows:

The disposition of minarets at the corners of the mosque, as at Fustat, al-Madīna and Damascus, had already established their use as an articulating device. Qayrawān developed that function still further. It was only a matter of time before the last refinement was added and the minaret was exactly aligned with the *miḥrab*. The great Mosque of Samarra is the earliest and best example of this culmination.¹⁰⁶

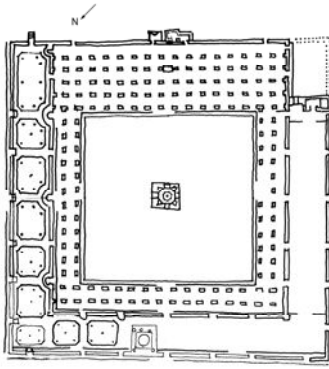

11a. Cairo, the Mosque of Ibn Tulun plan.

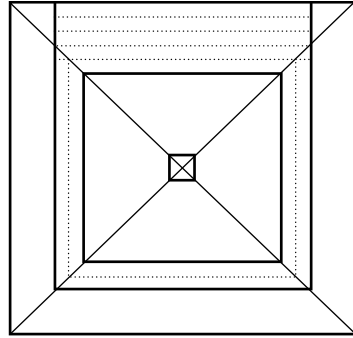

11b. Cairo, the Mosque of Ibn Tulun diagram.

It seems that the early version of the Great Mosque of Qayrawān lacked a *riwāq*, the arcade on the three sides of the courtyard that provides additional covered space, and more importantly an architectural articulation of the *saḥn* and the prayer hall.¹⁰⁷ This defect was remedied in the Great Mosque of Samarra, where the articulation was reintroduced, and a *riwāq* built. This solution was immediately adopted in the chief remaining 'Abbasid mosques, the mosque of Abu Dulaf, Samarra (finished 247 AH/CE 861) where the articulating device and the free-standing minaret were used, and the mosque of Ibn Tulun, Cairo (finished 264 AH/CE 877) in which the present day minaret combines a tower section and a spiral upper part (figure 9 and figure 11). This solution was so fashionable that it is not unreasonable to suppose that earlier mosques were supplied with new minarets standing in the central symmetry axis. Creswell writes that in Damascus, 'Alongside the northern entrance is a third minaret dating from the end of the twelfth century, but there was an earlier minaret at this point dating from before 985, for it is mentioned by Muqaddasi.'¹⁰⁸ Even in Umayyad Spain the mosque of Madīnat-al-Zahra (CE 941) had a minaret in a similar position, and in the mosque of Córdoba a minaret positioned comparably was constructed by 'Abd ar-Rahman III in 340 AH/CE 951 (figure 13).¹⁰⁹

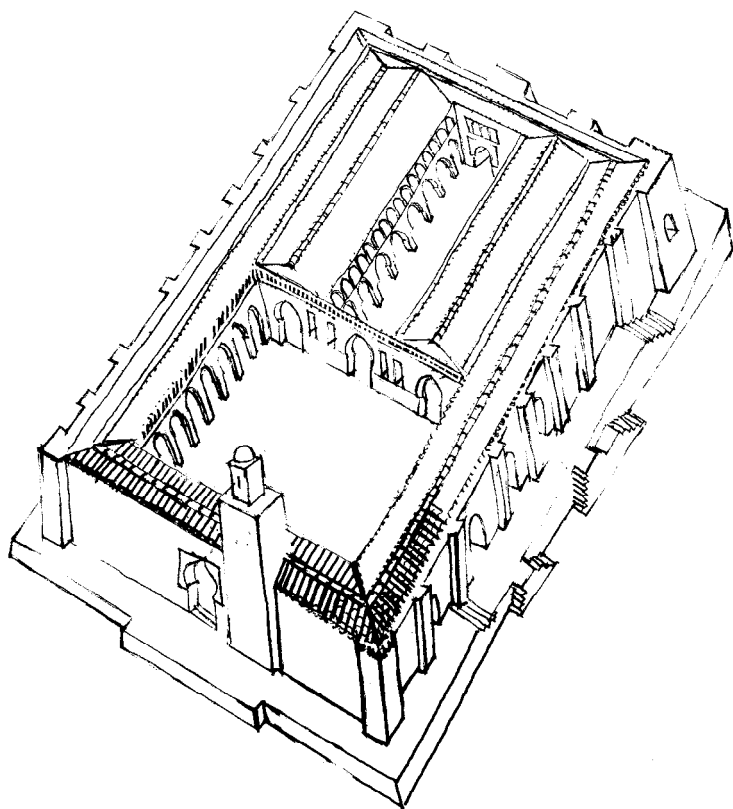

12. Madinat Al-Zahra, Great Mosque.

This new formal elaboration was made visually evident by the addition of a large, open enclosure, called a *ziyāda* (addition). In the Great Mosque at Samarra the principal structure was surrounded by a rectangular enclosure to the east, north and west (figures 10a and 10b): 'This great rectangle, writes Creswell, was placed in a still greater one which surrounded it on all four sides, so as to leave three great open areas on the east, south, and west, and a much narrower one on the north.'¹¹⁰ But the prayer hall, which was covered by a flat roof, was, as John Hoag remarks, multidirectional, 'like those of nearly all the other so-called hypostyle mosques of Iraq.'¹¹¹ This defect was soon repaired in the

mosque of Abu Dulaf, in which the scheme created in the Great Mosque of Samarra was supplied with a wider central nave and a larger nave next to the *qibla* wall, providing the prayer hall with the formal effects of the T-shape structure. It appears therefore, that here a synthesis between the early Umayyad type and the 'Abbasid innovations was reached (figure 9).

The rationale behind the addition of a *ziyāda* cannot, to my mind, be explained by any conceivable utilitarian function. Rather, formal sophistication seems to be the best explanation for this innovation. In the new scheme, where the minaret strongly emphasizes the directional organization of the mosque, the *ziyāda* acts as a spatial clearance, allowing the beholder to perceive the outline of the ensemble.

Of course, a total perception of the structure is possible only with motion, a visitor approaching the building realizes upon his entrance into the *ziyāda* that here is a whole building, isolated from the outside. From the north side, the spectator can also see that the minaret is connected to the sanctuary exactly in the symmetry axis of its northern side, and he would perceive the entire directional organization if he enters the *sahn*, for there he would be able to see both the minaret, and the wider central nave of the prayer hall (plate 12 and plate 14). The 'Abbasid type of mosques, epitomized by the mosque of Abu Dulaf, has two related primary formal characteristics. First, despite the spatial clearance provided by the *ziyāda*, the 'Abbasid mosque apparently lacks an exterior façade (plate 15). This can be deduced from a number of sources. These include:

- the absence of even a single entrance on the minaret side of the mosque of Qayrawān.
- The free-standing position of the minaret in the two mosques in Samarra, and in that of Ibn Tulun in Cairo, prevents the 'reading' of the minaret side of the building as a façade, for the impression imposed on the beholder is that of the relationship between the soaring spiral minaret with the horizontal parallelogram building. However thoughtful they may be, the decorative effects of the bastions, towers, arches and other

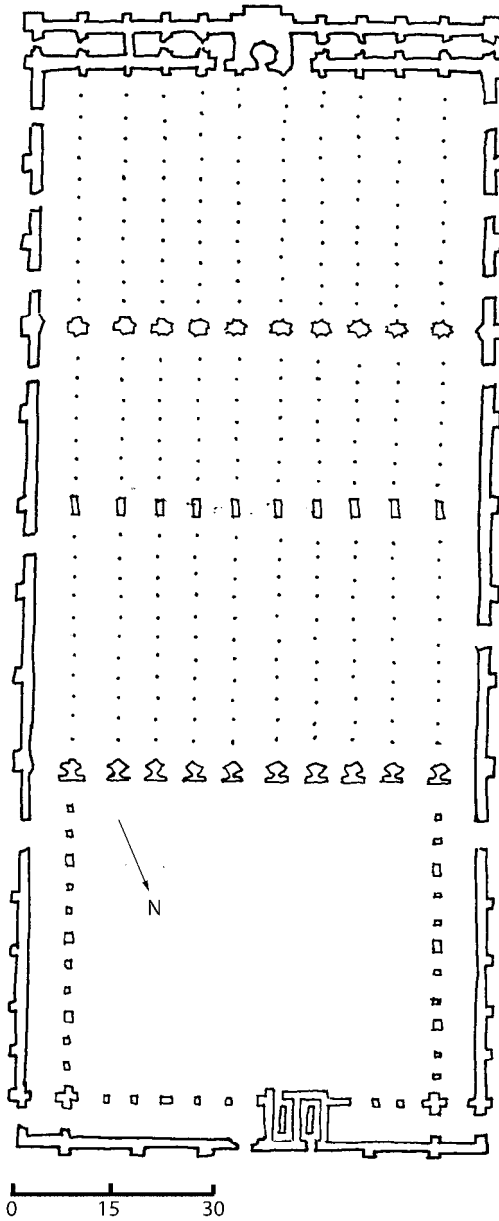

13. Córdoba, the Great Mosque plan.

motifs that clothe the walls and the minaret in Samarra do not provide the building with a façade meant to be seen from a particular point of view.

- Finally, the apparition of the exterior façade in Fatimid architecture in the tenth century suggests that it was absent from the earlier ‘Abbasid type. It is worth noting that the creation of the exterior façade in Fatimid architecture was accompanied by the abandonment of the minaret standing on the central axis; and in the sole Fatimid mosque with minarets, the al-Ḥākim Mosque in Cairo, CE 990–1013, these are positioned in the corners (figure 14).

The second major characteristic of the ‘Abbasid type of mosque is the movement, and the call into play of the body. As indicated above, the structure of the mosque envisages a moving beholder. Upon his entrance into the *ziyāda*, the visitor perceives the unity and isolation of the building. From the north side he can also perceive the relation of continuity between the minaret and the sanctuary, and the beginning of a symmetry axis. He can then move on, and enter the *riwāq* from which he will have an open view on the *saḥn*. If he continues to move, from the latter he will be able to contemplate the entire directional organization of the ensemble, viewing both the minaret and the wider central nave of the prayer hall. The central nave will guide his eye toward the *miḥrab*, which marks the axis of the movement on the *qibla* wall. Then, viewing the minaret from the inside, its spiralling thrusts his eye energetically upwards into the sky (plate 14).

The great architectural composition of the ‘Abbasid mosque, whose type was first fully accomplished in the mosque of Abu Dulaf, Samarra, must be considered an achievement motivated by a search for a formal order. The fact that its first impetus was given by the religious need to indicate the *qibla* does not alter the centrality of the search for a formal order. But, as al-Jāḥiẓ would suggest, the search for formal order should not be interpreted as a goal in itself. For, like the Arabic ode, the *qaṣīda*, which is composed of four parts (*dikr*, *nasīb*, *raḥīl*, *madīh*) organized with the goal of producing a perceptible movement, the ‘Abbasid mosque is

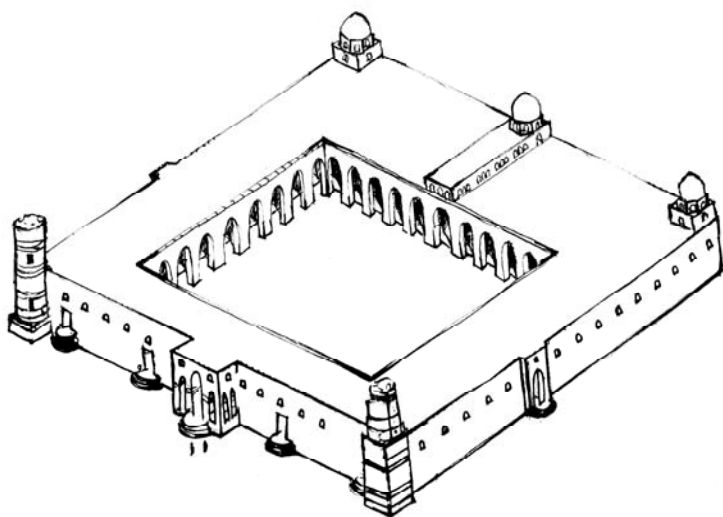

14. Cairo, the Mosque of al-Ḥākim.

composed of distinct parts organized with a strong direction conveying the sense of movement. Like the reader who is explicitly addressed in the book, and invited to move from one part of the book to another, the beholder of the mosque is invited to move about, to walk through and around the structure, and thereby to discover it. Furthermore, there must be a good equilibrium between the parts of the Arabic ode; the good poet, writes Ibn Qutayba in the mid-ninth century, 'maintains the equilibrium between the parts [of the *qaṣīda*]. He does not make one longer than the others, does not make it too long and bore the listener, nor does he stop while souls are still thirsty.'¹¹²

Similarly, there is a sense of proportion in the contemporary mosque. Finally, as in the *qaṣīda* where the movement is aimed at a patron to whom the poet is addressing a request, the movement in the mosque leads the faithful literally towards the *qibla*, but symbolically towards God, for the prayer is always addressed to Him, and it is towards His face that the faithful turn during that ritual, which is equally a request for grace and mercy. This, it should be noted, is consistent with all later symbolic associations

of the *miḥrab*, the niche indicating the *qibla* with light, and the Sura 24:35:

God is the light of the heavens and the earth; the likeness of His light is as a niche in which is a lamp, the lamp is in a glass, (and) the glass is as it were a brightly shining star, lit from a blessed olive-tree, neither eastern nor western, the oil whereof almost gives light though fire touch it not – light upon light – God guides to His light whom He pleases, and God sets forth parables for men, and God is Cognizant of all things.¹¹³

THE PALACE AND THE QAṢĪDA

Finally it is worth noting that the same architectural directionality is found in 'Abbasid palaces, where the principle of successive divisions is equally at work. Hillenbrand makes a pertinent observation when he compares the T-shaped structure of the mosque with that of the Balkuwara Palace in Samarra (figure 15). The Balkuwara is a palace with a double fortification, the outer one stretching about 1.25 kilometres to each side. This palace, which Creswell identifies as the work of al-Mutawakkil, is the subject of a long and fascinating poem by Ibn al-Jahm that I shall analyse in Chapter 6.

Ernst Herzfeld described the inner palace as a rectangle 'divided into three parallel strips, as at Mshatta, and also in the Qasr al-ʿāshiq. The middle strip contains, one behind the other, the monumental gateways, the Courts of Honour, and the Throne-Rooms'.¹¹⁴ The three successive courtrooms of Balkuwara are arranged according to a strong axial symmetry leading to the cruciform throne room. The latter is not only the visual focus of the entire composition but also the focal point of building materials used symbolically, such that: 'The material used for the building improves in quality from the surrounding walls of the castrum, built of whitewashed mud, to the mud brickwork of the first court and side tracts, and the baked brickwork of the third court and the Throne-Room.'¹¹⁵ The central role of the throne room is equally enhanced by the skilful consideration of visual

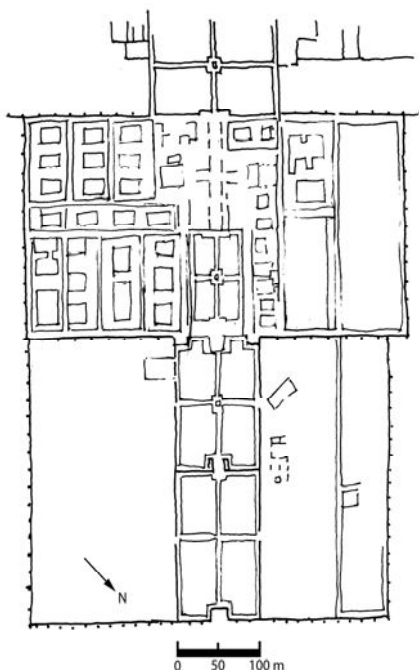

15. Samarra, the Bakuwara Palace, plan.

effect. Not only are the views from it monumental, but the uneven soil was exploited to create increasingly higher levels leading to the throne room, which is the highest point inside the palace.

Comparing this building with a contemporary palace at Istabulat, Hillenbrand writes, 'the emptiness of the northern and eastern quadrants emphasizes the T-shape of the remainder.'¹¹⁶ He also suggests that, given the significance of the T-shape in the mosque, it should be afforded a ceremonial

role. Certainly, what we have here, regardless of the architectural origin of the composition, is the same *mise en scène* of the movement required in the *qaṣīda* as in the mosque. A royal ceremonial is, indeed, nothing more than an orchestrated movement leading a subject towards a patron, for the axial composition of the palace should be read both from the throne room towards the perspectival views and from the gateways toward the throne room.

Another interesting conclusion can be drawn from this parallel with the *qaṣīda*. The architectural composition of the mosque developed in reference to the composition of the palace. Each of the elements of the prayer hall in the mosque has a parallel in the architecture of the palace. For example, the *miḥrab* has a parallel in the triconch form of the throne room in the palace at Mshatta. It is significant that among other meanings, the term *miḥrab* could

denote the specific place in a palace where the ruler stood or sat.¹¹⁷ The *minbar*, which might find its origin in the raised throne from which the Sasanian king watched his army, did occasionally serve as a throne from which the ruler addressed his subjects. The *maqṣura* is by definition a royal feature since it is the place reserved for the ruler. The dome over the *miḥrab* may also be interpreted in connection with royal ceremonials. The royal character of the dome predates Islam, and it is widely believed that Mu'awiya, the first Umayyad caliph, had a green dome constructed as a symbol of his royal status.

The organization of the prayer hall, with an axial nave and its other symbolic features, 'recall a throne-room with an aisle for attendants and a place for the throne in a niche preceded by a dome'.¹¹⁸ Despite the fact that on rare occasions soldiers lined up along the axial nave – which is, incidentally, a fact that contradicts the ritual requirements of prayer – the ceremonial influence seems an unsatisfactory explanation for the formal development of the mosque. For, as Oleg Grabar argued, most literary sources refer to 'unique, special occasions, such as the inauguration of the mosque of al-Madīna. And, more important, the internal organization of an axial nave occurred far more frequently than royal ceremonies would justify and at the same time is not found in a number of clearly royal mosques.'¹¹⁹

The structural connection between architecture and poetry provides a more satisfactory explanation for the parallel between the architectural compositions of the mosque and palace. For this relationship between *qaṣīda*, mosque, and palace suggests the workings of like 'mental habits', and can explain the architectural similarities between the two types without needing to appeal to a functional or historical influence. The two types of building have comparable organizations because they are created through the same *modus operandi*; they are the product of similar styles of thinking and practice.

Al-Riwaya wa al-Taḍmīn

Most scholars accept the hypothesis that architectural planning relies on geometrical constructions comparable to those of decor-

ation. However, it appears that most buildings not only display some obliquity in their plan, but also deviate more or less significantly from strict geometric patterns. How then is one to explain these deviations of the actual buildings from ideal geometric forms?

There are two kinds of deviations. The first is composed of deviations deliberately incorporated in the plan, which I shall call poetic deviations; the second encompasses accidents that occurred in the execution of the construction, or accidental deviations.

In describing the plan of Khirbat al-Mafjar, Hamilton writes:

We can easily understand how the obliquity of the overall plan [of Khirbat al-Mafjar] came about. What is more puzzling is that the Umayyad builders did not notice, or did not bother to correct, what appears to us a glaring inaccuracy. The fact is that they allowed it to stand, as similar discrepancies were overlooked elsewhere. We cannot hope to explain this, but can only reflect that a carefree attitude in matters of precision is entirely consistent with well-known and amiable traits in the Arabian temperament today.¹²⁰

Rather than a trait of Arabian temperament, this 'carefree attitude' simply points to an awareness of the existence of the intangible difference between the plan of a building and the way in which the beholder perceives it. I suggest this awareness explains the tolerance of architectural planners for geometric imperfections: if the beholder cannot perceive the obliquity, why indeed bother to correct it? Given the emphasis in the architecture of the Islamic world on shaping the beholder's spatial experience, the existence of such imperfections, which remain invisible to the ordinary eye, would indeed not matter.

The deviations I call *deliberate* have to do with the constraints proper to architectural planning, and often appear to be influenced by the dictates of functionality. Here, I suggest that there are further parallels between architectural planning and poetic craftsmanship for, in architectural planning, the deliberate

deviations from the geometric constructions are comparable to poetic alterations.

The argument is, in fact, more complex because every building is related to the monuments of the past; in the early Islamic period, architectural planning consisted of the appropriation, modification and elaboration of schemes developed in earlier buildings. This process is based on

modes of appropriation that renew and recreate meanings based on old tropes, with recourse to mechanisms of change comparable to genres of poetic alteration (*ziḥāfāt*, and *ʿilāl*).

It is well established that the Umayyad builders not only employed the vocabulary of Roman architecture (columns, capitals and arches), but that they also adopted some of its architectural types and methods of architectural planning. Thus, the builders of the Dome of the Rock, the earliest surviving Umayyad monument, were inspired by the plan of a Christian mortuary monument. In his *Filiation de Monuments grecs, byzantins et islamiques*, Michel Ecochard has shown that the planning method of the Dome of the Rock – the rotating of a square within a circle with a radius of 26.87 metres – was comparable to that of earlier Christian monuments, such as the Church of the Ascension in Jerusalem, with a difference of only ten centimetres (figure 16).¹²¹ It is also recognized that the façade of the Umayyad Mosque at Damascus was a simple variation on a Syrian church façade, and the borrowing and adaptation of architectural types – like the Roman bath, villa rustica and frontier fort – also follow this pattern.¹²²

These examples indicate deliberate recourse to a well-

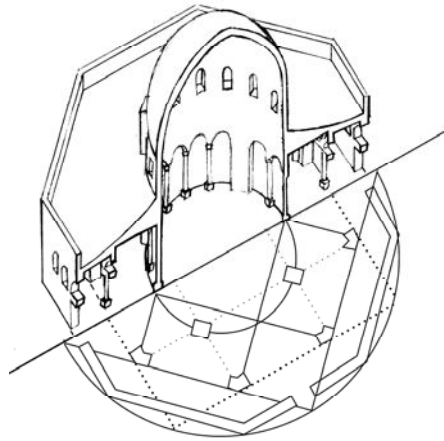

16. The Dome of the Rock, Jerusalem, axonometric view.

established architectural vocabulary – including some fixed syntagms (combinations of elements in plans or façades), and recognized methods of planning. The existence of this vocabulary is consistent with the absence of a need for a system of architectural notation that could have been used to show the patron/client an image of the proposed project. This process is, in many respects, comparable to the practices of poetic creation in which poets have recourse to pre-existing tropes. Two such practices come immediately to mind: *sariqa*, or theft, and *taḍmīn*, or borrowing from old masters.

A mechanism of innovation and borrowing from the past comparable to *taḍmīn* is also at work in architectural planning. Al-Mutawakkil is said to have created a new fashion in palatial architecture, which was, in fact, borrowed from an older type of building from al-Ḥīra. The historical character of his palatial architecture prevented neither the work from becoming fashionable nor the author from being positively credited with its invention. More generally, many historians, from Creswell to Hillenbrand, pointed out the lineage of early buildings. Furthermore, Grabar and other commentators have remarked that comparable plans were used for different types of buildings: the plans of the palace of Qasr al-Ḥayr West and of Khirbat Minyah (figure 18) look like that of the Ribat of Susa (figures 17a and 17b).

As I explained above, one method of planning employed in Umayyad and 'Abbasid architecture was based on the so-called successive subdivision into three. The parallel of the palace of Ukhaidir (figure 6) and of Mshatta (figure 3), with three tracts receiving most of the living quarters, is remarkable. But whereas Mshatta nearly corresponds to the perfect geometric scheme of successive subdivisions, Ukhaidir deviates slightly from the scheme, as in the section of its entrance.

This section is divided into three: the vestibule, a mosque to the right, and a group of rooms to the left. Yet, on the side of the mosque, the subdivision does not respect the lines of the general subdivision of the whole. The eastern wall of the mosque (towards the entrance) does not continue the wall marking the line of division of the side tract from the central tract. This deviation can

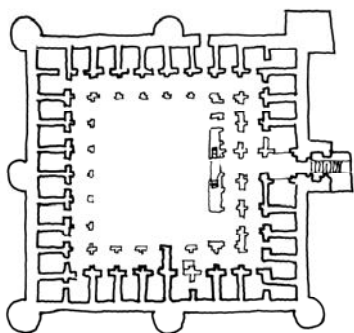

17a. Susa: the Ribat plan.

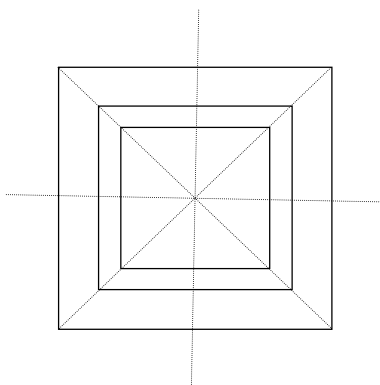

17b. Susa: the Ribat diagram.

be explained by the proportions of the mosque, which do not respect the standard subdivisions into three.

This type of deviation is also seen in the vestibule, which in turn is divided into three with a hall at its centre. As a result of this logical successive division, there are three rooms positioned on each side (with a ramp and another deviation). The rooms to the left are prolonged with other ones, whereas on the right side of the vestibule, the equivalent space was integrated into the mosque. This deviation from the regular geometric scheme was clearly deliberate: it is a mechanism comparable to the poetic alterations of the poets called *'ilal* and *ziḥāfāt*.

I have thus shown how similar principles structure both poetry and architecture – the primacy of the relations of elements over the elements themselves; the potentially infinite expansion of the composition; aesthetic selection of

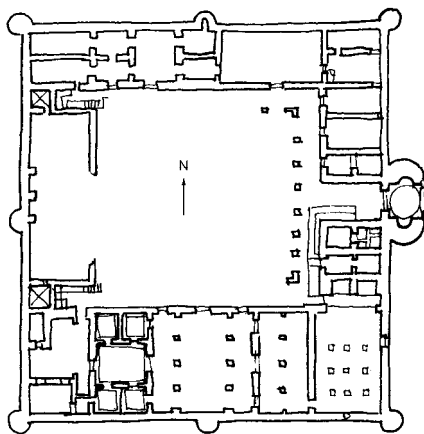

18. Khirbat Minyah, plan.

elements; successive divisions of space and voice; and a clear directionality of the composition with a precise aim. In the same way, both architecture and poetry allow the practice of deliberate deviations from the regular metre/geometric scheme. Thus, one can assume that Ibn Qutayba's assertion that 'Eulogy is building, and satire is building' is fully justified. Moreover, if poetry is building, it can also be said that architecture is poetry. Both, indeed, have recourse to the same formal principles. But, instead of stating, for instance, that the principle of the successive, symmetrical subdivision into three is the application of *al-taqṭī*, poetic division, in architectural planning, it should rather be stated that *al-taqṭī* and the successive, symmetrical subdivision into three are different applications of the same mental habit. Architecture is poetry because both are built according to the same design principles and are the product of the same mental habit.

4

Architecture and Myth¹

ḤADĪTHU SINIMMĀR

Some Arabs said about the killing of Sinimmār the Byzantine by a king that when the king climbed on top of the Khawarnaq, he saw buildings he had never imagined seeing, and regarded the view from there. He feared that if Sinimmār remained alive he might build buildings of comparable magnificence for another king after [the king's] own death; [the king] then threw [Sinimmār] from the roof of his palace. That is why al-Kalbiyu, the poet, said when he got into trouble with a king:

He rewarded me badly, may God reward him back
the reward of Sinimmār who had committed no sin
Except erecting a building for seventy years²
topped by vaults of lead and tiles
Upon seeing the palace completed, the king sighed
yet like a mountain he boasted pride and arrogance
Thus Sinimmār thought he had secured all valuable gifts
and won the king's friendship and affection
It is then that the king ordered that he be thrown from the
roof
certainly that is the most uncanny of misfortunes.

(Al-Jāḥiẓ)³

It is said that one of the wives of the Prophet Muhammad built an extension to her room during his absence. When the prophet returned, he ordered that the extension be destroyed, summoned

his wife, and said: ‘The most unprofitable thing that eateth up the wealth of a believer is building.’⁴ This is why it is believed that the prophet had a negative attitude towards architecture. The contempt of architecture deduced from this story, paired with certain assumptions about pre-Islamic Arab bedouin nomadism, have been used by K. A. C. Creswell, among others, to construct a vision of the architecture of the early Islamic world in which a unilateral negative attitude and architectural vacuum were presupposed. In his article, ‘Creswell’s Appreciation of Arabian Architecture’, G. R. D. King brilliantly challenges this assumption and, pointing to the prominent place of architecture in pre-Islamic Arabia, suggests possible continuities between the pre-Islamic and Islamic eras.⁵

The collection of stories, historical narratives and poems that describe grandiose Arabian architecture in pre-Islamic times comprise a luxurious corpus of legends. When read together and contrasted, these tales, written between the eighth and tenth centuries CE, elucidate the prevalent attitudes towards architecture during the periods that were contemporary to their authors. I shall thus present these legends, their developments and contradictions, as artefacts that enable us to reconstruct how Muslims might have thought about and discussed architecture during the periods in which these accounts were written.

The dates of these myths are very important in this respect and are, indeed, earlier than what one particular record, dating back to the tenth century CE, namely *Al-Iklil* by al-Hamadhāni, otherwise known as *The Antiquities of South Arabia*, may suggest. Many authors – geographers as well as historians – mention the literature of grandiose secular architecture in early Islamic times. Some scholars have suggested that archaeological investigations at the sites designated by these myths might uncover interesting results.⁶ Indeed, excavations known as ‘the Oxford excavations at Hira’ were conducted in the late 1920s, but did not reach the earliest levels of the site. Thanks to recent excavations in Yemen, *The Antiquities of South Arabia* proved to have more of a historical basis than was assumed until recently. There is a tendency among contemporary scholars to seek to verify the extent to which these

myths might reflect realities. While archaeologists have uncovered some evidence suggesting historical bases for these myths, the findings have neither been conclusive nor have they exactly verified the myths. While archaeological excavation can, indeed, indicate whether certain monuments actually existed, thus providing some insight into the history and architecture of the period, I should like to suggest that uncovering the historical veracity of the myths is not necessary to garnering an understanding of what these myths might tell us about the attitude towards the arts during the early Islamic period.

In this chapter I explore what the literature of grandiose secular architecture might reveal about the attitude of Islamic societies towards the arts in general and architecture in particular. Different interpretations of this corpus are possible, depending on the theoretical orientation of the approach. Previously, analysts have deemed the myth of grandiose Arabian architecture significant inasmuch as it points to the existence of architecture predating Islam. All archaeological investigations have been based on this purview. However, this corpus of stories can also be read for its insights into architecture in later periods. I believe that it is important to explore the myths for what they may contain about pre-Islamic architecture and for what attitudes they might reveal of the Islamic period towards pre-Islamic Arabian art, as well as towards contemporary art and architecture. It would be of great interest to find out exactly how to analyse these myths correctly and to what purpose, for it would bring to light a new historical approach.

The simplistic answer to what attitudes might have been to pre-Islamic architecture is that Islam could only have had a negative attitude towards the arts of pre-Islamic Arabia. As Oleg Grabar writes:

But for a definition of attitudes rather than specific facts, the key point is that, regardless of what pre-Islamic art may have been known to the Arabs, it was largely disregarded in later Muslim tradition. There are many reasons for this, not the least of which is the rather

systematic attempt of later times to eradicate the *jahiliyyah* past, the time of ignorance, or all the centuries which preceded the Revelation to Muhammad. Whatever the pagan Arabs may have had could only be of negative value; it was something to be rejected.⁷

More recently, and without openly challenging this hypothesis, Nuha N. N. Khoury offered a reading of the Dome of the Rock as 'a monument that projected images of ancient dynastic shrines such as Mahārib Ghumdān and Mahārib Suleyman, and stood as an emphatic point of transfer from the old Islamic caliphate to a new Umayyad dynastic regime'.⁸ Her interpretation presupposes that pre-Islamic architecture was at least known and respected in the early Islamic period.

I should like to suggest that the question of how Muslims viewed pre-Islamic architecture can be better understood through studying literary sources that describe Arabian grandiose architecture than by turning to the condemnation of *al-jāhiliyya*, the time of ignorance, by the pious. This literature (in part assembled in *Al-Iklil* by al-Hamadhāni, but also reported in other literary sources) provides rich information about the intellectual context in which it developed; and it is surprising to note that this has not yet been studied as such.

Thanks to its very nature, this literature provides more pertinent information about society than about the architecture it describes. As a corpus of myths or legends that describes the origin of architecture in pre-Islamic Arabia, a very little known architecture, its content is more concerned with specific historical events than with architecture *per se*. A careful analysis of these legends thus provides more information on how Arabs perceived architecture at a particular time than about architecture in general. It also provides a portrait of the status of the 'architect' in Arab society. Furthermore, when considered in their different versions, these legends are more meaningful: they changed over time and their different versions show an evolution in the perception and representation of architecture in the societies that shaped them.

Sinimmār and al-Khawarnaq: A Philological Approach

A poem recounting the myth of a palace called al-Khawarnaq, built by the architect Sinimmār, is preserved in many Arab sources; based on these sources, scholars have dated the palace to pre-Islamic times. Hanṭala Ibn Ash-sharqī, a contemporary of the prophet, is reported to have said: ‘By Allah and al-‘Uzza, he rewarded her and her master as Sinimmār was rewarded; that is how those are rewarded who do not keep their promise.’⁹ This remark, paired with the poem in question, indicates that not only was grandiose architecture an ordinary discursive trope, but that the personage of Sinimmār was also renowned in pre- and early Islamic times.

I shall first summarize how this mythical figure has been approached in the academic literature, and then show how a different analysis can offer a telling image of this famous character and significant insight into the social reception of architectural works. In 1907, the French scholar Jean Halévy published a paper in which he discussed the origins of the names Khawarnaq and Sinimmār.¹⁰ His paper, which addressed what French scholars call a *tradition populaire*, a folkloric tradition, sought to trace the paths by which a literary tradition is transformed into tales and legends. It is through this trajectory, he argued, that the populace memorizes historical events. Halévy introduced his argument by rejecting an earlier etymological study that suggested an Assyrian origin for the name Sinimmār and a Persian one for Khawarnaq.¹¹ The author also refuted a hypothesis that suggested a Babylonian origin for Sinimmār, which would be *Sin-immār*, ‘the moon god shines’, as well as a possible Persian derivation for Khawarnaq, which would be *Khw+arnak*, meaning ‘which has a nice roof’.

Halévy bases his own interpretation on a legend describing the cult of the Egyptian sun god in Heliopolis, Syria. He argues that the Arabic legend was born out of the similitude of two topic names Heliopolis, city of the sun, and Khawarnaq, splendour of the sun, and the death of Sinimmār, the architect was an Arab invention based on the belief that the death of a man is necessary to the strengthening and longevity of buildings.

One must recognize that both the Assyrian and Halévy’s Syrian-

Egyptian philological derivations are seductive, and that their semantic and morphological similitude is equally attractive. While philological analysis can reveal the origin and the meaning of words by pointing to similitude of sound or other qualities, an approach that focuses exclusively on linguistic origins is unable to capture the *raison d'être* of a legend – its social meaning and the evolution of its content. Furthermore, it is possible to point to the way in which an analysis that is too preoccupied with the question of origin develops a mythical quality; in eschewing all other interpretations, it favours a myth of origin, which is a myth *par excellence*.

Halévy's philological and etymological readings beg the question: how should one conceive of the relationship between myth and reality? Does myth convey information about reality? If so, what is its relationship to reality? Is it a mirror of reality, or do myth and reality weave a more complex relationship? Claude Lévi-Strauss suggests that:

The myth is certainly related to given facts, but not as a representation of them. The relationship is of a dialectical kind, and the institutions described in the myths can be the very opposite of the real institutions. This will always be the case when the myth is trying to express a negative truth. ...

This conception of the relation of myth to reality no doubt limits the use of the former as a documentary source. But it opens the way for other possibilities; for in abandoning the search for a constantly accurate picture of ethnographic reality in the myth, we gain on occasions, a means of reaching unconscious categories.¹²

Consistent with this conception, I should like to suggest that legends, if analysed appropriately, can provide rich information about society and its evolution. They are social representations of a particular object. Like myths, they are cultural phenomena or collective representations. They are objectified statements made by a society about the world and the place of human beings in it. Legends should not be considered in opposition to a scientific or rationalistic view of the world. Rather, they are symbolic objects

and should therefore be analysed as such. Some scholars have spoken of myths as expressing the 'half forgotten' origin of humankind, and of historical events. Accordingly, myths keep the memory of these events and repressed human nature in a symbolic representation. More recent scholarship has tended to consider that myths explain the paradoxes of society, its relationship to nature and the position of man in the world. Because myths must explain the paradoxes of society and the place of man in the world, their goal is to explain the present, not the past. But to explain the present they always turn to the past: a present situation finds its explanation in a past event. Myths articulate a causal relationship between the past and the present.

Claude Lévi-Strauss summarizes this by saying that myths project the synchronic axis – that is, all contemporary events that constitute the present – on a diachronic axis, or those events that comprise history, which means that a present situation will not be perceived in its synchronic structure but through the lens of an event that happened in the past.¹³ In other words, as Lévi-Strauss explains, 'the narrative is both "in time" (it consists of a succession of events) and "out of time" (its significant value is always current).'¹⁴ This means that to understand the significance of a myth, we need neither to possess accurate knowledge of the past nor to confront its statements with specific historical evidence. Instead, we should consider the social context in which it circulates.

More simply, it can be said that a myth is a response to a particular problem that a society senses or identifies, and with which it endeavours to cope. The problems that myths try to solve range from the question of the origins of human being to the definition of gender relationships, the succession of night and day, and the cyclical nature of the seasons. The way myths express the solution to a problem, which typically remains unconscious or simply unformulated, is necessarily related to that problem itself. 'There must be, and there is, a correspondence between the unconscious meaning of a myth – the problem it tries to solve – and the conscious content it makes use of to reach that end, i.e. the plot.'¹⁵

Lévi-Strauss asserts that the sequences, or plot, of a myth are

only its apparent content, and that the plot is organized according to a structure composed like a musical melody of superimposed and simultaneous schemata. As logical devices, these schemata are opposed to the sequences, and act like a coordinate system to the sensibilities of a particular culture. Schemata may be geographical, cosmological, sociological or economic and are the productive components of meaning in a myth.¹⁶

There is, in Lévi-Strauss's view, no compelling reason to distinguish between myths and tales. However, there are some differences between the two genres.¹⁷ Legends and tales are based on different schemata from myths; instead of having cosmological, natural or metaphysical oppositions they tend to rely on moral, social or local oppositions. Furthermore, tales are less constrained by the dictates of logical coherence, religious orthodoxy and social coercion. Thus, tales and legends are structurally loose and the oppositions they use are more difficult to identify.¹⁸

Legends, like myths, are a means by which society attempts to answer fundamental questions, though these questions are seldom clearly defined. Legends of fabulous and grandiose architecture should then be considered as portraits of the social answers to questions about architecture. The legend of Sinimmār is clearly one of the answers to the problem of the origin of architecture, and the definition of the figure of the architect and his relation to the ruler in Arabian society. Early literature, dating from the end of the eighth century, contains many more references to grandiose south Arabian architecture, and these similar legends provide other answers to the same problems and help define the social function of architecture and its broader meaning.

Marvellous Beauty, Jealousy, Secrecy

The figure of Sinimmār, the architect who built the famous palace of al-Khawarnaq in the city of al-Ḥīra for the Lakhmid king, Annu'mān, is mentioned in many poems. Some sources say that Sinimmār was a Byzantine. The mythical architect was killed by his patron at the end of the construction and his fate was recorded in a famous poem.

Al-Jāhīz recounts a version of this story in *Kitāb al-Ḥayawān* (The Book of Animals). It is entitled 'The Tale of Sinimmār', and is

quoted at length above. According to al-Jāḥiẓ's account, the facts presented in the story are as follows:

- Sinimmār was a Byzantine architect.
- Sinimmār built a palace called al-Khawarnaq for a king.
- The palace was admirably magnificent.
- The king was excessively jealous and did not want Sinimmār to build a similarly magnificent palace for another king and therefore he had him thrown from the top of the palace.

Thus, we learn from al-Jāḥiẓ that Sinimmār was, indeed, of Byzantine origin and that he was killed on account of the king's vanity and fear that someone else might commission a palace of equal beauty. Somewhat later in the text al-Jāḥiẓ points out that the Arabs borrowed architecture from the Persians, for whom it served as a means of social differentiation.¹⁹ As the killing of Sinimmār was apparently due both to the king's fear that the architect might construct palaces of comparable beauty for other princes, and to his desire to distinguish himself by possessing such a great building, this violent outcome can naturally be related to the theme of architecture as a means of social segregation and distinction that could lead to extreme consequences. It is also remarkable that on the one hand al-Jāḥiẓ asserts that the practice of architectural symbolism was copied from the Persians, while on the other hand he reports that the architect of al-Khawarnaq was a Byzantine. This is a paradox, but a meaningful one, for it points to the two recognized roots of Arabian architecture and to the documented Sasanian use of Roman architectural elements.²⁰

Tabari gives another version of the story of Sinimmār:

It is said that al-Khawarnaq was built because Yazdagird III was granted a son, after he had been waiting for a long time, and enquired where a healthy place would be for the child to be raised. He was told that the surroundings of al-Ḥīra were the place he was looking for. He then sent his son to Annu'mān to take care of his education, and ordered him to build al-Khawarnaq for his sojourn. The child was then

settled there, and in addition he [the king] had the opportunity to visit the hinterland of the Arabs. Al-Khawarnaq was built by a man called Sinimmār. When the works were completed, the building was saluted with great admiration [in the court of Annu'mān]. Sinimmār then said: 'had I known that you were going to pay my salary, and to pay me all the respect I deserve, I would have built a building that turns with the sun wherever the sun turns.' Annu'mān answered: 'How did you dare not to build it that way, since you claim to be able to!' And he ordered him to be thrown from the roof of the building. Sinimmār was thus thrown from the roof of al-Khawarnaq.²¹

Although Tabari's and al-Jāḥiẓ's accounts report the same event, and lead to the same apparent conclusion, there are clear discrepancies between the two. Whereas al-Jāḥiẓ announces the killing of Sinimmār at the outset, Tabari begins his narrative with a scene in the Sasanian court, an introductory move explaining the original motivation for the building.

Diversity and changes in the narrative of legends are common. Change can be related to local cultural specificities, or to the historical evolution of perceptions. In terms of the narrative, legends are composed of different sequences, or moves, which may vary in number and quality. They set out different statements containing variables and invariables, which we can compare against different versions.

In a corpus of legends the *dramatis personae* may change without affecting the basic content of the legend. It is not the *dramatis personae* themselves who are important, but rather the function they represent. Furthermore, identical events and actions may be interpreted in vastly different ways according to the emphasis of the legend. Therefore, it is only by placing each event and character in its context and by studying the entirety of the corpus that the meaning of a legend can be correctly apprehended.²² The statements in each account are simple and there are limited variations of the same type in which the author's preferences and the constraints of his epoch play an important

role. The essential meaning of the legend is then defined as the sum of invariables they all share. Consequently, the variable elements will be regarded as signifying changes in attitudes towards the problems the legend raises.

The structural analysis of narrative as Roland Barthes defines it is very similar to Lévi-Strauss's framework for understanding mythology.²³ Barthes distinguishes two levels of production of meaning in narration. The first level is denotation or explicit meaning. The second is connotation, defined as the intrinsic ability of discourse to produce meaning independent of the conscious intention of the speaker. It occasions meanings that are unintentional, but that may be more expressive of the type of thinking that produces the declared message.²⁴ This means that to understand the meaning of a legend fully one should not limit one's analysis to the apparent information it carries or to its moralizing intention. Rather, one should go beyond the explicit and intentional and try to ascertain what the legend reveals about the type of thought that produced it in the first place. Denotation and connotation are thus two important levels of meaning to consider in analysing a legend. In this respect each legend is comparable to a piece of a puzzle, and it is therefore important to underline that to understand its meaning most fully, a legend should not be read by itself but rather in relation to other legends. It is the way it fits in this puzzle that ultimately reveals its importance.²⁵

How can this theory of myth inform our reading of the legend of Sinimmār? A preliminary remark ought to be made, which is that Tabari does not tell us the origin of Sinimmār. This is worth noting because Tabari usually pays meticulous attention to details, and often gives several versions of the same story. Therefore, one might conclude that he was either uncertain about the origin of Sinimmār, or that he considered it irrelevant. Tabari's account thus shows an important lacuna. For, by asserting that Sinimmār was Byzantine, one makes an important statement about the origin of architecture and its meaning. Indeed, in Persia, as reported by al-Jāhīz, architecture was used as a vehicle of social distinction; and in the Byzantine Empire, it was used, by contrast, for purposes of propaganda by the Church.

It should be recalled that the Lakhmid kingdom, of which the capital was al-Ḥīra, was a buffer state the Sasanians created on the frontier with the Byzantine Empire. The Lakhmid kingdom collapsed in CE 602, a few years before the Islamic conquest of Persia. The city of al-Ḥīra fell to the Muslim armies in CE 633, and was abandoned in the eighth century CE.

I shall represent the contrasts between the accounts of al-Jāḥiẓ and Tabari as follows:

- al-Khawarnaq was built to provide the miraculously born son of the Sasanian emperor with a healthy place in which to live.

This could be read as suggesting that the project of al-Khawarnaq was inspired by the Sasanian king of kings, the suzerain of the Arab king of al-Ḥīra, and not the Arab vassal. The palace was conceived for the child of the Sasanian master, the future Buhram Gur, and not for Annu'mān himself. It was meant to enhance the image of the Persian master and not that of the Arab king. Accordingly, al-Jāḥiẓ's statement about the introduction of architectural symbolism into Arab society as a means of commemoration borrowed from the Persians becomes questionable, for it would appear that this was not a voluntary borrowing by the Arabs, but the imposed construction on Arab soil for a foreign prince.

- The Arab vassal took care of the education of the heir to the throne of the Sasanian Empire.

The placement of the future suzerain under the supervision of the Arab king somewhat reverses the status of vassal and master, for a pupil is always under the authority of his tutor. The Arab vassal simultaneously recognizes the young Sasanian as his suzerain and acts as protector and, hence, master of the future suzerain. The vassal is thus master of his own future master. This paradox makes vassal status a cyclic and reciprocal relationship, and therefore not a humiliating one. This perspective is more congruous with Arabian pride, which, incidentally, was 'grounded'

in nature itself, since the Arab countryside was the healthiest the Sasanian emperor could find for nurturing his son.

- Al-Khawarnaq was built by a man called Sinimmār.
- The palace was saluted with great admiration.
- Sinimmār made an offensive remark, for which he was punished (thrown from the top of the palace).

According to Tabari's account, it was not his patron's jealousy that caused Sinimmār's death, which was a legitimate reaction to a *lèse majesté*, but rather the insulting remark that the architect made. Sinimmār was in fact sentenced to death because he insolently questioned the king's honesty and failed to build the most marvellous palace he was capable of building.

By omitting any mention of the injustice of the reward, Tabari's version constructs a morally acceptable story. Hence, it fails to conform to the myth of Sinimmār celebrated in poetry. Nevertheless, the theme of marvellous beauty – and its connection to grandeur and the power and self-glorification of the king – is still invoked by Tabari, thus marking continuity with al-Jāhiz's account.

Kitāb al-Aghāni's account

Kitāb al-Aghāni (The Book of Songs) by al-Asfahāni, also contains an account of the death of Sinimmār. The account is similar in all details to Tabari's. Yet, al-Asfahāni also provides a second version of the story. It is brief, but particularly significant:

He says: and in some legends Sinimmār said to the king: I do know that this palace contains a weak spot, and if that spot is destroyed the entire building will collapse. So he [the king] answered him: by God you will never show it to anyone. And Sinimmār was thrown from the top of the palace.²⁶

This legend gives a completely different explanation for the behaviour of the king. In this version *Kitāb al-Aghāni* reaffirms the first four statements of Tabari's and adds new ones.

A systematic comparison of the statements made in each account can be displayed as follows:

The statements made in al-Jāhiz's account are:

- Sinimmār was a Byzantine architect.
- Sinimmār built a palace called al-Khawarnaq for a king.
- The palace was admirably magnificent.
- The king was excessively jealous, and did not want Sinimmār to build a similarly magnificent palace for another king and therefore had him thrown from the top of the palace.

The statements made in Tabari's account are:

- Al-Khawarnaq was built to provide the miraculously born son of the Sasanian emperor with a healthy place to live.
- The Arab vassal took care of the education of the heir to the throne of the Sasanian Empire.
- Al-Khawarnaq was built by a man called Sinimmār.
- The palace was saluted with great admiration.
- Sinimmār made an insulting statement for which he was thrown from the top of the palace.

In al-Asfahāni's first version, the two sets of statements are similar, but in the second version there are the additions of:

- Sinimmār reveals to the king the existence of a weak spot in the building that could allow its destruction.
- The king wisely does not take any chances and Sinimmār is thrown from the top of the palace.

In this second version recounted by al-Asfahāni it is neither jealousy nor insult that compels the king to have Sinimmār thrown from the roof. Rather, it is a necessary precaution for the preservation of the palace and his own life. In this new version of the story, the behaviour of the king cannot be considered immoral in the least. Indeed, it is Sinimmār who can be charged with

perfidious behaviour. Al-Asfahāni does not seem to give preference to one version over the other.²⁷

It is worth noting that al-Asfahāni fails to mention Sinimmār's origin. While al-Asfahāni is the most recent of our authors, he is Persian and because of that may have preferred not to mention that al-Khawarnaq was built for a Sasanian prince by a Byzantine architect. The revival of national pride in the Islamic Persian sphere might help explain this omission.

Prose/Poetry

Whatever the interpretation of the differences between the accounts of al-Jāḥiẓ, Tabari and al-Asfahāni, there remains an oddity in the reports, or at least in the moralistic versions. All accounts quote the poem about Sinimmār in a surprisingly consistent fashion, even when it undermines their arguments. Two accounts quote only parts of the poem; Tabari quotes ten verses, while al-Jāḥiẓ quotes five, and al-Asfahāni quotes only two. The two verses al-Asfahāni quoted are:

He rewarded me badly, may God reward him back
the reward of Sinimmār who had committed no sin
Except erecting a building for twenty years
topped by vaults of lead and tiles.

The other authors reported the same verses with the single change of one word in al-Jāḥiẓ's version – 70 years instead of 20. This change does not affect the content of the report: the exaggeration of years offers a more impressive image of the building, a very lengthy life for the architect and king, and makes the narrative more fitting to the mythical genre. But Sinimmār's presumed innocence, and the resulting immorality of the reward he received from the king, is explicitly stated in the two verses.

Consequently, al-Jāḥiẓ's account is factually congruous with the poem, but Tabari's is in contradiction with the poem, which he remarkably quotes at length. Al-Asfahāni, who quotes only these two verses, does not, however, avoid the contradiction. And, despite recording two versions, with two different motives

for the death sentence, both versions contradict the verses he cites.

If poetry is the first and last reference of truth in the mythical genre, is it not remarkable that two brilliant authors, such as Tabari and al-Asfahāni, chose to cite a poem in open contradiction with their main argument? This contradiction is, perhaps, the best argument in favour of al-Jāhiz's version and the hypothesis that later versions sought to moralize the legend of Sinimmār. It also indicates that poetry shows a stronger resistance to modification than prose, at least in a society that has a religious admiration for poetry.

The Disappearance of the King

The legend of al-Khawarnaq is not circumscribed by the theme of the death of Sinimmār. Another theme – the renunciation of power by a king – is also of notable importance in narratives about the majestic palace.

It is also the same marvellous beauty of al-Khawarnaq that weaves the story of the strange renunciation of power and of the disappearance of Annu'mān, the vassal prince of al-Ḥīra. Yaqubi writes:

And Annu'mān took power. It is he who built al-Khawarnaq. While he was seated looking from there towards the Euphrates, contemplating the palm trees, the gardens and all the trees, he thought of death. Then he thought: how can all this be useful when death comes down on you and you have to leave the world? He then led a cloistered life, and surrendered his power. The poet 'Addiy Ibn Zaid says of him:

Remember the lord of al-Khawarnaq, one day
 he looked out from his balcony, redemption has its own
 reason
 He was delighted by his state and his possessions
 and the breathing sea, and the dazzling Sadir
 His heart was bewildered, he thought: what felicity
 can a living being have when his path leads him to death?²⁸

In this account there is mention neither of a Sasanian prince nor of an architect. The entire narrative is about Annu'mān, his meditation and resulting withdrawal. These events are as famous as al-Khawarnaq itself. The building is mentioned in passing, while the core of the story is the moral it conveys – the realization of the emptiness of material wealth.

The statements Yaqubi made in this account may be presented as follows:

- An Arab king built a palace called al-Khawarnaq.
- The thought of death made him aware of the emptiness of the worldly magnificence of his palace.
- That awareness made him surrender his power and lead a cloistered, pious life.

Tabari also reports the story of Annu'mān's resignation. In fact his account of the killing of Sinimmār continues as follows:

We were told – and God knows best – that one day he [Annu'mān] sat down in his audience hall in the al-Khawarnaq, and from there he contemplated Annajaf, and all the other gardens, palm trees, and rivers to the Occident and the Euphrates to the Orient. ... It was in Spring, and he was so pleased by the vegetation, the flowers, and rivers he was contemplating that he said to his vizir and friend: 'have you ever seen something as beautiful as this view? The vizir answered: 'no, but if only it could last forever!' Annu'mān said: 'And what is it that lasts forever?' The vizir [said]: 'All that God has in the other world.' Annu'mān: 'And how can that be had'. The vizir [said]: 'By leaving this world, worshipping God and asking him mercy and grace'. Annu'mān surrendered his kingship on that very day, wore simple clothes, and left his palace by night, unseen as if fleeing. The next day, unaware of what had happened, people came to the palace, but they were not allowed to visit the king as they were accustomed to. After a while, they asked about him [the king] and they were told what

had happened. It was about him that the poet ‘Addiy bnu Zaid al ‘Ibadi said: ‘Remember the lord of al-Khawarnaq.’

He then quotes two more verses than Yaqubi:

And after victory, kingship and leadership
 following them there is the tomb
 And they end as if they were only dry leaves
 twisted by the winds.²⁹

Since Tabari presents the account of the disappearance of Annu‘mān as a continuation of the report on the building of al-Khawarnaq, the statements it makes should be considered as related and complementary to those about the building and the death of Sinimmār. The new statements are:

- A king, proud of the magnificence of his palace, started a discussion with his vizir about its vistas.
- The vizir persuaded the king that only the eternity of the other world is worth seeking.
- The king renounced his power for a life of simplicity and prayer (as indicated by the clothes he then wore) and vanished.
- People were informed of the disappearance of the king after asking about him.

In the first part of Tabari’s account, the Sasanian king of kings commands the construction of a majestic palace. The Arab vassal could not tolerate an insult from the architect, and sentences him to death. In the second part, Tabari makes Annu‘mān the landlord of al-Khawarnaq, and offers a conclusion that is completely unrelated to the story of the Persian royal infant. But the events are presented as if the author were trying to exculpate Annu‘mān by suggesting that the decision to sentence Sinimmār to death was, in fact, not his own. All that he did was involuntary, precisely because he was acting under constraint and reacting to a *lèse majesté*. Thus, the king’s legendary ingratitude was mitigated, if not simply denied. Later, Annu‘mān is described in his palace, not

in the palace of the Persian prince, contemplating marvellous views from his audience hall. It was the beauty of his view of nature, which is a divine creation, and not that of the palace, which is a human construction, that prompted a decisive discussion between the king and vizir and that led Annu'mān to renounce worldly pleasure in pursuit of a spiritual life. He renounced the ephemeral things of this world, for he sought only what lasts forever – what is not of this world. It is as if the legend was constructed only to disavow the pretence of architecture in its attempt to immortalize and bestow eternity.

Interestingly, the poem about the disappearance of Annu'mān mentions another building, Assadir, which indicates that al-Khawarnaq was not the only grandiose architectural work in al-Ḥīra that the Arabs celebrated. This evocation further suggests that references to a variety of grandiose buildings actually wove a large discursive fabric, and that the myths of fabulous buildings can be assumed to constitute a mythology of grandiose architecture.

Annu'mān's renunciation of worldly pleasure and sudden disappearance were as legendary as the fate of Sinimmār, his architect. Both were celebrated in poetry and both were used as moralizing figures – Sinimmār as the symbolic victim of ingratitude, and Annu'mān as the symbol of the renunciation of worldly goods and the discovery of truth and the immortal. But, even though they are historically connected in that Sinimmār was Annu'mān's victim, the legends do not appear to be tied to each other, except in a loose way in Tabari's account. Poems invoking Sinimmār do not mention Annu'mān and those invoking Annu'mān do not mention Sinimmār. Annu'mān's legendary renunciation was presented as a spontaneous and sudden revelation of the truth, and realization of the ephemeral nature of worldly beauty. In remaining two distinct legends, the stories preserve their mystical content. Indeed, if Sinimmār's murder had been mentioned in the legend of Annu'mān, it would imply that a sense of guilt had motivated the latter's complete transformation. Annu'mān would no longer reign as the legendary ruler who freely and wisely renounced worldly pleasure for spiritual truth.

It is of particular significance that al-Asfahāni introduced his

account of al-Khawarnaq with a narrative in which Khalid Ibn Safwān relates this very story to the Umayyad caliph Hisham Ibn 'Abd al-Malik.³⁰ By narrating the story of Annu'mān, Khalid seeks to advise the caliph, and dissuade him from dependence on power and wealth. The narrative is intended as a sermon, and the moral of the story about Annu'mān so moved the caliph that he showed his emotion publicly by crying shamelessly and at length before his assembled courtiers. He then secluded himself for long enough to concern his entourage, which could only blame the sermon giver. Here, we witness a near repetition of the story of Annu'mān.

Al-Jāhīz states explicitly that architecture fails to immortalize rulers and events because victorious kings often destroy the buildings of defeated enemies. Tabari turns this assertion into a parable. Yet, both authors point to the same conclusion, which may be summarized as follows: architecture is a fraud; it claims to offer something impossible that does not belong to this world.

Writing three centuries after al-Asfahāni's death (d. 356 AH), Ibn Athīr (d. 630 AH) once again relays the legend of Annu'mān. In his account, the story of Annu'mān becomes just a part of the story of the Sasanian emperor Yazdagird Dhu al-Aktaf. Annu'mān is described as a blood shedder who 'invaded Ash-sham many times, causing its population excessive harm'.³¹ The story of the construction of al-Khawarnaq follows the outline of Tabari's account. However, the tale of Annu'mān's vanishing immediately follows it. Ibn Athīr thus links the two events for the first time. Annu'mān is described as a murderous king who repents when his wise vizir convinces him of the emptiness of power and wealth. To avoid narrative inconsistencies, Ibn Athīr simply mentions the poems about Sinimmār, but does not quote them. The legend now focuses on Annu'mān's reign and transformation rather than on Sinimmār, who becomes an auxiliary figure. The moralizing work of Tabari has finally attained its goal; here, the legend has become an unambiguous parable of vanity and renunciation.

Shaddād and the Antiquities of South Arabia

The corpus of legends about grandiose architecture is relatively extensive and includes figures other than Annu'mān and

Sinimmār. However, myths with different characters do not necessarily convey different meanings. For instance, the story of ‘Umar Ibn ‘Abd al-‘Aziz’s conversion to Sufism, and the change of his once typical kingly attitude towards architecture to the adoption of an austere aesthetic, can be read as a version of Annu‘mān’s disappearance. Here, however, he neither renounced kingly power nor was accorded heroic status on account of his transformation. The difference is that he is a true caliph and not simply a vassal of a foreign power who believes he has enough power to implement reform.³² Rather, these legends seem to mirror each other and to convey similar messages about architecture. This similarity between different tales about grandiose architecture is predictable given the nature of mythology. Indeed, redundancy is a major characteristic of myths and legends. As Edmund R. Leach writes, ‘Each alternative version of a myth confirms ... and reinforces the essential meaning of all the others.’³³ This redundancy is also the foundational basis on which the multiform, picturesque and colourful character of tales stands.³⁴

Al-Iklil or *The Antiquities of South Arabia*, offers a rich and lively series of architectural legends. Among these is the story of Shaddād, whose architectural feats are described at length, as mentioned in *al-iklil*:

He said: Shaddād reached the Far East and defeated every opponent, and he went to the region of Samarkand in the land of Attubbat. Then he went to Armenia and came to al-Sham and then to the Maghrib until he reached the Atlantic Ocean. All along he built cities and palaces. He lived two hundred years in the Maghrib, and left to the Mashreq. He disdained going to Ghumdān and went to Mahāreb where he built the old palace of the gems that is called Iram of the pillars. He gathered all pearls, gems, carnelians, onyx, and *bārid bābil* of Yemen, and asked for more from abroad. He then gathered all the jewels of the world, the gold, the silver, the iron, the copper, and the lead. He built and decorated the palace with all those precious stones. He made the floor of glass, red, white and other colours and built underneath

conduits and tunnels in which he made flow the water of the dam, making a unique and unprecedented palace. Shaddād ibn 'Ād died when he was five hundred years old, and his chamber tomb was cut in the rock in Jabal Shamam. He was humble before God, and never bore a crown.³⁵

In contrast to al-Hamadhāni's description of Shaddād, certain other sources have depicted him as arrogant and impious. The story was reported by Tabari, among other commentators, and has been linked to the city of Iram in the following verse of Sura al-Fajr in the Qur'an:³⁶

Seest thou not
 How thy Lord dealt
 With the 'Ād (people),
 Of the (city of) Iram,
 With lofty pillars,
 The like of which
 Were not produced
 In all the land?

Commentators have identified the mythical city of Iram with Damascus as well as a lost city of Yemen.³⁷ In *The Muqaddimah*, Ibn Khaldun sums up the debate about the geographical location of Iram as follows:

The commentators consider the word Iram the name of a city which is described as having pillars, that is, columns. They report that 'Ād b. 'Us b. Iram had two sons, Shadīd and Shaddād, who ruled after him. Shadīd perished. Shaddād became the sole ruler of the realm, and the kings there submitted to his authority. When Shaddād heard a description of Paradise, he said: 'I shall build something like it.' And he built the city of Iram in the desert of Aden over a period of three hundred years. He himself lived nine hundred years. Iram is said to have been a large city, with castles of gold and silver and columns of emerald and

hyacinth, containing all kinds of trees and freely flowing rivers. When the construction of the city was completed, Shaddād went there with the people of his realm. But when he was the distance of only one day and night away from it, God sent a clamour from heaven, and all of them perished. This is reported by al-Tabari, al-Tha'ālibi, al-Zamakhshari, and other Qur'an Commentators. They transmit the following story on the authority of one of the men around Muhammad, 'Abdallah b. Qilabah. When he went out in search of some of his camels, he came upon the city and took away from it as much as he could carry. His story reached Mu'awiyah, who had him brought to him, and he told the story. Mu'awiyah sent for Ka'b al-Aḥbar and asked him about it. Ka'b said, 'It is Iram, that of the pillars.'³⁸

Ibn Khaldun also reports that others have identified Iram with Damascus and more mysterious places, and mentions all the 'crazy talk' that took place about it. Faithful to his rational approach, he comments: 'All these are assumptions that would better be termed nonsense.'³⁹ He further explains that all these 'fictitious fables' resulted from the misled assumption that the expression, 'that of the pillars' was an attribute of Iram, which was then grammatically narrowed down to mean some sort of building.

Ibn Khaldun's rationalist approach is interesting in the way he uses linguistic analysis to trace the fault line from which fables arise. But, despite its acuity, his analysis overlooks the crucial need for and meaning of fables. Al-Hamadhāni, who reports the first version of the story of Shaddād, also evokes Iram. He relays the story of the man who lost his camels and accidentally discovered Iram during the reign of Mu'awiya. He also mentions that the Persians identify it with Damascus, but comments no further; 'God is the most learned,' he concludes.⁴⁰

Previously, we saw how Tabari commenced the progressive moralization of the legend of Sinimmār, and how he was presumably unaware of the contradiction between the poem he quoted, and his narrative. It is not surprising, then, that Tabari

also reports a version of the story of Shaddād, describing him as an arrogant builder destroyed by God's will. It should be noted that Tabari's account was not reported as an ordinary profane narrative, but as *tafsīr*, an exegesis of the sacred book, the Qur'an. The other commentators have likewise proposed their versions as Qur'anic exegesis. These stories were thus reported in the most respected and pious works of their time.⁴¹ They were far from being considered fables; rather they were supported by the truth conferred by the authority of the commentators and their reference to the Qur'an.

What are the statements made by al-Hamadhāni in his account of Shaddād, and how do they compare with those made in other versions? In al-Hamadhāni's text, the following statements summarize the narrative of Shaddād:

- Shaddād is a son of 'Ād.
- Shaddād ruled a world empire from the Far East to the Atlantic Ocean but he was so humble before God that he never wore a crown.
- Shaddād built cities and palaces everywhere.
- Shaddād gathered all the gems of the world to build a unique and unprecedented palace called Iram in Mahāreb, Yemen.
- Shaddād lived 500 years (of which 200 were spent in the Maghrib).

This version unambiguously praises Shaddād and we can therefore refer to it as the eulogistic version. In contrast, the account reported by the commentators is highly critical. The statements in the version of the commentators can be presented as follows:

- Shaddād is a son of 'Ād.
- Shaddād ruled a world empire and was arrogant and impious.
- Shaddād built an imitation of Paradise on earth, a city of gold and gems, called Iram.
- When the city was completed, God destroyed Shaddād and his people.

- Shaddād lived 900 years, of which he spent 300 building Iram

If we compare the respective statements of the two versions, we can say there are important and minor differences and only one common statement. The significant differences are:

- Shaddād was a believer who died peacefully in the first version, and an unbeliever who brought the wrath of God upon his people in the second version.
- Iram was a palace in the first version, and a city in the second.
- Iram was a unique palace and only one of the many palaces and cities Shaddād built in the first version; it was a copy of Paradise and thus stood in defiance of God in the second version.

If legends are indeed a means by which a society attempts to answer fundamental questions, it can be said that the two versions of the story of Shaddād provide opposite visions of the origins and religious meaning of architecture. Al-Hamadhāni supports the idea that building, and even the most fabulous architectural works, are compatible with faith and humility, and are in a sense a sign of the blessing of God. The commentators espouse the opposite view, which is that grandiose architecture and luxurious decoration arrogantly claim to create Paradise on earth and, further, attempt to compete with the might of God, thereby defying him.

Both Tabari and al-Hamadhāni draw on older sources (eighth and ninth century). The chain of transmission of the story involves two famous personages of the early Islamic period – Mu‘awiya, the founder of the Umayyad caliphate, and Ka‘b al-Aḥbar, a Jewish convert of Yemeni origin. In Islamic literature from this period, the latter was considered an authority on antiquity, the Bible, and early Islam, and played an important role in the assimilation of Jewish traditions into Islamic culture.⁴² If this chain of transmission is to be trusted – and indeed there is no reason to reject it given the Yemeni origin of Ka‘b al-Aḥbar – then people living in Yemen in the early Islamic period must have known, and possibly celebrated, the story of Shaddād. That scholars have connected Mu‘awiya himself to the transmission of this story

strongly suggests that the caliph may have heard a version of it. It is also documented in early Islamic literature that Mu'awiya was known to invite the learned of his time to his court, and appreciated hearing tales of old kingdoms.⁴³ It would then be reasonable to assume that stories like that of Shaddād and other tales about ancient Arabian kingdoms were narrated in his presence. Because some of these stories were mentioned in the Qur'an, their discussion would have been considered a pious occupation related to exegesis. Thus, we can assume that different versions of the legend of Shaddād have existed since the early Islamic period, and that they were commonly narrated and discussed.

It is certainly not an accident that Tabari links Mu'awiya to the legend of Shaddād. For, in addition to being the founder of the first Arab Muslim dynasty and an individual who was fond of the history of ancient kingdoms, he is also believed to have been the first Muslim ruler to have used architectural elements, specifically a green dome, as a symbol of power.⁴⁴ Furthermore, it is his half brother – a governor in Iraq – Ziyād ibn Abīhi who is credited as the builder of the first splendid architectural work in the history of Islam, a *dar al-Imāra* in Kufa.

The two versions of this legend, eulogistic and critical, probably always coexisted and conveyed two contradictory visions of architecture. This should actually be considered symbolic of the basic ambivalence of Islamic society towards architecture. On the one hand, there is an important and continuous development of luxurious architectural works supported by a vision of architecture as a sign of the blessing of God; and on the other there is permanent criticism of architecture as displaying a lack of piety and impudently defying the might of God. Both views find support in the Qur'an. The Qur'an portrays architecture as a blessing bestowed on the 'Ād people who, God says, must be grateful and refrain from evil.

And remember how He
 Made you inheritors
 After the 'Ād people
 And gave you habitations

In the land: ye build
 For yourselves palaces and castles
 In (open) plains, and carve out
 Homes in the mountains;
 So bring to remembrance
 The benefits (ye have received)
 From God, and refrain
 From evil and mischief
 On the earth.⁴⁵

But the Qur'an also depicts architecture as a devious symbol of arrogance and lack of faith.

Do ye build a landmark
 On every high place
 To amuse yourselves?
 And do ye get for yourselves
 Fine buildings in the hope
 Of living there for ever?⁴⁶

It is remarkable that in the early twenty-first century poems narrating the legend of Shaddād are still popular in the oral tradition of southern Morocco, in the far west of the Arab world. The insistence of this theme and its diffusion indicate its basic role in the construction of Arab Islamic culture. The poet says:

O mindless! Look at Duniyā, countless generations passed on
 to the
 other World and disappeared ...
 Where is Shaddād who built every palace that his heart
 desired
 and spent each night with a beautiful eye
 Who raised towers with corals and pearls
 and made them shine with diamonds and gold
 And after that it all returned to nothingness.⁴⁷

Poems about other mythical figures of Arab culture express similar

messages in almost the same words. The book of al-Hamadhāni is full of poems of this genre relating to personages like Luqman, Dhu al-Qarnain and many pre-Islamic Arab kings. The following poem about Dhu al-Qarnain, which is very close in meaning and expression to the Moroccan poem about Shaddād, is reported in *al-Iklil*:

Where is that who reached all the orient
 and the western empty parts of earth
 And built on Yagog a dam and tightened it
 with aloes wood which strengthened it and remained
 invisible
 But when destiny fell on him
 he responded and disappeared leaving no trace in
 memory
 (or) as he never existed.⁴⁸

The theme and the imagery of great buildings and the inescapable fate of all human beings is a common trope in Arabic poetry and prose. As an 'Abbasid poet says:

Lidū lilmawti wa bnū lilkhārābi
fakullukum yasīru ilā tabābi.
 (Abu al-'Atāhiyah, CE 747/8–826)⁴⁹

Give birth for death and build for ruin
 (give birth in the vision of death and build in that of ruin)
 For you will all be destroyed.

It is also a topic commonly articulated today in the warning: '*bni wa 'alli wa sir wa khallī*', 'build high buildings, yet you will go and leave all'. However, this popular imagery does not represent a negative attitude toward building; it is primarily expressed as a warning against vanity. It should be recalled that among the sins of the people of 'Ād, the Qur'an mentions vanity and the illusion of building as a way to escape death:

And do ye get for yourselves

Fine buildings in the hope
Of living therein (for ever)?⁵⁰

One can seek fortune and wealth, yet one should never forget the inevitability of death, and therefore should also practise good deeds and piety so as to be prepared to face God on Judgment Day. Like in the myth, which is central not just to Arab but to all Islamic cultural forms, architecture is paradoxically perceived as at once a divine gift and an ill that misleads human beings (and civilizations) into an ultimately confusing state of oblivion from death, and the other world. Thus, I suggest that ambiguity, which is found not solely in the actual artistic forms but also in discourses, theology, mythology, and the language of collective memory, is a foundational component of architecture and the ways in which it is perceived.

We might also interpret the legend of the death of Sinimmār in relation to the understood role of the architectural planners in early Islamic history. At this point in time, it was customary for kings to claim the authorship of buildings, thereby denying architectural planners their role in the design. In this sense, we might view the death of Sinimmār as a symbolic return of the figure of the architectural planner to cultural memory. It would then be more related to an actual contemporary factual practice than to an earlier historical event. Of course, this interpretation does not contradict the others developed above. It coexists with them. Polysemy is inherent in legends, so multiple interpretations are appropriate for reading myths. Numerous interpretations and many layers of meaning should be sought to apprehend more fully the material at hand.

One should also underline that all the myths discussed here connect architecture to power and human vanity. None refers to a mystical view or connects architecture to an expression of chaos, order, or the unity of God. It seems, therefore, that most speculations about architecture as an expression of a mystical worldview have no historical basis in the early Islamic period.

5

Al-Jāḥiẓ in the Mosque at Damascus: Social Critique and Debate in the History of Umayyad Architecture

I saw the mosque of Damascus when one of the kings of the city gave me the opportunity to see it. One who sees it knows that no other mosque resembles it, and that the Byzantines have a great admiration for it. When ‘Umar Ibn ‘Abd al-‘Aziz became Caliph he clothed it and covered its walls with white draperies. He also boiled the chains of the chandeliers until they lost their glitter and their luster for he claimed that those objects contradict the Islamic Sunna, and that marvellous beauty and charming refinements lead hearts astray and disturb meditation, and no mind can rest and gather itself when there is a thing that scatters [its attention] and opposes its unity.

(Al-Jāḥiẓ)¹

Al-Jāḥiẓ’s account of the mosque at Damascus first prompted me to enquire whether a debate about the aesthetics of Umayyad architecture could have existed during the early Islamic period and, if so, what its terms might have been. In Chapters 2 and 3 I have discussed parallels between architecture and poetry, both in terms of structural functioning, and of their effects on the mind. I also described controversies about songs and music, and their

compatibility with faith, and suggested that the terms of these controversies were analogous to those about architecture.

In this chapter I discuss a variety of literary and historical sources that suggest that a debate about architectural aesthetics did in fact take place early in the eighth century, and that the semiotic quality of architecture was used not only by the caliphs to magnify their reign, but also by their opponents in their political struggles. In seeking to define this debate, I discuss, among other documents, poetry in the form of *hijā'* about the Umayyad monuments, and the discourse of accession to the throne by Yazid III, which, I argue, indicate that architecture was conceived of as a complex strategy of public expenditures, labour policy and spatial semiotics. Literary evidence reveals that architecture was not only a means of dynastic glorification available to rulers but was equally the symbolic topic of political battles, propaganda and political economy. These conscious political uses of building activity indicate that some form of debate about architecture must have existed, at least in the administrative circle of the caliph.

In discussing the processes by which the early Islamic community successfully created new forms of art that met its specific needs Oleg Grabar suggests that it is highly unlikely that these new forms were the result of an express theoretical reflection on artistic development. Grabar explains: 'The terms of contact between an aesthetic thought, however limited, and the practical decisions of the users or patrons are almost impossible to imagine. ... Therefore, the hypothesis of a collective consensus seems to me preferable.'² It would seem that the issue is less about the creative processes by which artists and architects, starting from rich artistic practices and techniques foreign to Islam, reached new solutions, than about the meaning of the new forms of art. Grabar's hypothesis explains how Umayyad art can be considered 'in part a continuation of past visual systems without a particular Islamic meaning'.³ He accordingly contrasts Umayyad art with that of the 'Abbasid period, which is supposed to have emerged out of the new Islamic civilization. According to this view, these changes would have occurred in the late eighth century, and no debate about art would have taken place before the tenth century.⁴

As I mentioned in the Introduction, most scholars have explained the development of art and architecture in Iraq on the basis of Sasanian elements by noting the opposition of the Christian world to Islam, and the lack of resistance to the Islamic expansion in Persia. Grabar, among others, compared this process with the formation of European Renaissance art and architecture following the rediscovery of ancient Roman and Greek remains. Moreover, Grabar even characterized the emergence of Umayyad art as a true renaissance of classical forms of art. He observes that the reuse of Roman architectural elements, such as columns and capitals, was a rule so well respected that it is not always easy for scholars of the art of the Islamic world to distinguish between pre-existing elements of buildings and those made by Muslims.

Yet, a serious question should be raised about the nature of the continuity of classical and Islamic times invoked. As Erwin Panofsky has pointed out, the 'discovery' and use of ancient ruins by artists of the Renaissance were indeed problematic. The ruins had been there for centuries, but only with the Renaissance did they become suddenly meaningful.⁵ After being ignored for centuries, artists began to view them as positive models, and rediscovered them as sources of inspiration. Panofsky suggests that this rediscovery had to do with a cultural change of attitude at the end of the Middle Ages that resulted from the formation of a new and articulate attitude towards the arts. I suggest that we should consider the possibility that an articulate attitude towards the arts, and towards classical artistic heritage, may have existed in the early Islamic period. I do not intend to suggest that Umayyad art represents a rediscovery of earlier Byzantine art, but that the new artistic syntax it exhibits should be understood as symbolic of a new attitude towards the arts – and this independently of who (be it artists or patrons) might have developed it. Yet, as literary evidence documenting the existence of such an articulate attitude is so scarce and scattered, it is not surprising that it has been constantly overlooked.

In this regard, the above passage by al-Jāḥiẓ is highly revealing. It points to the existence of a twofold, inherently contradictory, attitude towards architectural decoration during the caliphate of

‘Umar Ibn ‘Abd al-‘Aziz, in other words to an ambivalent attitude displayed in al-Jāhiz’s narrative account of the mosque at Damascus. On the one hand, the existence of a favourable view of adornment and decoration is implicit in al-Jāhiz’s description of the mosque, the beauty of which al-Jāhiz admired and praised more than a century after ‘Umar. Al-Jāhiz thus evoked the admiration of the Byzantines, themselves great masters of decoration and refinement, for the Umayyad monument. All Umayyad monuments, in this sense, stand as a testimony to the high value attributed to decoration in Umayyad and ‘Abbasid architecture. On the other hand, al-Jāhiz’s account documents the existence of an opposite attitude, based on the presumed effects of ornament and decoration on the minds or souls (*al-bāl*) of believers. Recounting how ‘Umar Ibn ‘Abd al-‘Aziz covered the decorated walls of the Damascus mosque with draperies, and planned to unadorn them and to boil the chandeliers to reduce their glitter, al-Jāhiz explains that, ‘marvellous beauty and charming refinements lead hearts astray and disturb meditation, and no mind can rest and gather itself when there is a thing that scatters [its attention] (*farraqa*) and opposes its unity.’ Decoration thus has a divisive effect on the unity of the soul and on its concentration on God’s ways, and for this reason it is condemned.

It is documented that ‘Umar customarily sought the advice of the ‘ulama, and it can be deduced that he consulted them in planning the ‘unadornment’ of the mosque at Damascus. In this sense, it is legitimate to assert that al-Jāhiz’s account evidences that a debate about architecture did take place during ‘Umar’s reign. The existence of such a debate challenges some of the established hypotheses about the formation of Umayyad and ‘Abbasid architecture and provides new fodder for a discussion of its meaning.

The common trend among scholars of the art of the Islamic world to frame all discussions of the early Islamic community’s attitude towards the arts in terms of the ban on representing living beings, has replaced and obfuscated any meaningful exploration of the more general attitudes towards the arts that may have existed during this period. I would like to contrast this

limited purview of an early 'Islamic aesthetics' with an analysis that stresses the political uses of architectural monuments by the Umayyad caliphs. The Dome of the Rock in Jerusalem, for instance, has been presented by Grabar as the symbolic appropriation of a conquered land and by Nasser Rabbat as symbolizing 'Abd al Malik's political aspirations.⁶ The political meanings attributed to the building presuppose not only a conscious attitude towards the arts, but also a sophisticated understanding of the effects of architecture on the beholder.

Painting and mosaics provide documentation supporting the existence of a conscious attitude towards the arts, as well as evidence of discussions about artistic themes between artists and patrons. As Grabar notes, the absence of human and animal figures in the mosaics of the Dome of the Rock and those of the mosque at Damascus, 'implies that the Muslim patrons imposed themes and manners of representation on the mosaicists, whatever their country of origin'.⁷ Many of the paintings of the Umayyad period can also be used to support this hypothesis. This is well-documented by the painting in Quṣayr 'Amra, 'The Six Kings', as it is impossible to imagine an artist depicting the caliph as master of the world to whom defeated non-Muslim rulers are paying tribute without the caliph having been informed of the subject matter and agreeing to it.⁸ Thus, it can be asserted with some certainty that, at least in the case of palace paintings, the Umayyads did, in certain instances, explore and dictate very precise artistic themes.

In this chapter I explore the implications of an early debate on architecture. Starting with al-Jāḥiẓ's account as my point of departure, I attempt to follow the line of interpretation it suggests in terms of a 'double' attitude towards architectural decoration. I verify al-Jāḥiẓ's account against other sources (Tabari, Yaqubi, Masūdi, Muqaddasi) and seek to reconstruct the elements of the debate. Finally, I endeavour to define the implications of the debate for the history of Umayyad and 'Abbasid architecture, with particular emphasis on the social content of architecture, its role in anti-Umayyad propaganda, and the evolution of architectural decoration and typologies of the mosque.

YAQUBI'S ACCOUNT

Yaqubi confirms al-Jāhīz's account of the debate about the unadornment of the mosque at Damascus. He states that: "Umar sent some people to the Mosque at Damascus to take from it the marble, mosaics and gold, saying: people are distracted from their prayer by gazing at them. But he was told that therein was a trap for the enemy, so he left it as it was."⁹ Clearly, Yaqubi exaggerates by replacing the simple intention of unadorned the mosque with the action of actually sending workers to do it. Moreover, some analysts have viewed ornament in mosque architecture as a tool for seducing the faithful to compete with Christian churches. However, 'Umar was told that the marble, mosaics and gold actually served to divert the attention of the enemy rather than lure the faithful. Furthermore, his account points to the same opposition between gazing and serenity – or, in other words, the incompatibility of decoration and meditation in a religious architectural structure. It is worth noting that neither of the above accounts refers to the representation of living things, a subject that most art historians consider of central importance to the early centuries of the Islamic period. At the same time, we can reasonably assume that a debate on the appropriateness of decoration in religious buildings took place as early as the time of 'Umar Ibn 'Abd al-'Aziz in the early eighth century, and that this issue deserves to be discussed and checked against all available documents.

MUQADDASI'S ACCOUNT

Scholars of art often cite a passage from Muqaddasi, a tenth-century Arab geographer, in discussions about the meaning of Umayyad architecture. The passage is part of his description of Damascus, and follows the story of the mosque. It reads:

Now one day I said, speaking to my father's brother, verily it was not well of the Caliph al-Walīd to have expended so much of the wealth of the Muslims on the mosque at Damascus. Had he expended the same on making roads, on caravanserais, and for the restoration of the frontier fortresses, it would have been more fitting and more

excellent of him. My uncle said: O my son, verily al-Walīd was right, and he was prompted to a worthy work. For he beheld Syria to be a country that had long been inhabited by the Christians, where they had beautiful churches, so enchantingly fair and so renowned for their splendour, as are the Church of the Holy Sepulchre and the Churches of Lydda and Edessa. So he sought to build for the Muslims a mosque that should prevent their regarding these others, and that should be one of the wonders of the world. Do you not see that when he looked on the greatness of the Dome of the Holy Sepulchre and its magnificence he feared it could dazzle the minds of the Muslims and hence he erected above the Rock, the Dome that is now there.¹⁰

The apparent topic of the discussion between Muqaddasi and his uncle is that the function of such buildings was to prevent Muslims being seduced by Christian architecture. Grabar supports this view by highlighting the Byzantine awareness of the emotional impact of music and the visual arts alike in their ability to convert barbarians. He also mentions the Byzantines' invitations to Arab captives to visit a church or the court during early Islamic times, and the expectation that their captives would convert to Christianity on the basis of the emotional impact of these buildings on the soul of the visitors. Muslim rulers must have thus sensed a danger of defection from Islam to Christianity, and this fear motivated them to erect the first Umayyad monument.¹¹

This interpretation is problematic on more than one level. First, it does not question an explanation that might emanate from a later period. Indeed, it is very possible that this concern was not contemporary to the construction of the mosque, but only took shape later in the debate and was then projected onto the past as a founding motive for the building. This is the case, for example, with reference to other motivations that can be imputed a posteriori to the building of the Dome of the Rock.

That there was such a debate about architecture and its persuasive powers is undeniable and may be supported by stories about 'Umar Ibn 'Abd al-'Aziz's position from Yaqubi, Tabari and

Muqaddasi. However, this leads to a second question: why would Muslims still choose to build in such an ornate style in regions where there were no Christian structures to compete with them? Regardless of the motives, Muqaddasi's account implies that there was a general assumption that art and architecture are capable of doing something to the observer. There was also a debate about architecture that centred on its social function/toll in terms of its cost and of taxing the people. Muqaddasi raises many other issues in his description of Damascus that prepare the way for a broader theoretical discussion of the meaning of both the mosque and its history. Furthermore, al-Walīd is reported to have built a mosque at al-Madīna in the same style, allegedly with the help of the Byzantine emperor and Byzantine masons. But, since there were neither Christians nor Christian churches to compete with Islam in seducing the mind of the local populace deep in Arabia, the question inevitably arises of why al-Walīd bothered to seek the help of the Byzantines. Why did he order a building of the same architectural style in a context where the motives for the use of that style did not exist and, consequently, take the risk of exposing himself to public criticism?

The Umayyads' political opponents bitterly criticized their extravagant expenditure on the construction of the Damascus mosque, and most people likely shared their perspective. Although studies of the political uses of architecture have analysed the spatial dimensions of power, they have thus far overlooked the ways in which these prestigious buildings became a burden on the population. Yet Yazid III made direct reference to this problem in his accession speech of CE 744:

O people, I promise you I will not put one stone on another, nor a brick on another. I will not rent a river, or amass money, and I will not give money to a wife or to a son [of mine]. I promise you not to use the money of one town in another one until the first town is well served, and its people are not in need. I promise I will never close my door before anyone, and will never allow the strong to devour the weak among you.¹²

His speech promises a moderate, fair and frugal expenditure policy. It was equally an obvious criticism of the public expenditures and financial policies of his predecessors.

Muqaddasi gives an astounding account of the cost of the mosque. He writes:

People say that al-Walīd brought together for its construction the best skills of Persia, India, the Maghrib, and the Byzantine territories. He spent the *kharaj*, land tax, of Ash-sham of seven years, and eighteen shiploads of gold and silver looted from Cyprus, plus the mosaics and devices offered to him by the Byzantine Emperor.¹³

Even though Muqaddasi's exaggeration of the cost of the mosque may be interpreted as a sign of its greatness in public perception, it also indicates a public contempt for those expenditures. That is what the author seems to be suggesting when he reports on 'Umar Ibn 'Abd al-'Aziz's project to reduce the mosque. 'People say that 'Umar Ibn 'Abd al-'Aziz wanted to reduce (*yanqasha*) the mosque [of Damascus] and to make of it something useful to the Muslims, but he was advised otherwise.' The Arabic text reads, '*an yanqasha al-jāmi'a wa yaj' alahu fi maṣālihi al-muslimīn ḥattā nādhārūhu fi dhālika.*'¹⁴ The verb *naqasha* may signify decrease, diminish, lessen, reduce, impair, prejudice or detract.¹⁵ However, in the context of Muqaddasi's text it is almost certain that the verb signifies 'to reduce' or 'to diminish'. *Lisān al-'Arab* also supports this interpretation, for *intaqasha* is defined as to take little by little from and is often used in connection with buildings.¹⁶ Thus, the intention ascribed to 'Umar was to reduce the mosque and sell the removed parts or use them for other ends.

It remains difficult to imagine how the project of reducing the building might have been conceived. Which parts were supposed to have been removed? Was the *saḥn* concerned or only the surrounding free space? We can draw two conclusions from Muqaddasi's account relevant to our analysis. First, it corroborates al-Jāhīz's and Yaqubi's accounts in that it, too, documents 'Umar's proposal to reduce the mosque. It also sheds light on a particular

conception of public space in Islamic societies that might help explain the evolution of the urban fabric of Muslim cities, and the imperative to fill all available spaces.

It is of particular interest to note that Muqaddasi does not present 'Umar's thought as irrational, which suggests that his vision corresponded to a more widely shared perspective that was to prevail later in shaping the urban landscape. It ultimately raises the theoretical question of the opposition of the formal requirements of public space to the dictates of uses and needs, and the partial conversion of public spaces into private ones, seen in the gradual occupation of public spaces, such as streets and public squares, by private shops and houses in Arab cities like Damascus.¹⁷

Muqaddasi explicitly mentions that people had criticized the Umayyads for their policies and behaviour, indicating that debates about architectural works were not limited to powerful people and scholars, but extended to a larger audience. He cites a poem, which we can suppose but without certainty is from Umayyad times, in which the mosque at Damascus takes a central place:

You, who are enquiring about our religions
 when you see the appearance of their clergy
 And the beauty of the objects of which they boast
 what they show is not their truth
 Their only pride is a mosque
 which is more than what they are worth
 When a neighbour seeks their help
 they would never grant him even a little fire
 Ferocious they are with their neighbours
 their enemies parade safely in their abodes.¹⁸

This is an anti-Umayyad propaganda poem that dates to the last Umayyad decades. It further confirms the hypothesis that a public debate about architecture, public buildings, and expenditure took place early in the eighth century. When considered in the context of this debate, Yazid III's promise not to erect any new buildings falls into logical order. That a caliph felt obligated to

make such a promise in his speech of accession suggests that the issue must have been extremely important to his political agenda of opposition to the Umayyads.

For the Arabs poetry was a most effective vehicle for propaganda and for tackling sensitive issues. The poem cited above belongs to a genre called *al-hijā'*, a satirical form traditionally meant to mock, ridicule and defame. Historically, each Arab tribe had a poet of its own who would chant its merits and deride its enemies. Poets were usually feared by the tribal chiefs, who often had to buy their praise and silence their criticism. The factional politics of the new Muslim empire continued to use poetry in both its praising and defamatory genres. The traditional haranguing in the seasonal festivals had been partly replaced by poetry sessions in the court, and satirical poems defaming the rulers could circulate easily among their opponents.

Despite its defamatory aims, or perhaps because of those aims, the poem acknowledges the beauty of the mosque and even defines it as an object of pride that is beyond what the Umayyads are worth. From a structural point of view, the poem introduces three agents – the Umayyads, their neighbours and their enemies. It also presents three objects – a material object (a building) and two moral objects (pride and hospitality). The poem plays on an inverse symmetry between the enemies and the neighbours: while the enemies parade safely, their neighbours are in dire want. Each group receives from the Umayyads the opposite of what, morally and logically, it ought to be given. The neighbours, instead of receiving help and support, receive nothing. The enemies, instead of being humbled, are safely parading as they receive undeserved support.

A similar anomaly relates to the depiction of the Umayyads: although they claim the beauty of the mosque as their pride, this beauty is meant to conceal their more sinister reality. Indeed, the poem refers to an opposition between inner qualities and appearance: the beauty of the mosque does not reflect any quality of the Umayyads (who chose to squander all the financial resources of the empire on conspicuous buildings, but failed to show any hospitality), for the mosque is 'more than what they are worth'. One should recall that architecture is viewed as a codified lan-

guage that can reflect on its users, and certain architectural elements can reflect the nobility of the owners of the buildings. But the Umayyads are denied this use of architecture for they are not as noble as the buildings they have erected. They are not worthy of the mosque at Damascus, both because they deny help to their neighbours and because they use public funds to subsidize their buildings.

The perception of architecture as a royal deed was widely spread throughout the Arab world; a famous poem states:

These are our works, and they declare us,
wherefore, after we are gone, look at our works.¹⁹

That the caliphs destroyed all the monuments of their political enemies is a demonstration of their belief that architectural works reflect the greatness of their commissioners. Al-Jāḥiẓ explains that Muslim rulers adopted the pre-Islamic Persian custom of destroying their foes' palaces and fortresses (see Chapter 2). Thus, it is said that Caliph ʿUthman destroyed the tower and palaces at Ghumdān; that Ziyād, the illegitimate brother of Muʿawiya, destroyed the palace and caravanserai of Ibn ʿĀmir; and that the ʿAbbasids destroyed the works of the Umayyads in Syria-Palestine.²⁰ Al-Jāḥiẓ also reports that architecture fulfilled the same function for the Persians that poetry fulfilled for the Arabs – it immortalized its author and/or his accomplishments, which is the main reason why it is targeted for destruction.

Furthermore, in Persia good architecture and noble buildings, like noble names, were the exclusive property of the nobility. Thus, green cupolas, baths and balconies were architectural elements reserved for noble houses and palaces. The Arabs, who were well aware of this even before Islamic times, kept the use of poetry for themselves and appropriated architecture as well. Architecture thus becomes a language similar to that of poetry, for it can be used to immortalize a person or deed, even if it is less enduring in that it can be destroyed by enemies.

As a medium of *al-bayān*, rulers also use architecture to mark social segregation, and thereby enhance the status of the wealthy

class. It is precisely within this idiom that the Umayyads understood and used architecture. Their palaces in Damascus, and those of their governors, such as Ziyād Ibn Abīhi in al-Kufa, or al-Ḥajjāj, were evidently meant to highlight their social privilege and superiority.²¹ Conversely, however, political enemies could evoke these very qualities of Umayyad buildings in their propaganda against a particular ruler, or even an entire dynasty. This capacity is illustrated in the above-mentioned poem in which the high quality of Umayyad architecture is opposed to the Umayyads' vile behaviour, and ultimately used to criticize them.

ARCHITECTURE AND HOSPITALITY

Let us return to the propaganda poem about the Umayyad mosque in Damascus. Its main argument is that the Umayyads presented a brilliant appearance by means of the mosque, but lacked the requisite hospitality – a sacred duty among Arabs. This juxtaposition outlined in the poem between the grandeur of buildings and the hospitality of the people points to the common perception at the time that elaborate building projects implied unjustified or irresponsible public expenditures. In fact, a building as a physical object cannot, as such, oppose a moral attitude. However, the public saw the allocation of significant public funds for the construction of the mosque at Damascus as representing the caliph's preference for one building project over any other social policy. Thus, the caliph's decision can be construed as a moral attitude. Indeed, any public expenditure, and any project paid for by public money, testifies to a particular social conception, and may therefore be perceived as a moral – or immoral – deed.

The Umayyads also built other important mosques, in particular, those in al-Madīna and Jerusalem. It is therefore surprising that Muqaddasi did not report any public criticism of these other architectural structures. 'Umar Ibn 'Abd al-'Aziz did face some criticism when he started to destroy the rooms of the prophet's wives; in turn, 'Umar ensured the death of his critic, Qubayb. Yet, as I shall discuss below, Qubayb did not criticize 'Umar for the building's style or decoration. Rather, he criticized the decision to destroy the rooms that belonged to the prophet's wives.

It seems that, in contrast to the mosque at Damascus, there are no known or enduring critiques of the mosques in al-Madīna and Jerusalem. Muqaddasi, in his account of Jerusalem, describes the mosque as the largest and most beautiful, but does not mention any public argument or criticism. The question of why the mosque at Damascus received special critical attention can be answered by examining the differences between the mosques themselves. This critical attention did not result from any formal difference, as the mosques were of the same architectural style – even if they belonged to two different types. Rather, it was the particular character of the social and political context in Damascus that gave birth to this critique. Damascus was the setting of the royal Umayyad palace, and the mosque appeared as a component of the ensemble. The other mosques, far from the capital, were free of any such association.²²

On the other hand, the mosque at al-Madīna, being the Masjid of the Prophet, had a special symbolic religious meaning, and the one in Jerusalem very rapidly acquired its own religious significance as the third sacred Masjid of Islam.²³ Thus, the two mosques at al-Madīna and Jerusalem carried such symbolic significance that the public did not scrutinize or question the expenditures entailed. On the other hand, the mosque at Damascus was identified purely with the palace and caliph, and it therefore was viewed with reference to its political rather than spiritual and historical context. It is not accidental that many centuries after its construction, Ibn Khaldun called the mosque *Bulāṭ al-Walīd*, or ‘al-Walīd’s palace’.²⁴

Accounts of the Mosque at al-Madīna²⁵

Yaqubi and Tabari each provide a detailed account of the construction of the mosque in al-Madīna. In both narratives, ‘Umar Ibn ‘Abd al-‘Aziz was made Wali (governor) of al-Madīna in 87 AH and 30 camels transported his luggage. He assumed his tasks with enthusiasm and when al-Walīd decided to conscript soldiers among the people of al-Madīna, ‘Umar recruited 2000 men. It was also under his supervision that the mosque of al-Madīna was rebuilt. Here is how Yaqubi describes the event:

When al-Walīd built the mosque of Damascus he spent great sums of money; he started the works in 88 Hijra. After that he wrote to ‘Umar Ibn ‘Abd al-‘Aziz and ordered him to destroy the mosque of the Messenger of God, and to add to it the houses around it, and the rooms of the wives of the Prophet as well. Then he [‘Umar] destroyed the rooms and added them to the mosque. When he started destroying the rooms Qubayb Ibn ‘Abd Allah Ibn Azzubayr went to him and, while the rooms were being destroyed, said: how in the name of God can you, oh ‘Umar efface one of the verses of the Qur’an? Don’t you know that God says: ‘those who call you from behind the rooms’; ‘Umar then arrested him and sentenced him to one hundred lashes. After the lashes, Qubayb was aspersed with cold water and died. It was a cold day. Later when ‘Umar was enthroned Caliph and became pious, he used to lament: O my Lord, what pardon can I hope for after what I did to Qubayb?²⁶

Tabari also confirms the events and date (88 AH), as well as al-Walīd’s order to destroy the prophet’s mosque and his wives’ rooms, and to add this land to the new mosque. Tabari quotes Muhammad Ibn Ja‘far Ibn Wardān, a mason who claims to have seen Ibn ‘Abd al-Malik, al-Walīd’s messenger to ‘Umar II. According to the witness the message was:

To add the rooms of the wives of the prophet to the mosque, and to buy what was behind the mosque and around it, making the building one hundred by one hundred cubits. And he also said: push forward the *qibla* if you can. If possible, up to your uncles’ place, for they will not oppose you. And if someone refuses, ask some respected men to make a just appraisal of the house you need, and destroy it. Then give them their money. Be aware that you are not acting without precedent, for you have that of ‘Umar and ‘Uthman.²⁷

A second source quoted by Tabari states:

We started by destroying the mosque of the Prophet, *Ṣalla Allāhu ‘alayhi wa sallama*, in Safar 88 Hijra. Al-Walīd sent a message to the Byzantine Emperor to inform him that he ordered the destruction of the mosque of the prophet, and to ask for help. The latter responded positively, and sent to the Caliph one hundred thousand miskal gold, and one hundred labourers, and forty loads of mosaic cubes. He ordered the mosaics of ruined cities to be reprocessed and sent them to al-Walīd, who sent them to ‘Umar Ibn ‘Abd al-‘Aziz.²⁸

Marguerite Gautier-van Berchem has rightly questioned the veracity of this account. She explains, ‘Tabari states that he, the head of the Greeks, “gave orders for mosaics to be sought in the towns which had been laid in ruins”. The Byzantine Emperor could hardly do this in a country no longer in his possession.’²⁹ Yet, the anonymous account that Tabari reported nevertheless reflects the prevalent attitude towards Umayyad architecture. Moreover, there is a ‘slip of the pen’ in Tabari’s story. Indeed, he states that al-Walīd informed the Byzantine emperor of *the destruction of the mosque and he asked his help for that purpose*. Yet, Tabari did not mention the new building being planned, only the destruction of the existing one. The reader can extrapolate that al-Walīd requested help in the planning and construction of the new building, but could do so only after reading the rest of the story. It is as if the Byzantines’ help was somehow inappropriate in the context of the construction of a place of worship, and the Muslims should have been able to draw upon their own money and resources.

Even if the Byzantine emperor responded positively to al-Walīd’s request, the very act of asking Christians for help is, in a certain sense, a sign of the Muslims’ failure to show gratitude to God for all the wealth He bestowed upon them. Is it not defamatory to be offered reprocessed mosaic cubes for the mosque of the Prophet? There is certainly an implied critique of al-Walīd’s request in Tabari’s narrative. As a rule, a Muslim is not supposed to ask a Christian for help in building a mosque, for a mosque is *bayt Allah*, a house of God. If one is to present a gift to God he must do so by his own means.³⁰

It is also interesting to consider the issue of a legal precedent evoked in Tabari's account. Given the caliph's concern for a precedent with which to justify the expropriation of land for the extension of the mosque, we can deduce that such an acquisition represented a palpable concern in the politics of building. The case of the mosque at Damascus, in which a church was expropriated, despite prior agreements between the Christian community and the Muslim ruler, is well known. However, this does not represent the Muslim ruler's inability to respect his commitments. Rather, the need for suitable urban land shaped the politics of expropriation. As al-Walīd states in his message to 'Umar, the expropriation of land for the building of religious architectural structures has a history of its own, a history that was first implemented against the interests of Muslim private individuals. It is a history of building, power, authority and violence.

Extensions of the Masjid al-Ḥarām

Extensions of the Masjid al-Ḥarām at Mecca occurred early in the Islamic period, for the pilgrimage ceremonials occasioned the gathering of huge masses. Thus, as early as the year 17 AH – soon after the end of the First Fitna, that of the great Riddah war, and the accession of 'Umar Ibn al-Khattab to the caliphate – the need for a larger space in which to accommodate the annual religious gatherings of the ḥajj in Mecca was strong enough to initiate a process of continued extensions. It should be recalled that the first caliphate – that of Abu-Bakr – represented a kind of 'emergency status'³¹ during which the foremost concern was regaining the allegiance of those Arab tribes that had rescinded from the Muslim community following the prophet's death. Abu-Bakr's rule was thus entirely devoted to the Riddah wars.

'Umar, the second caliph, was the first to organize the Muslim community around the creation of new institutions – which he achieved primarily through the institution of an army *diwan*, a registry of all Muslim soldiers. 'Umar distributed the booty from the army's conquests among the men (as well as some women) listed in the *diwan*, and this money constituted an important financial resource in the cohesion of the Muslim community.

Although many questions regarding the practice and obligations of Islam remained unanswered at this point in history, 'Umar's authority was predicated on religion, and he therefore had to define clear and common standards for everyone. Consequently, the Muslim tradition credits him with defining and tightening many duties, such as imposing the ḥajj, the pilgrimage to Mecca, as an obligation.

Therefore, it is no surprise that 'Umar had to enlarge the Masjid al-Ḥarām. Tabari reports:

And in that year – I mean the 17th of al-Hijra – 'Umar [Ibn al-Khattab] went to the 'Umra and built al-Masjid al-Ḥarām – that is what al-Waqidi says – and he extended it. He remained twenty nights in Mecca, destroyed the buildings of those who refused to sell, and put their money in the *bayt al-māl* [public treasury] where it remained until they took it.³²

We can draw some interesting conclusions from this event. First, despite the religious purpose of the extensions and the evident exclusive need for their land, some owners did refuse to sell. It is possible that the people of Mecca were generally less devout than one might think as they had, for the most part, been forced to convert to Islam. In fact, most of the Meccans, like the many tribes who returned to Riddah after the death of the prophet, had embraced Islam as an allegiance to the prophet himself, and thus felt free of any Islamic obligations after his death.

The second conclusion, which is more relevant to our concern, is that the refusal of some landholders to sell their homes did not stop the caliph from demolishing them. This is the same legendary caliph who, during a tour of Jerusalem after signing the treaty of capitulation by the Christians, hurriedly exited the church he was visiting when he realized it was time for the afternoon prayer. He then made his prayer on the parvis, the portico in front of the church. When the bishop, who was accompanying him, asked him why he did not remain in the church for his prayer, he replied that he did not want his people to take advantage of his act to take over the church. Thus, the same ruler who destroyed Muslim homes

against the will of their owners was careful to avoid setting a precedent in order to preserve a Christian church. 'Umar clearly did not conceive of this inconsistency as a discriminatory act. It was simply demonstrative of his polished sense for what constituted a *raison d'état*. 'Umar understood that to extend the Masjid al-Ḥarām, it was necessary to confiscate Muslim houses in Mecca. And it was the same *raison d'état* that later forced al-Walīd to expropriate the Christian churches to build the mosque at Damascus.

In 26 AH, only nine years after the works of 'Umar, 'Uthman, his successor, was compelled to expand the Masjid al-Ḥarām even further due to the increase in the Muslim population. In the same year, 'Uthman both constructed his house, and extended the Masjid of the Prophet at al-Madīna, using stones brought from Batn Nakhil, and lead to strengthen the pillars.³³ Tabari's account reads:

It is said: in that year 'Uthman extended al-Masjid al-Ḥarām, enlarged it, bought the houses [to be destroyed]. But some people refused to sell [their houses]; nonetheless he destroyed them; and he put the money in the *bayt al-māl*. As these people [whose houses had been destroyed against their will] denounced him, he put them in jail. He then told them: 'don't you know what made you so insolent toward me? It is my gentleness that made you so insolent. 'Umar has done the same, and you did not dare denounce him!' Later 'Abd Allah Ibn Usayd interceded in their favour, and they were freed.³⁴

Issues of land and ownership clearly did not disappear during 'Uthman's reign. 'Uthman's expropriation of land provoked widespread discontent and violence despite the reputable status of his Meccan family heritage and the religious aims of his project. 'Uthman was even denounced by the people he had evicted, compelling him to invoke the precedent of 'Umar and to imprison his opponents. Reflecting on these events with hindsight, and with consideration of the extraordinary speed of the military success of the new empire, one wonders how such opposition could exist in the religious heart of the Islamic

empire, and how little interest in public matters these opponents demonstrated. Incidentally, one should mention that seen from this point of view, the later confiscations of church buildings look less than remarkable; when considered in the light of the expropriation of Muslims' homes, it becomes clear that faith is less relevant a motive than it may appear.

‘UMAR II: ARCHITECTURE AND PIETY³⁵

Yaqubi contributes to accounts of the Umayyad mosques in his discussion of ‘Umar II’s conversion to Sufism. In his report of the death of Qubayb, Yaqubi suggests a connection between Qubayb’s fate and ‘Umar II’s transformation. Yaqubi does not suggest a causal relationship between these two events, yet ‘Umar’s laments seem to focus solely on Qubayb’s death. Even if the link between repentance and wrongdoing is a strong one, becoming pious does not necessarily imply repentance. In this particular context, however, mystical conversion was identified with remorse and repentance.

Before becoming a Sufi, a devout mystic, ‘Umar Ibn ‘Abd al-‘Aziz had been a typical Umayyad. He also had had a brilliant career in the administration before taking power. First al-Walīd appointed him governor of al-Madīna when he was only 25 years old. Three years later, he was named governor of Mecca and Taef as well. Finally, he became caliph in 99 AH.

His mother, we are told, was the granddaughter of ‘Umar Ibn al-Khattab, the second caliph of the prophet. Sulayman selected him to be his heir to the caliphate. As reported by Tabari, Sulayman’s testament reads:

This is a testament by ‘Abdu Allah Sulayman, Prince of the faithful, to ‘Umar Ibn ‘Abd al-‘Aziz. I have granted you the Caliphate as my heir. [And then, addressing the Umayyad family, he continues.] ‘So listen to him, be obedient, respect God, and do not quarrel or create factions.’ And indeed all the Umayyad members declared their allegiance to him except ‘Abd al-‘Aziz Ibn al-Walīd Ibn ‘Abd al-Malik who was absent, and who proclaimed himself Caliph. But upon

learning of 'Umar's enthronement, he went to Damascus where 'Umar received him and said to him: 'I have heard that you proclaimed yourself Caliph and wanted to enter Damascus.' He answered: 'That was because I had heard that no Caliph was designated and I feared Fitna.' So 'Umar said: 'If you really meant to be Caliph I would not have fought you over that.' 'Abd al-'Aziz answered: 'By god, you are the only one whom I believe should care for the Caliphate.'³⁶

Tabari's account of 'Umar's accession to power corroborates Yaqubi's. Tabari also states that at first Sulayman intended to nominate his son as heir. But his friend and adviser, Rajā Ibn Ḥaywa, counselled him to do otherwise because his son was too young to rule the community deftly. So he chose 'Umar on condition that his son, Yazid Ibn 'Abd al-Malik, would in turn be 'Umar's successor. The caliph touted this scheme as a way of unifying the Umayyads, who were then divided into conflicting factions. This, of course, suggests that some of them opposed 'Umar's nomination. Hicham Ibn 'Abd al-Malik, who expected to be the new caliph, expressed his dissent, but was forced to pledge allegiance.

According to one version of Tabari's narrative, this factional situation within the Umayyad family brought about 'Umar's murder. It is said that a rebellion broke out in Iraq. The caliph, who staunchly opposed the bloodshed of Muslims by Muslims, sent a messenger to the rebels asking them to send two representatives to discuss peacefully in his presence the reasons for their dissent. During their discussion with the caliph, the rebels insisted on knowing why he was confirming Yazid as his successor. He answered that it was someone else's decision. Then they asked him: 'If you were entrusted with something, and you in turn entrusted it to someone else who revealed himself to be unworthy, would you still feel responsible?'³⁷ 'Umar asked them to allow him three days to reflect on this question before giving them his answer. Members of the Umayyad family feared that 'Umar would dispossess them of their wealth and proclaim that Yazid was no longer the successor to the caliphate. They therefore poisoned 'Umar, who died three days later. Even though Tabari gives other

versions of 'Umar's death, and although nothing can prove that he was in fact poisoned, Tabari's account clearly highlights the existence of factions, or at the very least tensions in the royal family.

All the tales about 'Umar concur in suggesting that he was not interested in power, and mention his humility and sense of responsibility. It is said that he spent all his time striving to bring justice and concord back to the Muslim community. His faith and commitment to his duties are described as saintly in character. His life has always been portrayed as the exemplar of a good Muslim ruler. The Sunni tradition thus considers him among the *Khulafā' Arrāchidūn*, the legitimate caliphs, the first four successors of Muhammad. And 'Umar Ibn 'Abd al-'Aziz was the only caliph among the Umayyads and the 'Abbasids to be honoured by that title. The expression 'God bless the two 'Umars' (*Raḥīma Allāhu al-'Umarayn*) also testifies to the esteem shared by Muslims for 'Umar II.

It is understandable that the otherwise continuous social unrest ceased under his rule. Shī'a and Kharidjis seem to have been convinced by 'Umar's leadership and sense of justice. Many historians have described the Umayyad caliphate as 'the Arab Kingdom', a society still in its formative stages in which traditional tribal ties were just beginning to give way to a new sense of national belonging. The new society was composed of diverse social groups from a variety of cultural backgrounds. Indeed, the Arab conquerors came to rule over peoples whose civilizations and historical weight they themselves lacked. The rapid expansion of the empire was largely due to the lure of booty and the wealth the Arab Bedouins could amass through conquest. These continuing financial incentives helped secure the cohesion of the regime, and were maintained by the regular revenues paid to Arab soldiers through the *diwan*. The cohesion of the regime ensured, in turn, the continuation of conquest.

By this time, however, the empire had reached its geographical limits, and booty, as a source of income for the *bayt al-māl*, was rapidly dwindling. Thus, the income of the treasury depended on taxes. The *jizīya*, or poll tax, which each non-Muslim monotheist had to pay in exchange for protection, freedom to exercise his

religion and safety, became of fundamental importance to the financial equilibrium of the regime. This partly explains why the Umayyads adopted a policy of non-proselytization; even contrary to Islamic rules, new converts to Islam were submitted to the *jizīya* despite their protest. This was an effective means of discouraging conversion.

Sensitive to these concerns, 'Umar departed from previous policies and decreed that converts to Islam were thenceforth exempt from the poll tax. 'Umar's decree met strong resistance among the higher echelons of the administration. Al-Jarrāḥ, the notorious governor of Khurasan, is said to have continued the unjust practice against the converts even after 'Umar's decree, claiming that people had eagerly converted to avoid paying the poll tax, and started checking whether they had been circumcised to verify their faith. When 'Umar learnt of this, he sent him the following message: 'God sent Muhammad as a messenger, He did not send him as circumciser.'³⁸ Then he sent for al-Jarrāḥ and discharged him.

In contrast to his predecessors, 'Umar initiated a new form of leadership based on social justice and the pursuit of peace among Muslims. His powerful social commitment was a welcome departure from the long line of despotic Umayyad caliphs (with the exception of the diplomatic Mu'awiya, founder of the dynasty). Even the Umayyad governors, especially those appointed in Iraq, were authoritarian, if not simply bloodthirsty.³⁹ Al-Ḥajjāj, the despotic and sanguinary governor of the Umayyads, is rumoured to have said:

It is a more important duty to obey me than to obey God, because God says: 'Obey me as much as you can' whereas He [also] says 'Listen and obey [your rulers]' without any possible exception! That is why if I order a man to cross a door, and he does not, I have the right of death over him.⁴⁰

'Umar was wholeheartedly opposed to his predecessors' authoritarian policies and the nepotism they entailed, as exemplified by his relations with the Umayyad family.⁴¹ Since the

caliphate was a kind of elected kingship among the members of the Umayyad family, the elected caliph was supposed to bestow on his electors gifts of money and property; the Umayyad family members had, by the time of 'Umar's reign, accumulated great wealth. Needless to say, this wealth was often extorted unjustly from others, which is how he himself had inherited 'Fadak', a land that Mu'awiya, the first Umayyad caliph, had extorted from the descendants of the prophet's daughter Fatima. 'Umar, however, chose to return it to its legitimate inheritors. Yet, when Yazid Ibn 'Abd al-Malik became caliph, he again expropriated it. 'Umar confirmed all the Umayyads' possessions, but did not grant them any more land.⁴²

It seems that at the outset of his governorship in al-Madīna, 'Umar sought to act in accordance with the religious leadership. On his arrival in al-Madīna he invited ten 'ulama (plural of 'ālim), experts in religious affairs, to tell them how he intended to rule. He asked them to help him ensure justice among Muslims and to prevent any undesirable incident. He insisted that he would not rule without heeding their advice and asked them to inform him of all misdeeds so as to keep al-Madīna a holy place. His invitation to the 'ulama may also be read as an attempt to dampen their criticism and secure their support. It is only a posteriori that his al-Madīna policy could be read as religiously motivated and as an act of respect for theologians. The sentence imposed on Qubayb and his death during the construction of the mosque tend to counterbalance the interpretation of him as a religiously motivated ruler to portray 'Umar as an *homme d'état* like any other Umayyad governor.

Most scholars view the change in 'Umar's behaviour from a mundane ruler to a Sufi as an example of zealotry, and this is well documented in many historical sources.⁴³ He had been an ordinary prince who enjoyed listening to music, eating good food and wearing fine clothing. No robe could be smooth enough for him when he was prince. His change upon accession to leadership of the caliphate was complete. He stopped listening to music, eating good food and wearing fine clothing. He could wear the cheapest robe and find it smooth and delightful. He only enjoyed clothes

made from the coarsest fibres and the simplest meals. He even asked his wife to give up her jewellery and embrace the same austere lifestyle.

He turned all his energy to worship and public welfare. For example, he ordered Sulayman Ibn Abi Asīrī, his governor in Samarkand, to build caravansaries, to host all Muslims for one day and one night, and to lodge their mounts. The sick could stay an additional day, and those without resources could receive grants to pay for their return home. His thoughts seem to have been fully preoccupied with accountability before God. In one of his speeches, he supposedly said: 'O people, you were not created purposeless, you will not be abandoned in vain,' meaning to stress the need for responsible behaviour in anticipation of the Day of Judgment. The notion of accountability before God thus became his leitmotiv. Correct behaviour presupposes accurate knowledge of religious duties and an active pursuit of the good, since knowledge and behaviour should mirror each other. For Muslims, it is a religious duty to seek knowledge and share this learning with others. Yet, the reciprocal support of knowing and doing stops short of the Mu'tazila principle of a duty to enforce the law. The caliph could not endorse the Mu'tazila principle requiring all Muslims to enforce the law. Indeed, as caliph, 'Umar was conscious of the importance of retaining law enforcement in the hands of the caliphate state. Certainly, 'Umar's zealous Sufi behaviour and excessive reforms were far from being an expression of bigotry. His close ties with the pious-minded preachers did not prevent him from being a shrewd politician and making important tax reforms.⁴⁴ His wisdom is clearly documented through the egalitarian way in which he treated all the provinces, the peace he was able to establish and the various reforms he put in place.

It is in this global context of social reformation that al-Jāḥiẓ's account of 'Umar II's project concerning the mosque at Damascus makes sense. The fact that 'Umar II supervised the construction of the Umayyad mosque at al-Madīna, which is considered a keynote in the evolution of the architectural typology of the mosque, and that he was credited as the first to make the *miḥrab* in the form of a

niche and with a dome in front of it – two key architectural innovations – show that he was an unusually capable royal architect. This expertise makes the change of his attitude towards architecture more meaningful.⁴⁵

Umayyad architecture had a very rich social content, with important political implications. First, it was seen as a princely art. Indeed, it was mainly for this reason, according to al-Jāhiz, that the ‘Abbasids destroyed the Umayyad palaces. It was for this same reason that Ibn Khaldun called the mosque at Damascus *Bulāṭ al-Walīd*, meaning that the building showed little suitability as a mosque, and was more explicitly designed to advertise al-Walīd’s power and wealth. In fact, all contemporary literary sources associate the earliest symbolic use of architecture with the Umayyads, even if certain sources report that the prophet rebuked his wife Umm Salama, who chose to build an addition to her apartment when he was away on an expedition.⁴⁶ Mu‘awiya is said to have built a green palace, probably because the building included a green cupola. He also used to sit with his companions in al-Khadra, under the green dome, in the mosque at Damascus.⁴⁷ Moreover, Masūdi reports that even on the battlefield, Mu‘awiya commanded the battalions from under a *qubba*.⁴⁸ All these details point to the same conclusion: very early on there was a symbolic use of architecture by Mu‘awiya, while no such use is reported for the so-called orthodox caliphs. Is it not extraordinary that while Mu‘awiya was seated under a green cupola, Ali, who was the official caliph, was mounting a mule – the prophet’s mule, but nonetheless a mule – and fighting? This contrast between the humble caliph and the arrogant usurper was not simply meant to criticize Mu‘awiya and to mock him as a coward, but to accuse the Umayyads of installing segregationist practices among Muslims.

The second element concerning the social content of architecture is that it represented public expenditure and, as such, had to be conducted justly. After promising not to commission any building, Yazid III swore to renounce the transference of public revenue from one town to another unless all the needs of the former town had been honestly satisfied. Indeed, to meet rulers’ ostentatious desires, important architectural works were reputed

to have mobilized the resources of all the provinces of the empire for one particular province and to have left all the others without financial means. The poem about the Damascus mosque cited earlier in this chapter points to this state of want and describes the absence of the Umayyads' hospitality.

Nonetheless, mosques were necessary spaces for worship, teaching and other public gatherings. Inasmuch as Umayyad mosques had important religious meanings – like that at al-Madīna – or quickly acquired them, as did the al-Aqsa Mosque, they were exempted from criticism. Furthermore, new mosques needed to be built if the demographic expansion of the Muslim community was to continue, encouraged as it was by the tax reforms initiated by 'Umar II. For this and other reasons, a debate must have taken place about the decorative appropriateness of mosques. Reports of 'Umar II's project to unadorn the mosque at Damascus and his renunciation of that project assuredly means that a debate must have taken place among the members of his administration. His renunciation should not be seen as the triumph of princely mosque architecture, but as a political retreat from a position exceedingly damaging to the Umayyads' public stature.

Yazid III's later promise not to build confirms that the Muslim community, or at least a large part of it, did not welcome ostentatious architecture, and for the Umayyads it was no longer attainable. The evolution of the architectural typology of the mosque under the 'Abbasids, as Oleg Grabar described it,⁴⁹ with a less exuberantly ornate style (in contrast to that of the palaces, which kept a variety of decorative motifs and techniques), points to the existence of a serious debate, for that evolution could hardly have been a spontaneous and accidental outburst specifically oriented towards mosques.

It is uncanny to note the similarities between 'Umar II's final attitude toward architecture, as reported by al-Jāhīz, and that of Saint Bernard, the twelfth-century reformer of the Cistercian order. 'There is no need to mention the immense height of your oratories, their excessive length and width, their sumptuous decoration and pleasant paintings, whose effect is to attract the attention of the faithful and reduce their concentration power.'⁵⁰ If

Saint Bernard succeeded in creating an architectural style and making the Cistercian order formulate explicit rules for religious art, 'Umar II may be credited with initiating a theoretical debate that ultimately led to the creation of the 'Abbasid mosque and its temperately ornate style.

Whatever role 'Umar II may have had in this evolution and in the consequent debate, the main point of the reports on his 'projects' for the mosque at Damascus remains the rise, very early in Islamic history, of a strong criticism of Umayyad building activities. It was this criticism that ultimately determined the evolution of Umayyad and 'Abbasid architecture and its break from the art of late antiquity. Terry Allen is indeed right, at least for the Umayyad period, when he says that 'the direction taken by early Islamic art is not a radical change of course from the aesthetic trends of Late Antiquity' and that 'we tend to see early Islamic art as radically new not because it was, but because we collapse the time scale over which it developed new forms, and we identify the end product, later Islamic art, with its origins.'⁵¹ One should remember that hiring Christian masons for the mosque at al-Madīna was among the grievances held against the Umayyad rulers for it allegedly gave them the opportunity to sully the holy mosque. This grievance links Umayyad architecture to Christianity. And, even today in the twenty-first century, Muslim fundamentalists reject Umayyad architecture as being Christian as opposed to 'Abbasid architecture.

In another book al-Jāhīz points again to the political status of buildings and its unavoidable relationship with violence when he reports on Ziyād, the brother of Mu'awiya, the first Umayyad caliph, and his building works in al-Basra.

When Ziyād built his works in al-Basra he ordered his agents to investigate and hear what people were saying about it, so he was presented a man who recited a verse from the Qur'an: 'Do you build a landmark on every high place to amuse yourselves? And do you get for yourselves fine buildings in the hope of living there for ever?'⁵² Ziyād said: and what pushed you to this [criticism]? The man answered:

a verse from the book of our Lord, Glory and Majesty on Him, crossed my mind and I recited it. Ziyād replied: By God I will do to you what the next verse says: ‘And when you exert your strong hand do you do it with absolute power?’⁵³ Then he ordered the man to be buried under one of the corners of the palace.⁵³

6

Architecture and Desire

There are Baroque armchairs that are too important for any use and turn the peculiar attitude, the quasi-removed task of sitting down into something new, somewhat uncanny, like a fairy tale, a most peculiar line.

(Ernst Bloch)¹

It does not lead to anything to feel in a beautiful way. It remains internal. It has no way to get to the outside. Nothing is communicated. In much the same way the interior is presupposed whenever there is any artistic creation. There has to be an ego behind the applied colors, a hand that applies. There is a feeling that passes through the hand in motion that becomes part of the painting.

(Ernst Bloch)²

Proponents of the mainstream functionalist approach to the study of art, such as Oleg Grabar and Robert Hillenbrand, have analysed the development of the typologies of architecture in the Islamic world as a process of trial and error that has mainly taken into account the requirements of glorification of power, memorialization and ceremonial, ritual and ordinary usages. On the other hand, proponents of the spiritualist trend (Ardalan, Bakhtiar, Titus Burckhardt and Seyyed Nasr) have drawn upon Massignon's work to present the history of the architecture of the Islamic world as an incremental process aiming towards the concrete manifestation of a spiritual worldview. Burckhardt, for instance, has suggested that the Taj Mahal epitomizes the concretization of the spiritual as it is

dedicated to love. As I argued in Chapter 3, in agreement with Oleg Grabar, the spiritualist approach overlooks the basic historical time gap between the formation of the architecture of the Islamic world and the later development of Sufi views of art. This makes their connection, at least in the formative period of that architecture, theoretically inconsistent.

Now, like Ernst Bloch's Baroque armchair, whose form surpasses mere functionality, architecture cannot be reduced to the materialization of some function, even if this function is the celebration of power, or the memorialization of events. In the buildings of the Islamic world, as in all great monuments, there is always something *like a fairytale* – something the American writer Washington Irving took advantage of with great talent when he used the Alhambra as the setting of some of his stories. This fairytale dimension was present in the earliest buildings of the Umayyad dynasty, and was even more striking in 'Abbasid monuments. In their description of the works of the 'Abbasid caliphs, Ettinghausen and Grabar remark on the 'uncanny aspect' of the disproportionate size of the 'Abbasid palace, which they call a city-palace. But, as a rule, scholars have either devoted inadequate attention to the 'uncanny' or fairytale aspect, or embellished it into myth.

I argue that it is this poetic quality – the fairytale dimension of architecture – that ultimately determines the success and future of monuments. It does so because it conveys 'the feeling that passes through the hand in motion', which becomes part of the work and engages the beholder. Thus, it seems, to my mind, that any attempt at constructing a comprehensive theoretical view of the architecture of the early Islamic world should assign a central place to the poetic dimension and to 'the feeling' that the work conveys.

Tabari writes:

When Ziyād wanted to build [the mosque] he summoned masons 'of the days of Ignorance'. He described to them the location of the mosque, its size, and how high he wished it to be (*wa mā yashtahī fī ṭūlihi fī al-samā*). He also said that he wished to erect a building that would be without equal. A

man who had been one of the builders of Khusrau replied that that could only be accomplished by using columns from Jabal Ahwās, the drums of which should be hollowed out, drilled, and fitted together by means of lead and dowels of iron. The roof should be 30 cubits (15 m) high. The building should have sides [porticoes?] and backs [porticoes?]. Ziyād then said: ‘that is what I desired, but I could not express it.’³

The story of Ziyād and his masons not only illustrates the relationship between masons (or architectural planners) and patrons in terms of power, but it also introduces two crucial features that are at stake in architectural planning – desire and its expression. The expression of desire is one central aspect of the poetic and fairytale nature of architecture. When Ziyād wants to articulate his satisfaction with the building he says, ‘It is what I desired, but could not express.’ Does this simply mean that he appreciated the work enough to recognize in it some of his feelings? Is Ziyād’s recognition of his feelings in the architectural work tantamount to the experience of a reader who identifies with the feelings of the author of a book? After all, as Roland Barthes writes, to fall in love with a book is like saying: ‘This is what I would have loved to say but could not express.’

Yet, it seems that Ziyād’s statement, and its context, are not wholly comparable to the situation Barthes describes. For, whereas the author of a book must first of all find inspiration in himself and freely express his own feelings and ideas, the task of the architect is, at least in theory, to interpret and express in architectural form the desire of his client.⁴ A reflection on the relationship between architects and clients also raises some fundamental theoretical questions. Should an architectural work be read as the shared object of people’s desires, or rather as an object of desire in a structure of inter-subjectivity? How is it possible for one person to express the desire of another? And how does the architect’s own desire intervene in that process?

In reflecting on these questions, I would like to propose that diverse desires merge in the process of architectural creation and that conflicting desires shape and motivate architectural inno-

vation, and may serve as the foundation for the complexity and contradictions central to architectural poetics. This relatedness of desire and architecture in early Islam, I argue, shows that the gaze has a central role in architectural planning, and that the investigation of other literary sources (medical and theological sources in particular) confirms that, very early in the ninth century CE, and contrary to a common belief, the preoccupation with the implication of the gaze with desire was central to Islamic culture.

‘ARCHITECTS’ OR ARCHITECTURAL PLANNERS

An analysis of the context of the production and reception of architectural works helps us better understand the architect-client relationship. In the Introduction I suggested that in Grabar’s discussion of the process of formation of the art of the Islamic world, his opposition of a process in which the ‘entire community’ reached ‘a collective consensus’ to one of ‘a theoretical reflection that would have acquired the quasi-legal status of a doctrine’⁵ refers to a theoretical opposition rather than to a real one. Indeed, artistic production has always been the work of ‘deciding groups’,⁶ and not the object of collective consensus.

Furthermore, artistic – and in particular architectural – production is a process in which the patron always has the last word in defining the programme, if not also the design.⁷ A poet or even a painter can be imagined working in isolation, and therefore presumably completing works of art in a relatively autonomous way. This is inconceivable in architecture, for architects or builders always work for clients or patrons. This asymmetrical relationship necessarily restricts the freedom of the architect, for his travail is determined largely, if not fully, by his client, and the views of other people connected to the latter.⁸ For example, when designing a house an architect will have to incorporate the client’s programme and the desires of the client’s family members. The work of the architect is thus not simply the expression of his own intimate artistic views, but first and foremost the expression, or rather the concretization of the desire of the client. This structural relationship between the architect and the client or patron is so fundamental to architectural production that in myths it is often

revealed to be fatal for the architect, as I discuss at length in Chapter 3. Indeed, the relationship between the architect and his client may vary from converging desires to conflicting ones.

A rigorous approach to the conditions of production and reception of architecture raises three further sets of questions:

- Who were the creative agents? Were they master masons, mathematicians, equivalent to our modern-day architects, or simply the patrons themselves who conceived of the building plans?
- How did these agents perform their creative works and what were the principles upon which they proceeded to construct them? Did they make drawings or models? Did they collaborate on the work?
- And, finally, how did they communicate with both their patrons and with the workers on the building site?

Even though these three questions are related, art historians have previously discussed them separately. Architectural historians have rarely sought to analyse the status and role of the planners of architecture in the Islamic world. While there are numerous studies of the design principles and typologies of buildings, analysts have only recently started to think about the communication required by the material process of construction. L. A. Mayer, in his *Islamic Architects and their Works*, was the first person to attempt to define the figure of the ‘architect’ – or of the person responsible for conceptualizing architectural design – in Islamic societies prior to the nineteenth century. Mayer states that:

The picture of the architect as it emerges from the *ḥisba* – manuals written by and for market inspectors (where each important trade and profession is mentioned together with a list of cheating tricks most common to that calling, and police methods to prevent, discover and guard against fraud) leaves us in no doubt as to how small the real difference between an architect and a foreman mason was – if such difference ever really existed.⁹

Indeed, written evidence such as that discussed by Mayer, suggests that the difference between master mason and architect was insignificant compared with the current distinction between these two roles. It seems that the term ‘architect’ is, perhaps, inappropriate in the context of early architectural production, as it is inconsistent with the traditional conception of the architect as the ‘literate’ person in charge of both the conceptualization of building designs and the supervision of their construction.

Islamic documents, as Mayer indicates, refer to the involvement of a variety of professionals over time. Authors sometimes attribute the conception of a design to a ruler, as in the case of Abu ‘Inān, or Muhammad b. Qalāwūn, and sometimes to a mathematician [*ḥāsib*], as with Ahmad b. Muhammad, who restored the Nilometre on the Rauda in 861 AH.¹⁰ As for the supervision of the works, something like a ‘superintendent of the works’ seems to have existed with different regional appellations over time: *ṣāḥib al-mabāni* in Umayyad Spain, *shādd al-‘amā’ir* in Mamluk Egypt, and the *binā’ emini* in the Ottoman Empire.

Limited evidence make it particularly challenging to delineate the different roles involved in architectural production in the first centuries of Islam. Of all the personages Mayer mentions – ‘all men known to have been architects, engineers, and master masons’,¹¹ and whose works can be identified – only six seem to have been working in the eighth and ninth centuries CE. Indeed, two terms that appear in literary sources – *muhandis* and *bannā’* – do not seem to be equivalent to our conception of ‘architect’. In *Kitāb al-‘Ayn* (circa CE 800), the earliest Arabic dictionary, the word *muhandis* is defined as the person who calculates the size and location of *qanāt*, water channels, and does not seem to relate in any way to architecture.¹² In the tenth century CE, al-Azhari also defines *muhandis* as the person who calculates the size and location of water channels, but adds that the word also connoted learning, hence the expression *fulān hindawsu hādhā al-‘amr* (meaning that a person is learned in a particular field).¹³ The word thus acquired the connotation of technical expertise; still, it seems not to have had any particular association with architecture. Likewise, the word *bannā’* can be defined as mason or builder. Therefore, the term

architect does not seem to be appropriate in the context of early Islamic societies. Yet, if the 'architect' did not exist as such, how were the conceptualization and supervision of architectural works carried out and by whom?

Literary sources mention that the supervision of works was entrusted to reliable people from civilian and military backgrounds. These sources seem to indicate that teams of learned people were sometimes responsible for the conception of architectural and urban design. Thus, al-Muqaddasi says that 'When al-Manşur wanted to build Madinat al-Salam he convoked those who best knew theology, and law, those who were trustworthy, and those who knew *al-handasa*.'¹⁴ Similarly, when 'Umar Ibn 'abd al-'Aziz was in charge of building the mosque of al-Madīna he discussed its entire plan with the religious authorities of the city. Furthermore, the ruler himself sometimes made the design decisions: al-Muqaddasi writes that when Ibn Tulun decided to build the harbour of Aqqa:

He called an assembly of all the artisans of the city, and explained to them [what he planned to build]. He then said that no one knew how to build in the water at the time. Then the name of my grandfather *Abu Bakr al-bannā'* was mentioned and the king was told that if someone knew that [how to build in the water] it would be he.¹⁵

Most literary sources seem to suggest that the individuals and teams in charge of developing architectural designs did not necessarily possess technical knowledge related to building. Architectural design, as a series of decisions aimed at defining forms (as in the case of the Umayyad mosque of al-Madīna), appears to have been developed independently of any of the technical knowledge that was ultimately necessary for the construction of the proposed buildings. Of course, such a design process would have been viable only to the extent that the planned projects were technically possible to construct. It thus seems more reasonable to assume that the client-patron; the individual or team in charge of the supervision of works; and

masons and other artisans all collaborated and participated to varying degrees in the conceptualization of the architectural design. Such a relationship would account for the well-known claim of so many rulers that they were the authors of their buildings. I shall henceforth use the term 'architectural planner' to designate the conceptual author (either person or team) whom I assume to have been in charge of the development of designs.

Architectural Planning

The question of how the early architectural planners of the Islamic world completed their creative works, and expressed the interwoven desires of client and designer, beckons an analysis of the methods of architectural planning of the period. I have shown in Chapter 3 how certain principles characteristic of these methods, such as successive divisions into three, were structurally similar to Arabic poetics. Unfortunately, apart from the buildings still standing, there is no available evidence documenting the actual practice of architectural planning in early Islam. Renata Holod¹⁶ and, subsequently, Jonathan M. Bloom¹⁷ recently explored the issue from the perspective of the transmission of architectural knowledge. Both authors agree that in the early Islamic period the mode of inter-regional transmission determined the appearance and trajectory of regional change. Renata Holod suggests that paper, which was introduced to Islamic societies in the eighth century, became an important vector for the transmission of architectural knowledge: 'The supra-regional elements of transmission whether verbal or visual, were on paper; the local traditions continued to be transmitted mostly by gesture. Both are based on, and tied together by, a thorough knowledge of geometric construction.'¹⁸

In contrast, Jonathan Bloom argues that while 'actual plans and architectural drawings from the Islamic world as well as unequivocal textual references to them indicate that plans were used as early as the thirteenth century',¹⁹ there is no clear evidence of plans having been used before that time. Moreover, when considered in terms of the transmission and influence of architectural models, the monuments of the early period show

deviations between 'models' and 'copies' that seem to indicate a verbal rather than graphic transmission. For example, there are striking differences between the proportions of the plan of the mosques of Samarra and of Ibn Tulun in Cairo, and there are notable differences between the shapes of the similarly placed minarets in Samarra, Qayrawān and Siraf in Iran (*circa* CE 815–25).

Another illustration of the likely absence of the use of a graphic system in the regional transmission of architectural knowledge is the way in which the arrangement of the three domes over the *maq̣sura* in the mosque of Córdoba differs from its supposed prototype in Damascus. Bloom explains that, 'While the prototype in Damascus had three domes arranged in a line in the direction of the *qibla*, a misunderstanding in the verbal transmission would allow for the three domes at Córdoba arranged perpendicular to the *qibla*.'²⁰ The author concludes that in the early centuries of Islam, the transmission of architectural knowledge was probably based only on verbal transmission.

There is, indeed, no evidence of the use of graphic documentation in the transmission of architectural knowledge. Yet, how can we reconcile this absence of graphic documents and plans in the inter-regional transmission of knowledge with the fact that graphic systems of representation were not only known, but were also employed in the planning process? Given the absence of graphic documents in the diffusion of ideas, it is difficult to imagine that they were, in fact, used in the building process. If plans had been in use in building, why were they not transmitted from one place to another? However, as Spiro Kostof suggests, it is possible that 'the Muslim architect prepared drawings for his buildings'²¹ given the existence of stories about several architects whose hands were chopped off upon the completion of a masterpiece so that they could not reproduce the design for another patron.

The general proportions of the plan for the Dome of the Rock and the high degree of precision in its execution, as analysed by K. A. C. Creswell, indicate the possibility that it was set out graphically. Furthermore, there were clearly graphic representations of buildings, such as the celebrated mosaics of the mosque of Damascus; and plans of buildings, possibly mosques, are

depicted in the frontispiece of a Qur'an on an eighth century CE parchment found in San'ā, Yemen.²² However, in the Yemeni document, plans and elevations are combined in an intriguing way, which suggests that these images are probably neither representations of actual buildings nor reproductions of architectural plans designed for practical purposes.²³

The rapid dissemination of the 'Abbasid stucco, brilliantly documented by Margaret van Berchem, resulted from the export of panels and their reproduction locally.²⁴ But the most important factor in the transmission of designs was likely to have been the migration of craftsmen. The conscription of labour the Umayyads practised prompted this migration, which must have continued in different forms.²⁵ However, to gain a clearer understanding of the evolution and forms of transmission of knowledge and construction techniques, it will be necessary to investigate further the history of crafts and labour.

Given the complex geometric figures used in buildings, it seems certain that on the one hand, architectural planners possessed a thorough knowledge of geometric construction and graphic systems, which they used to set out the plans of buildings. On the other hand, it appears that models of buildings and drawings of plans and elevation did not exist at the time. I would like to suggest that we can reach a clearer understanding of this paradoxical situation by defining the theoretical functions of a system of visual notation, and of the different ways these functions have been fulfilled. In architectural production, any system of visual notation must have three functions, which can be defined roughly as follows. First, it must help the planner set out the plan of a building, and define with precision the forms and proportions of its parts. Second, it must preserve this information to make it available for the actual construction on site, and help organize and control the erection of the building. And third, any system of notation must serve to show an image of the project to the patron and, ideally, convince him or her of the merits of the project.

The geometric nature of the architecture of the Islamic world and the certainty that graphic systems were used indicate that the first two functions, the making of plans and their use in con-

struction, were fulfilled through some medium of graphic representation, and were probably drawn on a perishable material. As for the third function, in the absence of any evidence of plans or models in the early centuries of Islam, it can be assumed that the communication between the architectural planner and the patron was very likely based on verbal exchange and the visual memory of architectural images. The fact that the patron was often a part of the team of planners may help explain the absence of any medium of representation for the purpose of showing him the image of the projected building.

Al-Takhṭīṭ wa al-Tasṭīr: The Hidden Order of Architecture

The thought must be hidden in a verse like nutritive virtue in a fruit. It is food but seems like pure delight. We only feel pleasure, but we also receive substance.

(Paul Valéry)²⁶

The vocabulary of construction may contain useful indications about the nature of the system of visual notation of the time. The term *khaṭṭa*, which has received ample interest from historians, is the first that comes to mind. In an article entitled 'Khaṭṭa and the Territorial Structure of Early Muslim Towns',²⁷ Jamel Akbar discusses in detail the use of the term in early Arabic literature. He concludes that:

khaṭṭa in the early Islamic period meant the act of claiming a property, often but not necessarily by the claimant's marking it out with lines or structures to establish its boundary after he obtained the ruler's permission to do so. It represents the first step in the building process, but does not necessarily involve the internal organization of the property.²⁸

Early Arabic dictionaries seem to suggest that the word encompassed a broader meaning. Al-Khalil's *Kitāb al-ʿAyn* (CE 718–786?) recalls various ways in which the term has been employed: 'al-khuṭṭah: *mina al-khaṭṭ* [comes from the line] ... *al-takhṭīṭ ka al-tasṭīr* [it is like marking lines]. ... *Al-khaṭṭu: al-kitābah* [is writing and

the like that is marked by lines].²⁹ Ibn Durayd (CE 837-933) also recalls that '*khaṭṭa al-shay*' *yakhuṭṭuhu khaṭṭan, idhā khaṭṭahu bi qalam 'aw ghayrih* [to draw something is to mark it with/through lines, in other words marking it with a pen or the like].³⁰ Al-Azhari (CE tenth century) also comments on the parallel between writing and *al-tasṭīr*, or drawing lines.³¹

Evidently, the meaning of the word *khaṭṭa* is not limited to the act of claiming property; it also connotes writing and marking lines. Furthermore, according to al-Khalil, *khuṭṭa* means *qissa*, a story, but also courageous and entrepreneurial, as in *fi ra'si fulan khuṭṭa* [he has a plan in mind] (Ibn Durayd). This suggests that the word connoted planning and intention, as in the Italian *diseġno*, which is at the root of the term 'design'.

The suggestion that the meaning attached to the word encompassed planning and intention is confirmed by the word *al-tasṭīr*, given as a synonym for *al-takḥṭīṭ* [from *kaḥṭṭ*: line; drawing lines; planning]. Al-Khalil says that

al-saṭr is a line in books, or a line of planted trees, and the like. ... We also say: *saṭṭara fulān 'alaynā al-tasṭīr* [if he tells fraudulent stories about us]. ... And *yaṣṭuru* means to compose. ... *Saṭṭara, yaṣṭuru* to write ... *assaṣṭara maṣḍar al-musaṣṭir* is the *maṣḍar* (or verbal noun) of the dominant, which is the tutor, the keeper, and guarantor of something.³²

Thus, like *khaṭṭa*, *saṭṭara* implies marking lines and writing. It connotes invention, and creation, as it is synonymous with composition. Remarkably, it also connotes power and the guarantee of ownership of land.

These definitions help explain the importance of al-Khalil's assertion, '*al-takḥṭīṭ ka al-tasṭīr*' [planning is like marking lines]; as in craftsmanship, the term *al-tasṭīr* means the marking of the lines of geometric construction upon which a decorative composition is made. The *al-tasṭīr* is the key of any decorative pattern and composition: it is the craftsman's great secret. But the singularity of the *al-tasṭīr* is that once a decoration is complete, the lines that

mapped the geometric construction are no longer visible (figures 2a and 2b). The *al-tasṭīr* is thus a hidden structure that makes possible the construction of decorative patterns and compositions. It seems as if the *al-tasṭīr* proceeds from the power of the *musayṭir* [the dominant], which is the tutor, the keeper and guarantor and, in this sense, it could be said that the hidden geometric construction was somehow a guarantor of the quality of the decoration.

Thus, it seems legitimate to enquire whether the well-established geometricism of the art of the Islamic world could not be explained by the ‘invention’, ‘creation’, ‘power’ and ‘guarantee’ associated with the notion of *al-tasṭīr*. Indeed, *al-tasṭīr* encompasses the existence of a hidden order upon which the craftsmen build their works. This is so prevalent that one of the most demanding exercises of students of art is to decipher and reconstruct the geometric constructions underpinning decorative patterns (as in figures 2a and 2b). I would like to stress the fact, however, that in the early centuries of Islam, this hidden order did not have any Sufi or mystical content. To my knowledge, the only philosophical view to which it could, indeed, be related is al-Jāhiz’s theory of *al-bayān*, elaborated in Chapter 2. The connection stems logically from the similarities between the notion of *al-tasṭīr*, and the mechanisms of ‘*‘aqd*, calculation, and *ḥāl*, the state, both central to *al-bayān*.

THE DESIRE FOR ARCHITECTURE

Since the work of Freud (and in particular Freud’s study of Leonardo da Vinci published early in the twentieth century), the notion of desire has become an ordinary trope of modern views of art.³³ Surrealist artists went so far as to make Freud’s views a guideline of creation, proclaiming the expression of desire, as materialized in dreams and the free association of ideas, the central focus of their works. Thus, it has become common among art critics today to believe that desire underpins any work of art, and that art is the expression of desire.

It is not my purpose to challenge this view, yet it is important to note that no work of art can be reduced to the simple expression of desire: all artists build on the works of the past, and

every work of art is related to works that preceded it, and it therefore participates in a history that transcends that of the individual. It is thus, perhaps, simplistic to view architectural production simply as the concretization of a patron's desire. For, in strict Freudian terms, the desire that is said to be expressed in a work of art is that of the artist. In Freud's theory, the personal history of the individual, for instance Leonardo da Vinci's childhood, helps explain, through the mechanism of sublimation, the theme and the composition of a painting. The desire and psychic configuration that structure the work of art belong to the individual who created it.³⁴ How do we reconcile this view with the situation of an architect and his patron? How should we interpret Ziyād's claim, as reported by Tabari, that his desire is being expressed by his mason? And what is the place of the mason's own desire?

Perhaps a broader understanding of the notions of desire and the subject, as proposed by Lacan, can afford a better understanding of Ziyād's claim. For, in Lacan's view, the 'subject' cannot be reduced to the 'individual', even if the former cannot be imagined without the latter. From this perspective, desire may be exchanged by people, if not simply shared. Let us assume, at this point, that a desire can be exchanged, for desire indeed circulates between people in paintings, literature and films. Desire can arise reading a text³⁵ or watching a film. The psychological devices employed in advertising presuppose the possibility of desire circulating between and among people. The discussion about desire I am proposing is not out of place in a reflection on architecture, for, as al-Tha'ālibi says: 'building is a desire, *ladhdhatun*, like the desire for women and wine, and ... to have some of it always pushes [one] to desiring more.'

Al-Tha'ālibi's prose on the role of desire in architecture is surprisingly modern. In the passage that follows, he weaves connections between power, desire and aesthetics that are striking and unusual for his time:

Among the signs of kings through time [one finds], *Min rusūm al-mulūk 'alā wajhi az-zamāni*: founding cities, mag-

nifying buildings, erecting fortified citadels and magnificent palaces, and the love of beautiful monuments. That is why the poet says:

*inna āthārunā tadullu ‘alaynā
fa-nzurū ba‘danā ‘ilā l-’āthāri*

Our monuments bear witness to ourselves,³⁶
therefore, after we are gone, look at our works

What Ali Ibn al-Jahm says about some buildings of al-Mutawakkil in one of his poems is a most beautiful statement:

And I still hear that kings
build for their pleasure
I also know that the eminent spirits
are recognized through their monuments
When I saw the building of the Imam
I knew the Caliphate was in the right hands
Great courtyards where the gaze travels
and weakens because of its immensity³⁷
And a royal dome so radiant as if
the stars were confiding in ‘him’ their secrets.

How charming also was what the poets said to al-ṣaḥīb [b. ‘Abbād]:

*wa-liya mas’alatun ba‘du
fa-‘ājjilnī bi’ikhbārin
banayta ad-dāra fī duniyā-
ka ‘am duniyāka fī-ddāri*

I have a question could
you please give me a quick answer
Have you built a house in your
world, or a world in your house?

This he took from the answer of Abu al-‘Aynā’ [an author and poet, 191–283 AH] when he was asked by al-Mutawakkil ‘what do you think of our home, *dāranā hādīhi?*’: ‘Oh prince

of the faithful, I have seen people building houses in this world, but you built a world in your house.' It is desirable for a king to compete with other kings in building without exaggeration, and without excessive expenditures that could hurt his treasury, which is the supporting socle of his power and organization of his kingdom, the ammunition of his army, and the resources of the day and the morrow. It is known that building is a desire like the desire for women and wine, *ladhdhatun ka ladhdhati an-nisā' wa-l-khamr*, and that to have some of it always pushes [one] to desiring more, *wa ba'ḍuhu yad'ū ba'ḍan*.³⁸ Thus, there is no limit to the amounts of money that royal buildings require. It is a duty of the king to spend [on buildings] with moderation, to make the buildings large enough, to know well what he is founding, to heighten what he builds, and be sure to make it stand for eternity rather than as ephemeral ornamentation.

[It is wise] not to waste money as al-Mutawakkil did in his projects in *Sirr man ra'ā*, where he spent more than any other king who ruled before or after him. He delighted himself with novelty, and called every building with [a lusty name] such as the king, the bride, the morning, the beautiful, the strange, the marvellous, the elect, the Ja'fari, the pearl, and so on. His expenditures amounted to three hundred million dirhams, details of which are accounted in the books of Akhbār al-'abbasiyin. They thus ruined the treasury of the Muslims, and had very bad effects on the caliphate and the kingship. Moreover, all his projects did not outlive him long. Most of them fell in ruin, or disappeared. Only unstable ruins and obliterated and crumbling signs remain.

Al-Manṣur did not spend even the tenth of a tenth of that amount to build Baghdad, which was the best, the most beautiful, the largest and most lasting city in the world. That is because he built it solidly and with wisdom whereas al-Mutawakkil built his buildings with unreason, weakness, and many other defects. ...

It is a good custom and a memorized legacy of kings to do the good, embellish monuments, to repair roads, to build

Ribāts, to erect mosques, to found cities and villages, and to fortify citadels:

A hero must be a model and
leave on Earth some monuments.³⁹

Architecture and the Pre-eminence of the Visual Realm

Al-Tha'ālibi's account raises many questions about the perception and function of architecture during the early Islamic period. The principal protagonists of his story are the caliph and two poets. The first poet, Ali ibn al-Jahm, praises al-Mutawakkil's buildings and presents them as great royal deeds. The second poet, Abu al-'Aynā, criticizes the works of the caliph and warns him against the pitfalls of desire and, specifically, the desire for building. It is remarkable that both poets, each in their own way, compare buildings with women. Abu al-'Aynā traces this connection in prose, and Ali Ibn al-Jahm does so in a poem, whose beginning is quoted by al-Tha'ālibi.

Thus, two poets are concerned with al-Tha'ālibi's account, and both draw a connection between buildings and women; but one of them praises the royal works and the second criticizes them. Now, from *Kitāb al-Aghāni* we learn that, later on, al-Mutawakkil became very dissatisfied with Ali Ibn al-Jahm, the poet who celebrated the marvellous caliphal palace. Al-Mutawakkil thus sent the poet to prison before sentencing him to an exile during which he was to meet his fate.⁴⁰ Given the nature of the caliphate and the tyranny of this particular caliph, there seems to be nothing extraordinary in Ibn al-Jahm's fate. But the fact that the other poet, who criticized the ruler, does not seem to have been harmed raises an important question: what would explain the fact that the author who praised the caliph was punished and not the one who criticized him? Furthermore, why did the caliph ask his question in the first place, and why would a powerful ruler like al-Mutawakkil take heed of the opinion of a poet in such a matter as the quality or the appropriateness of the royal home?

I shall show below that the answer to these questions resides in the nature of the visual realm and its connection to desire. But first I want to point out the remarkable importance that many

authors have afforded to the visual domain in historical writings on al-Mutawakkil. Masūdi begins his report on al-Mutawakkil by narrating the royal invention of new attire, and how it became fashionable.⁴¹ He also reports on al-Mutawakkil's adoption/invention of *al-binā' al-ḥayri*, or the building fashion of *al-ḥīra* with two sleeves. He writes:

Al-Mutawakkil created a [plan] of building that was unknown, which is known as *al-ḥīri* with two sleeves and porticoes. That happened when some of his companions told him that a king from *al-ḥīra* had created a [new type of] building on a battle plan as a constant reminder of war for he was very inclined to it, and did not want to forget it even for an instant. There the audience was in the breastplate with two sleeves to the right and left. The rooms which are the sleeves are for his retinue, the right one was the storage place of his clothes, and the left one of beverage. The breastplate opens in the court in the portico, and the triple gate and the sleeves also open on it.⁴²

This preoccupation with appearance illustrated in the adoption of original clothes and in the perception of architecture as a representation and visual reminder of military activity suggests that there was intense focus on the visual world. It also points to the existence of an implicit assumption about the visual world as a system of representation.

Furthermore, al-Mutawakkil used this system of representation as a semiotic form of control and social segregation. Tabari reports that the caliph did not simply use splendid clothes to indicate social distinction, and parade with the *'Anaza*, or lance of the prophet,⁴³ but he also imposed restrictions on mounts and distinctive clothes on the religious minorities of the empire. He adds that, in addition, al-Mutawakkil forbade Muslims from teaching the children of these minorities.⁴⁴ Thus, al-Mutawakkil's investment in the visual is related to his preoccupation with authoritarian control and social segregation.

It is also said that, for obvious political reasons, he ordered

the demolition of the tomb of Ḥusain Ibn Ali and the neighbouring houses, and the ploughing and planting of all their land.⁴⁵ The remodelling of that landscape, too, testifies to an acute sensitivity to the political implications of buildings. The constant preoccupation with the visual order, the insatiable desire for building, and the extensive architectural projects that ensued, led al-Mutawakkil to fatal excesses. Thus, when he planned to build al-Ja‘fariyya, he tortured many dignitaries and extracted large sums of money from them, which likely accelerated his own impending assassination.⁴⁶

Back to Desire

Historical accounts about al-Mutawakkil suggest that his search for visual order stems from underlying desire. All authors seem to indicate that there is a link between the visual order; its effects in terms of social segregation; the fatal excesses of the ruler; and insatiable desire for building, or simply insatiable desire. Thus, it is said that the Caliph al-Mutawakkil, whose excesses are the object of our concerns, had 4000 concubines and that he had sexual intercourse with all of them.⁴⁷ This further speaks to the perceived connection between power, architecture and women.

I suggest that to understand these links better, we should explore the fundamental connection between desire and the visual realm in general. Earlier, I mentioned how Freud’s work instituted a connection between desire and the visual arts. Freud’s view, however, has been criticized on the grounds that a biographical event or childhood trauma cannot explain the fundamental features of art. As André Malraux writes:

The limits of the biographical approach, its negative attitude – ‘if Goya had not been ill, he would not have painted the figures of the *House of the Deaf*’ – prevent it from doing any more than circumscribing genius: as for secrets such as determining conditions, they become useless where art begins: at quality.⁴⁸

Certain scholars have likewise criticized Freud’s views on art, and

his essay on Leonardo in particular, for paying inadequate attention to the specifics of art. According to this criticism, Freud sought to explain art by recourse to biographical events, and neglected the specific function of art itself. Yet, Lacan's reading of Freud tells us that the fecundity of Freud's work does not reside in the relationship of biographical or traumatic events to works of art. Rather, its contribution lies in its insight into the connection of desire to the visual realm. What, then, is the nature of this relationship?

In discussing the impact of Leonardo's early experiences on the artist to be, Freud asserts: 'The instinct to look and the instinct to know were those most strongly excited by the impressions of his childhood.'⁴⁹ The work of Leonardo appears in Freud's essay as the evolution of a dialectical relationship between the two instincts. When the instinct to look is the leading drive, the artist comes to the fore; and when the instinct to know takes the lead, the scientist supersedes the artist. In other words, when desire is invested in the visual realm, Leonardo is more productive as an artist. But when his desire is channelled into intellectual curiosity, his energy is diverted toward knowledge and his artistic activity is eclipsed by his scientific mind. On the other hand, Freud seems to view the smile of Mona Lisa as a central feature in the artistic maturation of Leonardo:

When, in the prime of life, Leonardo once more encountered the smile of bliss and rapture which had once played on his mother's lips as she fondled him, he had for long been under the dominance of an inhibition which forbade him ever again to desire such caresses from the lips of women. But he had become a painter, and therefore he strove to reproduce the smile with his brush, giving it to all his pictures (whether he in fact executed them himself or had them done by his pupils under his direction) to Leda, to John the Baptist and to Bacchus.⁵⁰

The interesting feature in Freud's argument is not the connection between art and a past event, but instead between the desire (of

the lost smile) and painting (the systematic depiction of that smile in different paintings).

Freud goes a step further in his exploration of that connection when he discusses the composition of another work by Leonardo, the London cartoon of 'St Anne with Two Others'. In a note of 1919 he writes:

If an attempt is made to separate the figures of Anne and Mary in this picture and to trace the outline of each, it will not be found altogether easy. One is inclined to say that they are fused with each other like badly condensed dream-figures, so that in some places it is hard to say where Anne ends and where Mary begins. But what appears to a critic's eye as a fault, as a defect in composition, is vindicated in the eyes of analysis by reference to its secret meaning. It seems that for the artist the two mothers of his childhood were melted into a single form.⁵¹

Beyond pointing to the contextual meaning of Leonardo's work, Freud's remark draws an interesting comparison between painting and the images of dreams, which was to become a vein largely exploited by Surrealist artists. Freud's comparison of painting to dreams leads to two conclusions. First, like the dream, painting is a medium and a vehicle of desire. Second, the design or composition of a painting is comparable to dream figures, which in Freud's theory are constructed as cryptograms.⁵²

Building on Freud's analysis, Lacan suggests that in painting there is something that is always elusive, but secretly asserts itself – '*le regard*', or the gaze. This gaze is by definition mine, as I am the subject who sees, but it is also someone else's gaze 'on me', as I am the object of an imaginary gaze from the other. This is not the gaze of another person I can see looking at me, who can move or inhibit me (as with someone who is shy). Rather, it is an imaginary gaze 'that I imagine in the realm of the other'.⁵³

In the Sartrean situation referred to by Lacan, in which the voyeur behind the keyhole feels the gaze of the other despite the fact that he is, in fact, the onlooker, the subject is affected by the

gaze inasmuch as he or she is a subject of desire. It is this gaze that floods the works of art, and stages them as a world of representation constructed on the basis of a desire (of or to the Other) aiming at *donner-à-voir*, or a showing offered to the gaze. This logic inscribes the relation of the gaze upon its object as illusion, and allows the eye to function on the level of lack – because, for Lacan, desire stems from a lack (*manque*). In its function as art, painting operates on the social realm because it offers to viewers something that can appease their desire to see. But this also may function on the level of illusion, as indicated by Plato's contempt for painting as something that claims to be what it is not.⁵⁴

How can the Lacanian theory of the gaze help us understand the production and function of architecture? First, we should ask how does architecture participate in the world of representation? When Masūdi describes al-Mutawakkil's invention of a new type of building, known as '*al-ḥīri with two sleeves*', he indeed tells us that, at least in this particular instance, architecture functions as a representation of the battlefield. In fact, it can be asserted that architecture is but another medium of representation.

Al-Jāhīz reports that this was the case in ancient Persia and he describes how Arabs borrowed the Persian practice of using architecture as a medium of social distinction. Moreover, as I argued in the Introduction, in the early centuries of Islam, architecture was a complex art in which building, decoration and painting came together in the production of built space. Architecture was therefore a complex medium of representation integrating spatial organization, painting, mosaic and other decorative techniques.

Arab authors' descriptions of royal buildings, which emphasize the wealth and splendour of their decorations, hanging textiles and furniture, corroborate this view. The debate that 'Umar Ibn 'Abd al-'Aziz evoked over decoration in the Great Mosque at Damascus, as discussed in the previous chapter, looked into the possible effects of decoration on the mind. In Lacanian terms, this debate raises the question of the capture of the gaze by a system of representation, and how the *donner-à-voir* affects the viewer.

The functioning of architectural decoration as 'a trap for the

gaze' and object of fascination is perhaps the most common device ensuring architectural efficacy as attested to by art history. Yet, in certain contexts and historical periods, this characteristic has met with strong opposition and criticism, as was the case with Saint Bernard's impetuous criticism of Gothic architecture. And, in the case of modern architecture, the modernist opposition to ornament is best illustrated by the Viennese architect Adolf Loos's motto, 'ornament is a crime'. We can likewise understand the poet Abu al-'Aynā's criticism of al-Mutawakkil in the same vein. And it is remarkable that the former not only discusses decoration, but also extends his critique to architecture in general.

It is now possible to return to the question of why al-Mutawakkil requested a poet's opinion of the royal palace. Abu al-'Aynā's renown as an eminent intellectual is not enough to explain the caliph's solicitation of his opinion, for the caliph's pre-occupation is in fact more common than it seems: most people are concerned with the opinion of others about their houses.

It is not simply because home is a mirror of the self that people are concerned with how others perceive them in that mirror;⁵⁵ it is also because buildings are staged with the gaze aiming to capture the gaze or gazes of others. It is for this reason that the caliph wants to know how the poet reacts and if he is fascinated by the palace. But here we are: where the caliph and Ibn al-Jahm play the game of desire, the second poet, Abu al-'Aynā' perceives a blunder. When the caliph invites the poet to feast his eyes on and enjoy the new palace – the pleasure of building is comparable to that of sex, says al-Tha'ālibi – the poet forsakes the realm of pleasure for ethics and begins lecturing the caliph. Abu al-'Aynā' (his gaze) is not caught in the play of desire; instead he moves on from the level of desire to which the caliph wants to direct him to that of ethics and law.

It appears paradoxical that Abu al-'Aynā's refusal to bestow his gaze on the palace, and his dismissal of the game of fascination and admiration in which the others indulge, does not seem to irritate the caliph. In fact, the poet's critical attitude can be interpreted not only as a lack of admiration but also as a demonstrative lack of envy. The expression of excessive admiration may be interpreted as envy and therefore perceived as harmful. Here we should recall

that, according to Lacan, the gaze is endowed with great powers, but harmful powers, and that the evil eye is a universal phenomenon that attributes to the eye the power to unleash destruction and death. In this respect, the question the caliph addresses to the poet can be viewed as aiming to make the poet talk about what he might envy and, in so doing, ward off the evil eye. The question could incite him to express his desire and forestall the rise of envy. It can also be deduced that a criticism is a proof of the absence of envy and its harmful effects (evil eye), which therefore makes the gaze harmless and acceptable.

ARCHITECTURE AND MISRECOGNITION

When Ziyād asserts that his mason built precisely what he desired but could not express his statement is only partially truthful. He certainly recognizes the building as something he would have desired, but how could he have desired something that never before existed? It is only by retro-projecting his satisfaction with the building onto the past, and the desire that this must have entailed, that Ziyād can assert the existence of such a desire in the past. The subject, Lacan says, is constituted in speech in a peculiar relationship between past and future:

What is realized in my history is not the past definite of what was, since it is no more, or even the present perfect of what has been in what I am, but the future anterior of what I shall have been for what I am in the process of becoming.⁵⁶

It is only through a similar process that Ziyād can maintain his assertion, and that the building could become exactly what he desired in the past. In Lacanian terms, it is not a question of reality (in the sense of verisimilitude) but of truth, a truth the subject expresses in speech – a speech whose effect is ‘to reorder past contingences by conferring on them the sense of necessities to come.’⁵⁷ It is in this sense that Ziyād is telling the truth when he makes the statement about his desire and the building, as if expressing his satisfaction would amount – did in fact amount – to making the building the object of an actual desire that was there.

Of course the desire was there, but only as a lack whose object had yet to take shape.

In the logic of the relationship between the architect and his client, Ziyād's situation is that of the 'felicitous' encounter. It is the best that could happen to a client, for it is not the general outcome of that relationship. Architects and their clients may enjoy very close and warm relationships, but this does not imply that the users of buildings often find themselves in a situation similar to that of Ziyād. In housing projects, the users may have no direct contact with the architect, which makes the situation more complex. In fact, the absence of direct contact between architects and users seems to have been particularly problematic in the historical contexts of architectural innovation. The works of such an innovative architect as Le Corbusier are well known for the dissatisfaction of their users: the façades of the houses in Pessac in Bordeaux have all been remodelled by their owners, and the apartments of the Cité Radieuse in Marseilles have been deserted by their tenants. Even the Villa Savoy, which Le Corbusier conceived for a client he personally met and knew, was definitively vacated after only six months of residency.⁵⁸ These examples demonstrate how large the gap between the architect and the inhabitants of his buildings may be. They also illustrate the sometimes conflicting desires of architect and client, a feature central to architectural innovation.

The relationship between architect and client seems to rely first on the existence of a common architectural background and language. It is known, for instance, that until the thirteenth century the builders of Gothic cathedrals did not have recourse to a precise system of representation with plans drawn to scale, and that, nevertheless, this did not prevent them from efficiently communicating and discussing their projects with their patrons.⁵⁹ Furthermore, as John James has shown, different teams of masons could work in successive seasons on the same building site without recourse to such plans and still cooperate in the production of the same project: this was made possible by the use of the same know-how about methods of design and construction.⁶⁰ In the early Islamic period, the existence of a comparable architectural vocabulary and

background shaped the relationship between architect and client. But whenever innovative architectural developments occur, there is some sort of impasse, or break, in that relationship, and the architect appears to be at odds with his clients: it is particularly telling that the people called Le Corbusier's Cité Radieuse in Marseilles, France, '*la maison du fada*', the house of the cracked.

The early development of the architecture of the Islamic world, I suggest, should be understood as a period of production based on the existence of a shared background and architectural vocabulary comparable to that of the European Gothic builders. This background is composed of architectural patterns and forms; names of spaces and places (it is their naming that makes spaces and objects meaningful); symbolism of space (sacred and profane); myths of origin and of grandiose architecture; and what I called above methods of architectural planning. It is reasonable to assume that this common background allowed patrons and architectural planners to discuss and negotiate the plans of their projects without recourse to architectural drawings or models. It is also upon this background that desire could circulate from planners to patrons, and make it possible for an object designed by a mason to become the object of desire of a ruler.

THE TRAVELLING GAZE: IBN AL-JAHM'S EULOGY OF THE PALACE AL-HARUNI

In al-Tha'alibi's account, he includes only four verses of Ibn al-Jahm's poem about the palace of al-Mutawakkil. The entire poem as published in the *Diwan* contains 24 verses. When considered as a whole, the poem traverses a wealth of themes that point to the complexity of its author's view of architecture. The poem begins with the first two verses quoted by al-Tha'alibi, and proceeds to evoke the Persian and Byzantine monuments and laud their prestige. In reading the first 18 verses, let us note the depth of the poet's knowledge of architecture:

And I still hear that kings
 build for their pleasure
 I also know that eminent spirits
 are recognized in their monuments

The Byzantines have what their ancestors built
 and the Persians the monuments of their noblemen
 When I saw the building of the Imam
 I knew the Caliphate was in the right hands
 We believed in the pride of the Caliphate
 and you reinforced the pride of its leader
 On behalf of the Muslims, to testify against
 the atheists and infidels, you erected
 Marvels that neither the Persians
 nor the Byzantines ever saw
 Great courtyards where the gaze travels
 and weakens because of their immensity⁶¹
 And a royal dome so radiant as if
 the stars were confiding in 'him' their secrets
 Therein flowing delegations prostrate
 when the dome shines before their eyes
 When the dome shines the eyes show
 the roots of their eyelashes
 When its flame burns in Iraq
 the Hijaz is lit by its flare
 The balconies of the palace look
 as if Spring clothed them with flowers
 Mosaics are set on them like jewels
 adorning young women and virgins
 They are like virgins shining with candles
 in the procession of a Christian festival
 Some have braided hair and
 a sash around the waist
 And a terrace on top of a high building
 overhanging a garden of fruitful palm trees
 Whenever the wind blows, there arise
 songs of the slave musicians and their ...⁶²

(Six additional verses follow.)

Ibn al-Jahm's poem exploits almost all the themes I have sought
 to address in this work. The first theme is of architecture and
 pleasure, followed by the notion of architecture as evidence of

wealth and power – a widely recurring theme in literary sources. The second theme evoked is the celebration of past civilizations through monuments. Ibn al-Jahm thus speaks of Persian and Byzantine grandeur, but only as a rhetorical device to introduce the idea of competition, and to show how al-Mutawakkil's works surpassed all the monuments that preceded them. It is interesting to note that in the poem the caliph does not act for himself; he acts on behalf of all Muslims. It is as if he were acting on behalf of the Muslim community in its entirety and on the legitimate basis of its proxy. This mechanism of representation and/or identification – between the caliph and the community – means that the monuments were not only his but belonged also to the Muslim community as a whole, thus qualifying the latter to compete with the Byzantines and Persians.

The poem thus corroborates Oleg Grabar's thesis that early buildings can be read as political statements and proclamations of the superiority of the new faith over Christianity and Judaism. Moreover, given that the poem dates to the ninth century CE, it represents an earlier source than the tenth century text by al-Muqaddasi on which Grabar partially builds his argument.⁶³

Before moving further into the analysis of the poem, and in as much as we recognize the building described by Ibn al-Jahm as the Bakuwara (see figure 15), it is worth quoting Creswell's description of it:

The palace of Bakuwara is not only, on account of its size, an architectural work of the first order, it is in addition rich in architectural ideas. Thus one may observe the most impressive increase in effect obtained by the proportions and the laying out of the courts and by the varying form of the gateways, culminating in the triple-arched façade decorated with mosaic ... doubly skilful in the use of the site. First of all the palace is so placed that one standing in the central room sees towards the north-west the mighty line of halls, the three courts of Honour with their gateways and the streets of the outer quadrangle; to the south-west the halls, the garden, the river, and the limitless undulating

plain of the Jazira. ... Such an axial composition is of incomparable grandeur and monumental effect. In the second place, moreover, the great area is not even, and the slight differences in level are employed and increased so that the whole middle strip is somewhat higher than the side strips, and in it again there is a rise from court to court. The level of the Throne-Room surpasses all other parts of the palace: its floor-level is about the same as the level of the flat roofs of the lateral strips.⁶⁴

After the poem pronounces the superiority of the caliph's building projects, it proceeds to describe those projects. In contrast to the symbolism apparent in the introductory verses, the themes evoked here are more sensually related to the buildings. First, Ibn al-Jahm evokes the gaze of the onlooker: the gaze travels and, in harmony with Creswell's description, weakens due to the great size of the buildings. Ibn al-Jahm borrows this idea from an earlier author, al-Aḥnaf, who explains that the quality of a building has to do with the ability of the gaze to travel in it – to move about unobstructed by a visual trap or a narrowness of space. Is it not possible to recognize here the theme of variety, analysed in Chapter 2, that al-Jāhīz notes as essential to the quality of a work?

In Ibn al-Jahm's poem the movement of the gaze leads the viewer to the royal dome, very likely in the throne room, to which the stars whisper their secrets. Here, the symbolism of the dome is clearly linked to the heavens: its light illuminates the eyes of the viewer but also the land of Islam, or via a synecdoche, the Ḥijaz, here again in harmony with Creswell's description. It is remarkable that when the dome shines, it does not become more visible; rather, the eye of the viewer reveals the roots of its eyelashes. The balconies crowning the palace are clothed with flowers and look like virgins adorned with jewels; buildings, the poet suggests, are like young women and virgins. It is worth noting that a few decades later all the themes present in the poem by Ibn al-Jahm are found in the work of Ibn al-Mu'taz. There too, marvellous palaces are said to be magical works and testimony of wisdom only comparable to Solomon's creations, and balconies are compared with virgins seated in artistic poses.⁶⁵

Finally, as in al-Hamadhāni's *Al-Iklil*, the wind makes the buildings sing songs of beautiful female slaves.⁶⁶

Legislating the Gaze

Now let us return to the question of the movement of the gaze. The gaze travels, and well-designed architecture should not obstruct its path. We might ask whether this perception of the gaze is simply a poetic trope, or if, on the contrary, it is representative of a particular understanding of the gaze that the intellectual community shared and, perhaps, diffused more widely in popular culture. This question is crucial, for if an Arabic theory of the gaze existed beyond the poetic trope, then one can posit that the views the poet developed about architecture – and in particular those views concerning desire – may also have been more widely spread, rooted in Islamic culture.

One possible answer to this question lies in the legislation of the gaze as developed in works of theology and law. The writings of al-Shāfi'ī (d. 204 AH/CE 820) detail a comprehensive legal system concerning the visual.⁶⁷ His work is the earliest surviving text on Islamic theology and law.⁶⁸ His *Kitāb al-Umm* develops a complex argument about the gaze in the context of prayer. The argument explores two major issues – clothing and the physical disposition of the faithful in prayer. The issue of clothing is introduced on the level of propriety, but is also discussed in principle. The faithful must wear clean and decent clothing. Decency of clothing is defined with precision according to gender (for example hiding the 'awra, pudenda, or 'weak spot'): 'The 'awra of a man is ... between his navel and his knees. But his navel and knees are not part of it. But when praying a woman must veil all her body except the palms of her hands and face.'⁶⁹

Any failure to cover the 'awra, or part of it, invalidates the prayer. This means that clothing is fundamental to prayer. As extravagant as it may seem, there are, however – at least theoretically – situations in which prayer can be performed naked. The author enumerates these situations:

If the people sink [in a boat] and they get out [of the sea]

nude, or if they are dispossessed [by bandits] in the road of their clothes, or if they are caught in a fire and all their clothes are lost. If they are men and women, they must pray in [separated] groups or individually. The men pray alone.⁷⁰

The prayer must be performed more or less as usual apart from the fact that when men are praying, women must avert their eyes, and vice versa. The author elaborates specific situations and variations in great detail, such as that of a simple couple, or when a single piece of cloth is available to a large group. In all situations, the faithful are required to submit to a simple rule: that of visual decency, or protection of the *'awra*.

The requirement of visual decency in prayer is presumably based on the principle that prayer must be accomplished with devotion. The prophet has ordered that people must join in prayer in a state of *sakīna*, a God-inspired peace of mind.⁷¹ Therefore, the physical disposition of the members of the group in prayer should not disturb the state of *sakīna* of the faithful. This is why the gaze must be legislated. Men must stand in the front rows before the hermaphrodites, when there are any, and women stand behind them in the last rows.⁷² It necessarily follows that a woman cannot lead men in prayer. The order is dictated by the nature of the *'awra*, the weak spot of the body, and its effect on the viewer. Women have the greatest *'awra* and therefore have to stand in the last rows where they cannot be seen by the men. The hermaphrodites, whose existence is regarded as unquestionable, are of mixed nature and must stand in between.

According to al-Shāfi'ī's theory, this order is not alone sufficient because the erotic effects of the *'awra* on the viewer remain too strong. There must accordingly be more restrictions, both on clothing and on the posture of the body during prayer. Whereas men can perform prayer in a relatively relaxed physical manner, women must perform prayer in such a way that their bodies will be as compact as possible, and 'their clothes will not reveal their body'.⁷³ One may wonder why women should be burdened with these regulations if they are required to stand behind the men and cannot, therefore, be watched by them when performing prayer

collectively. I suggest that the only explanation for this is that the 'awra is not only their 'weak spot' but also a source of eroticism, and that an imaginary viewer, who could potentially be seduced, is (unconsciously) assumed to be watching. This means that, as in the Sartrean view described above, the gaze of the other is supposed to be integrated into the woman's awareness of her body and of herself. Or perhaps these regulations are simply about the obsessive lust of men, who are the authors of this legislation.

But the visual plays another role in the performance of prayer. It is required in determining the direction of the *qibla*, for God, explains al-Shāfi'ī, has created the stars as signs to help people find their way.⁷⁴ People are required to perform prayer in the direction of the *ka'ba*.⁷⁵ The eye functions here as a tool of knowledge, and it is specified that blind individuals should not perform their prayer before asking someone to verify that they are orienting themselves in the right direction. This is such an important issue that al-Shāfi'ī asserts that when one deviates from the proper direction while performing prayer, one must begin the prayer again. He goes so far as to prescribe the same remedy in the very theoretically scholastic case of a person who locates the proper direction, but becomes blind just before finishing the prayer.⁷⁶

Al-Shāfi'ī thus evokes vision in two contrasting ways. First it is a means of knowledge and guidance to determine the direction of prayer. This is the cognitive function of vision, with orienting as a principal aim. Second, vision is discussed in reference to the gaze, inasmuch as the gaze is connected to desire. Al-Shāfi'ī is so pre-occupied with the gaze that he claims that a blind man is, perhaps, fitter to lead in prayer than a sighted person. Thus he writes:

I like the fact of the blind leading prayer, [for] when the blind is helped to the direction of the *qibla* he is less inclined to be distracted by what his eyes could see [if he were sighted]. ... But I do not make the choice of the blind over the sighted, because most of the people the Prophet made *imam*, prayer leaders were sighted.⁷⁷

Remarkably, al-Shāfi'ī's argument echoes al-Jāhīz's account of

the Great Mosque of Damascus: the viewer can always be distracted and led astray by what he or she sees. It is based upon this view of the gaze in its connection with desire that 'Umar Ibn 'Abd al-'Aziz is said to have planned to unadorn the mosque at Damascus, and al-Shāfi'ī sees a crucial advantage in the blind leading in prayer. This awareness of the effects of the visual on the mind and the soul appears thus to have existed earlier and to have been more widespread in Islamic culture than most scholars have suggested. Many branches of Islamic culture, like theology, law and poetry, clearly display a comparable view of the visual as both a cognitive device and a realm for desire and entertainment.

Is it not remarkable that one of the first Arabic medical treatises, *Kitāb al-'Ashr Maqālāt 'alā al-'Ayn – The Book on the Ten Treatises on the Eye*,⁷⁸ ascribed to Ḥunain Ibn Isḥāq (CE 809–77) – discusses the eye at length? In his third treatise this author demonstrates a refined view of vision and its functioning:

Concerning the sense of vision, its first object is finer and more delicate and purer than the perceived objects of all the other senses. ...

The first of the objects of visual perception and the most prominent of them all is the perception of colours, because colour is something which the eye perceives in a superior manner according to its nature; and the eye alone perceives it in contrast to all the other senses, and at the same time with the colour it also perceives the body which has that colour and recognizes it, just as the sense of taste not only recognizes the flavour but also, at the same time the body in which that flavour is; the only difference being that the sense of taste and the other senses (must) wait until the perceived object comes to the human body in order that it may be perceived. But vision extends itself by means of the air until it reaches the coloured body. Therefore the sense of vision alone of all the senses is able to recognize not only the colour of a body but also its size and shape, and it recognizes, moreover, its situation and the intervening distance. Moreover it recognizes its movement, and

although this recognition is not that of an absolute perception, (nevertheless) no other sense is able to perceive these things with the exception of the sense of touch; for it (the touch) results either from deduction or from comparison with something which the individual has estimated by previous knowledge.

The following is an example: if a person is walking in the dark and holds a stick in his hand and stretches it out full length before him, and the stick encounters an object which prevents it from advancing further, he knows immediately by analogy that the object preventing the stick from advancing is a solid body which resists anything that comes up against it. What leads him to this judgement is that he knows from previous experience that movement and walking in the air is without any obstacle, whilst movement and walking against a solid body is not possible. It is the same with vision.⁷⁹

Ibn Ishāq seems to be interested exclusively in the cognitive function of vision. According to his theory, the sense of vision appears to be complex and to rely on reasoning. Interestingly, however, he recognizes that direction in space can be reached without vision, for he says one can recognize space in the darkness and, 'the blind man feels things with the stick.'⁸⁰ The stick of the blind plays the role of the 'look', *al-baṣar*, a 'lucid spirit' that runs from the brain to the eye, and then meets the surrounding air. Sometimes the 'look' returns to the eye, allowing it to see the reflection of images. Thus, for instance, 'if a man looks fixedly and steadfastly into the eye of his companion – at a time when the eye of his friend is healthy – he sees his own image in it.'⁸¹ '*Naẓara fī 'ayni ṣāhibihi ... naẓara tathabbut wa tafarrus ra'ā ṣūratahu fīhā. Wa dhālika liṣababi inkisāri baṣarihi fī dhālika al-waḳti mina al-qashrati al-raqīqa.*'⁸² It is significant that Ibn Ishāq says that to see his image the viewer must look steadfastly, which indicates an awareness of the emotional condition of looking into the eye of another.

In fact the author uses two different Arabic words *al-baṣar*, and *al-naẓar*, both translated into English as 'look'. The word *baṣar*

refers to the 'lucid spirit' that is reflected in the eye of the other or in the mirror. This is the spirit, 'which runs from the brain into the eye. When it has entered the eye and comes out of it, so that it meets the surrounding air, it strikes it as it were with the shock of a collision, transforms it and renders it similar to itself.'⁸³ The *başar* leaves the eye and when it meets a mirror it returns. It is a luminous spirit that circulates between the brain and the outside world, and makes *hāssat al-başar*, the sense of vision, possible.

The word *nazara* is more correctly translated as 'gaze'. In Ibn Ishāq's text the term has a psychological connotation attached to power and the human will. It is not only about the ability to see. The Arabic text says '*Nazara fī 'ayni şāhibihi ... nazara tathabbut wa tafarrus*', which means that to be able to see his image in the eye of another, the viewer must stand bravely and unmovable. In other words, he has to stand unflinchingly before the gaze of the other. This is the old game that all children play: it is a contest in which each player is caught in the gaze of the other, and in which the winner is the one who can stand longer the gaze of the other without lowering his or her eyes.

Thus, it is evident that Ibn Ishāq draws a distinction between the ability to see, *hāssat al-başar*, or the sense of vision, and *al-nazar*, or the gaze, which implies power and human will. The two notions recall the functions of knowledge and desire or pleasure of vision as developed in al-Shāfiī. We can therefore assume that Arab authors and intellectuals at the time were more interested in the phenomenon of vision than most scholars of Islamic culture have previously thought. Consider, for example, this passage by Ibn Ishāq on vision, light and colour, which is reminiscent of some famous observations by Leonardo da Vinci. Ibn Ishāq writes:

The sense of vision having been created so that colors should be recognized by it, it must necessarily be luminous, as only luminous bodies, and no others, have the peculiarity that they are transformed by colors. A clear proof of this is (furnished by) the air surrounding our bodies: it is when it is in the highest degree bright and pure that its transformation by colors is most marked. In the same connection we

sometimes find the following (facts): if a man is lying under a tree and the air is in this condition, the color of his clothes takes on the color of that tree, because the air has become imbued with that color. Moreover, we often see that the air takes on the color of the wall, if the air meets it when it is luminous, and it (the air) transmits the color equally to another body, especially when the color is one of the conspicuous ones such as white and red and other colors of intense brightness.⁸⁴

These observations by Ibn Ishāq would alone represent enough evidence of the sophistication of the knowledge of early Islamic authors of the phenomenon of visual perception.

BUILDING, REFLECTION AND EMPTINESS

One particular detail in al-Tha'ālibi's account of al-Mutawakkil's buildings deserves further attention. The author calls the city of Samarra *Sirru man ra'ā*, or the delight of the beholder. I would like to suggest that this detail is particularly revelatory; to understand its significance fully, it is useful to recall that the act of naming not only designates objects, but also brings things into being, and things exist in our knowledge only as we give them names. Naming relies on what Michel Foucault calls an 'operating table', 'a *tabula*, that enables thought to operate upon the entities of our world, to put them in order, to divide them into classes, to group them according to names that designate their similarities and their differences – the table upon which, since the beginning of time, language has intersected space'.⁸⁵ What lies behind naming is an order, a way of giving meaning to things.

From this perspective the story of the name of the city of Samarra is remarkably meaningful. Muqaddasi reports a charming anecdote on this subject:

Early on Samarra was a great city, and a dwelling of the caliphs. It was built by al-Mu'tasim, and extended by al-Mutawakkil. It then became a *marḥala*. It was so extraordinary and beautiful that it was called *Surūra man ra'ā*, the

delight of the viewer. Then this was abridged as Surmara. The city had a great mosque that was considered superior to that of Damascus. ... But now it is in a state of ruin. One can walk two or three miles without seeing a single [standing] building. The city is on the eastern side of the river, and on the west there are gardens. He built a *ka'ba* in the city, and ordered the ritual circumambulation to be performed there [instead of at Mecca]. [The caliph] also took [another site to replace] *Minā* and *'Arafāt* [two other important religious sites near Mecca] when he was misled by some princes who wanted to perform the ritual pilgrimage without leaving him. So when the city was demolished, and became how I said, it was called *Sā'a man ra'ā*, the affliction of the viewer, and it was abridged to *Sāmarrā*.

Muqaddasi's account of the naming of Samarra is interesting in that it underlines the intense preoccupation of its builders with the visual: the very name of the city is testimony to this preoccupation and illustrative of its complexity. This is embellished by the themes of delight and affliction. The complete shift from one state to the other is described in the mythical register; the city's fate is the result of the impious deviation of the ruler, precisely the will to substitute a new series of places for the sacred *ka'ba*, and *Minā* and *'Arafāt*. It was this attempt and the consequent subversion of the divine order of the world implied by the text that brought decimation and ruin to the city.⁸⁶ The delight of the viewer, which was perceived as a blessing, becomes an affliction. Consistent with the mythical genre, the narrative depicts the ills of vanity. It is the abusive and impious behaviour of a ruler misled by his friends, and, above all, by his own vanity that brings destruction to what was once the viewer's delight.

Beyond pointing to the mythical elements of the story, I would like to underline further theoretical conclusions that can be drawn from Muqaddasi's account. First, the caliph's goal and preoccupation in building the city was visual delight. Second, and more importantly, it was not the ostentatious display of wealth or excessive pursuit of pleasure that secured the destruction of the

city, for in Islam the search for pleasure, including sexual pleasure, is legitimate. Rather, it was the idea of replacing the sacred *ka'ba* that charted the city's demise. It is remarkable that the account does not convey any explicit contempt for elaborate and costly buildings or for the pleasure related to them. Yet, it is possible to argue that splendid architecture leads people astray and inspires them to commit irreparable misdeeds. It was the princes' inability to leave the caliph's luxurious company and the beauty of the architectural setting of his town that pushed them to convince him to undertake the sinful project that brought the city to its ruin.

On the mythological level one of the ethical statements of the account is that, like great buildings, decay and ruins are equally visible signs to contemplate and meditate. Yet, I shall suggest that the central message of the account is that architecture – as a means of seeking visual delight, that is, in so far as it is connected to desire – is necessarily contained within an inter-subjective structure of power, destruction, and death. This dialectic is perfectly consistent with the Lacanian view of the destructive power of the gaze, as described above. Perhaps the most vivid allegorical illustration of the entanglement of building and ruin entailed in the visual is in al-Hamadhāni's description of the tomb of King Nāshir al-Ni'am (the dispenser of goods):

He ruled after Solomon and Belqis one hundred and eighty-one years. And Shammar Yu'rish, son of King Nāshir al-Ni'am, ordered the remaining of the magicians of Solomon and Belqis to be brought to him and he ordered them to build a cupola of blue limestone for the tomb of his father. They made the work so well, anointing and smoothing it until it became a high fortress looking like a mirror (*mir'at al-sajanjal*). He walked around the cupola and saw himself and his horse and all those who were with him outside it and from all directions. He was pleased. And then he noticed that whenever a bird flew to it and tried to make a halt on it, the bird would see its image and would flee and no bird would stand on the cupola. Then the king ordered the jinns to stay around the tomb and forbid its approach.⁸⁷

7

Conclusion

It is a great temptation to try to make the spirit explicit.

(Ludwig Wittgenstein)¹

Ordinarily, a conclusion summarizes the theoretical results of a work and points to the general academic implications of these results. It often proceeds by recalling the author's hypothesis, describing his or her methods of analysis and/or experimentation (where experimentation is possible and required) and finally presenting the results. A comparison between the expected results and the ones actually obtained often yields tools that enable the researcher to assess the hypothesis and the theoretical views it entails. In the experimental sciences, discrepancies or even contradictions between hypothesis and results do not necessarily amount to the failure of the work. On the contrary, an experiment scientifically conducted that contradicts the original hypothesis translates into a positive scientific falsification (for example, Karl Popper). Such experimentation does, in fact, aid in the development of new theoretical views, for in Bachelard's terms, science is a fabric of errors that are accounted for and corrected.² In the humanities and in non-experimental sciences, observation and reasoning are the sole tools with which one can study discrepancies; hence, contradictions between hypotheses and results point to the inadequacy of the premises to understand the object of analysis, when they are not simply the sign of errant reasoning.

It is of course more rewarding for there to be as little difference as possible between hypothesis and results, for this fosters a sense of having hit the target thanks to a strong intuition. Because

introductions are often written at the end of a work it is sometimes tempting to remodel the hypotheses to achieve such a result. In this case, introduction and conclusion tend to mirror each other, and the intellectual complexity of the research, with its accidents, impasses and discoveries, is reduced to the simple confirmation of a good premise. Another common illusion related to this perception is that the logic of the textual presentation of the work – that is the actual structure of the text, with an introduction followed by several chapters, and ending with a conclusion – is similar to the actual genesis of the research. It is well known that this imposed chronological evolution is misleading, for the complexities of the genesis of a work are distinct from the standardized form of academic presentation. This is why I would like to say a few words about the actual genesis of this work and, in so doing, seek to draw some complementary conclusions.

It would have certainly been simpler if the form of presentation were faithful to the unfolding of the research, if indeed I had started by asking the questions that are presented in the introduction, and proceeded to answer them following the order of the successive chapters. The fact is that this order is different from the way the research was actually conducted. Chapter 5, for instance, was chronologically the first to be written. Chapter 4 followed. Chapters 2 and 3 were written consecutively, while the introduction was written in parallel with both and revised afterwards. Only Chapter 6 is the last chapter both chronologically and in terms of its placement in the text. I shall suggest that looking to the actual genesis of this text reveals something about the perception and social reception of architecture.

My hypothesis related to the notion of ambiguity in architecture. The starting point of my reflection was Oleg Grabar's views on this issue. Thus, the premise of my book was a discussion of what, in his *The Formation of Islamic Art*, Grabar calls one of the leading features of the art of the Islamic world, its ambivalence and ambiguity in the use of the signifier. In his view, architectural elements seem to have no specific meaning in their architectural context. What imbues an architectural element with meaning, argues Grabar, is its human use. This leads him to conclude that

human/social life was the primary determining factor in dictating the meaning of that art. In harmony with what Robert Venturi calls 'complexity' and 'contradiction' in architecture, I argued that it would be more appropriate to read this ambiguity as a poetic indeterminacy of meaning, in Roman Jakobson's terms. This poetic dimension of architectural language, I suggest, is more apt to explain the geometricism, ornamentalism and flexibility of the art of the Islamic world, as well as its inclination towards what Bataille called the '*accursed share*' – the sensuous production of form through the annihilation of sense. I further proposed that one's attitude towards architectural forms participates in a more general *mentalité* style of thinking and doing. Consequently, my attention was drawn to the question of the Islamic attitude toward the arts.

As I mentioned in the Introduction, a remark by Grabar convinced me of the necessity of an in-depth study of art that drew upon a different and varied body of literature, including the works of al-Jāḥiẓ and Ibn 'Abd Rabbih, in order to apprehend what the attitude toward the arts might have been. Al-Jāḥiẓ's account of the mosque at Damascus first led me to raise the issue of the early existence of a debate on Umayyad architecture, for the interpretation of the project as an indication of 'Umar II's zealotry was unconvincing. Soon, other literary sources strengthened my conviction that this debate did take place early in the eighth century and that the semiotic quality of architecture was used not only by the caliphs to magnify their reign, but also by their opponents in their political struggles. Poetry about the Umayyad monument, in the form of *hijā'*, and Yazid III's speech upon accession to the throne, indicate that architecture was conceived as a complex strategy of public expenditures, labour policy and spatial semiotics.

These conclusions charted the path to the next step of the research. For it became clear that the debate and the public critique that I assumed took place in the time of 'Umar, later must have crystallized in some popular form after migrating from the political arena. Thus, I became interested in the so-called myth of grandiose Arabian architecture, about which al-Jāḥiẓ had much to say as well. His narrative of the legend of Sinimmār was the starting point for my reflection on the myths that relate to Arab

architecture. The structural analysis of this corpus of myths about architects, builders, kings and their works, revealed a fundamentally ambiguous attitude towards architecture. Moreover, I found that the ambivalent attitude towards architecture expressed in these popular myths mirrored the attitudes expounded in theological debates. The common perception that the development of architectural works was a sign of God's blessing did not preclude an enduring criticism of architecture, viewed as vanity, lack of piety and a defiance of the might of God.

A conclusion to be drawn from the study of myths is that the social reception of architectural works is more complex than it first appears: Islamic societies perceived (and continue to view) architecture through these two lenses. This ambivalence does not stem, as Grabar argues, from our ignorance of the architectural uses through which architectural meaning was produced. Ambivalence and ambiguity are the effects of the poetic indeterminacy of meaning central to Islamic artistic thought, and of the equation of architecture with vanity. It is, indeed, reasonable to assume that the actual perception of buildings is determined by the sometimes conflicting views embodied in myths, legends, and stories.

At this point, a new and legitimate question emerged: what were the epistemological foundations of the production of architectural meaning in the early Islamic period, namely at the time of the formation of Umayyad and 'Abbasid architecture? Once again, recourse to the work of al-Jāhīz appeared to be crucial to defining the main features of that episteme. Indeed, the first book of *Kitāb al-Ḥayawān* (The Book of Animals) begins with the notion of *al-bayān*, a term that defies any easy translation, for it encompasses signification, communication, expression, information and manifestation. In al-Jāhīz's view, *al-bayān* is what makes the most fundamental dimensions of life possible; it is crucial to the organization of society, as well as to the construction of memory and history. It is the primordial component of society and civilization and the key to the transmission of knowledge and wisdom. It is also a connection between cosmological concepts and artistic techniques and practices.

Al-bayān is at once the process of production of meaning and its

manifestation. Using five intellectual devices (*al-lafz*, speech; *al-khaṭ*, writing; *al-ʿaqd*, calculation; *al-ishāra*, the sign; and *al-ḥāl*, the state) *al-bayān* operates through different mediums, such as architecture, poetry and the art of the song, or books. Architecture creates meaning, for instance, through *al-ʿaqd* and *al-ḥāl*. In this elaborate epistemological system, architecture, like poetry, assumes an important social role in the manifestation of *al-bayān*. Both architecture and poetry share the symbolic function of memorializing and celebrating, and they develop from the same procedure of meaning, namely *al-ʿaqd*.

I further explored the parallel between poetry and architecture suggested by al-Jāhīz by examining the history of the debates about the lawfulness of song, as this echoes the arguments evoked in the account about ʿUmar and the decoration of the mosque at Damascus. In Chapter 3, I discussed further similarities between Arabic poetics and Umayyad and ʿAbbasid architecture on the basis of both al-Jāhīz’s works, and Erwin Panofsky’s theory of the structural connections between the arts and human thought. Comparison between al-Khalil’s theory of language and versification, and the principles of design of Umayyad and ʿAbbasid architecture uncovers a few additional parallels.

To be precise, I should mention that I conceived of certain connections between al-Khalil’s linguistic views and architecture much earlier. Indeed, I was first convinced of the existence of such a connection when I read about his dictionary *Kitāb al-ʿAyn*. His conception of language as a combinatory system of *ḥuruf* (letter/sound) was reminiscent of the principles of design of the Umayyad and ʿAbbasid decoration. After closely reading the introduction to *Kitāb al-ʿAyn* and examining the structure of the dictionary, I was able to grasp more fully the parallels between al-Khalil’s theory of language and his contemporary architectural decoration. My investigation yielded unexpected and welcome results, however, when I realized that al-Khalil also invented Arabic versification. I was then able to connect the linguistic principle of *al-taqīr* (or the principle of successive divisions of the poetic verse into metric parts) and *tarij* (or recurrence) with the architectural planning method of successive divisions into three parts. This parallel some-

what reflected the conception of a uniform and continuous medium in both poetry and architecture. If parallels existed between architecture and poetry at this level, would it not be reasonable to expect the existence of other parallels at a higher level, precisely at the level of the *qaṣīda* on the one hand and the spatial organization of buildings on the other? This parallel was confirmed through my comparison of the structure of the Arabic ode (*qaṣīda*) to the organization of the 'Abbasid mosque.

The intellectual demarche described so far, with arguments built on separate findings and the enquiries that ensue, is thus more comparable to an impressionist painting constructed of clearly differentiated strokes than to a unidirectional argument realized through a consistent series of interrogations and answers. If the impressionistic nature of research points to the artificiality of the traditional unfolding of academic presentation (with an introduction, the body and conclusion), then it does not preclude a more traditional approach from being profitable and ultimately somewhat unavoidable. Yet, the presentation of research is usually markedly different from its actual historical unfolding. To think it is identical is erroneous, and yields mistaken views about the object of the enquiry.

Thus, for instance, the series of questions that arose about architectural meaning suggests that this meaning was composed of multiple layers – not only those implied by the analysis of the corpus of myths, but also those relating to the quality and stories of buildings themselves, as well as usage and personal attachment. The multiple layers of meaning and the role of the buildings themselves, as well as their usage in determining meaning, do not, however, preclude discourse from having a central role in architectural meaning. Here we are reminded of the role of language as a necessary medium in the emergence of meaning; that is to say that, however multiple and varied the meaning of an architectural element may be, it can only be apprehended and articulated through language.³ This is, I argue, why myths, stories, and legends, such as the myth of Daedalus or that of Sinimmār, or again that of the creation of the five classical orders of architecture, are so crucial to conveying and preserving the fundamental meaning of architecture.

It would be equally erroneous to presume that the genesis of the object of enquiry is identical to its historical presentation. For instance, one might assume in reading this book that because the chapter on *al-bayān* precedes the ones on architecture and poetics, and myth, the epistemological basis of architectural meaning needs to be constructed before any actual meaning (in the form of myths) can exist; or that the parallels between poetry and architecture were effectively built on the notion of *al-bayān*. The fact is that this is hardly conceivable, and that the genesis of the social and epistemological structures of architectural production requires further study.

As I mentioned earlier, the last chapter represents a point of convergence, where all the theoretical threads addressed in the previous chapters merge to weave a more elaborate picture. This does not mean that this chapter was conceived as a logical theoretical development of the previous arguments. This is only partially the case: the structural parallel between the *qaṣīda* and the 'Abbasid mosque indicates that architecture was conceived as a deliberate programming of the spatial experience of the beholder. Buildings were viewed as specific instances of this programming, with the aim of leading the viewer through a carefully designed form towards a focal point. In this architectural journey, the gaze played a central role. Yet the spatial experience cannot be reduced to its visual aspect: in particular, the kinaesthetic feeling implied by motion through buildings, such as in the Balkuwara palace in Samarra, seems to have been an important factor in architectural planning.

The conclusion that the gaze was a central concern in 'Abbasid architectural planning contributed to my discussion of architectural creation and craftsmanship. Another important finding had already attracted my attention in this direction. An enquiry into the literary genre called *Ādāb al-Mulūk*, or rules of conduct of kings, based on the assumption that this genre must have reflected the political use of architecture, led me to discover an account by al-Tha'ālibi on al-Mutawakkil and the connection of architecture and desire. Based on this account and my conclusion about the role of the gaze in architectural planning, I then sought to analyse the similarity

between the desire for architecture and the desire for women and wine. The investigation of other literary sources (medical and theological) confirmed that the preoccupation with the gaze in its connection to desire were central to Islamic culture at the time.

The dialectic of desires (between designer, patron and viewers), and its consequent effects of creation, consumption, delight, destruction and death described in the last chapter, are reminiscent of what Oleg Grabar, referring to Freud, terms the ‘demonic force at work’⁴ in the work of art. Like many authors who are the first to discover a phenomenon, Grabar could not refrain from referring to myths. However, to his credit, he sensed the driving power of desire in artistic creation. It is also desire that, despite an understanding of the inescapable fate of all architectural works, led societies constantly to create new works and initiate new cycles of destruction.

This leads us to the discussion of the appearance of mystical views of art in the Islamic world. If, as this research consistently showed, the formation of Umayyad and ‘Abbasid architecture was in no way indebted to Sufism, it seems reasonable to assume that one hypothesis for the explanation of that phenomenon is Michel de Certeau’s theory of mysticism as subjective resistance to the overwhelmingly reductive character of rational thought.⁵ The triumph of the pious-minded theologians of the mid-ninth century, after Caliph al-Māmūn (d. CE 833) initiated the *grand Miḥna*, with their constraining ‘rationality’ and consequent regression of intellectual debates, seems to have increased the attraction of Sufi spirituality. It is therefore natural that, due to its connection to desire and its proximity to fable and fairytale, the domain of artistic creation became a terrain of investment for the mystics.

Notes

1. Introduction

1. Umberto Eco, *Art and Beauty in the Middle Ages*, translated by Hugh Bredin (New Haven: Yale University Press, 1986) p. 2.
2. The Moroccan Jewish community was, until the mid-1960s, a major cultural component of Moroccan society, both in urban and rural areas. It represented about one-sixth of the population. Despite the religious differences and some forms of spatial segregation in cities, the Jewish community was strongly integrated, and successfully secured a quasi monopoly on some crafts, such as jewellery, and professions, such as medicine, that made it crucial to social reproduction.
3. Oleg Grabar was among the first authors to assert this. See for instance his *Penser l'Art Islamique Aujourd'hui* (Paris: Albin Michel, 1996) p. 9.
4. Robert Hillenbrand, *Islamic Architecture, Form, Function and Meaning* (New York: Columbia University Press, 1994) p. 8.
5. On the refutation of this assertion see K. A. C Creswell, *Early Islamic Architecture* (Oxford: Clarendon Press, 1969) vol. 1, part 1, p. 147.
6. Oleg Grabar, *The Mediation of Ornament* (Princeton: Princeton University Press, 1992).
7. I must also mention that my interest in al-Jāhīz was inspired by Grabar's remark in an article about al-Azraqi that, 'for the long-range objective of understanding the ethos of a period [classical Islamic period]' authors like him [al-Jāhīz] should be investigated. 'Upon Reading al-Azraqi', *Muqarnas* (1985, vol. 3) pp. 1-7.
8. In an interesting essay Valerie Gonzalez writes: 'It is commonly thought that relative to the universal problem of representation raised by the arts in general in Muslim culture, inscriptions act as a substitute of the figurative image in the works of other great civilizations.' And challenging in her own way this view she shows that 'Rather than a scriptural version of visible figuration, Islamic calligraphy constitutes an autonomous aesthetic system which combines and articulates itself to another system.' Valerie Gonzalez, *Beauty and Islam: Aesthetics in Art and Architecture* (London: I.B.Tauris, 2001) pp. 95 and 110 respectively.
9. Gülru Necipoğlu, *The Topkapi Scroll: Geometry and Ornament in Islamic Architecture* (Santa Monica: The Getty Center for the History of Art and the Humanities, 1995) p. 83.
10. *Ibid.*, p. 83.

11. On 26 February 2001 the then Islamic Taliban government of Afghanistan promulgated an edict calling for the destruction of all statues in what claimed to be a strict interpretation of Islamic law's ban on idols. ('Because God is one God and these statues are there to be worshipped and that is wrong. They should be destroyed so that they are not worshipped now or in the future.' Declaration of the Mullah Omar, reported by the Taliban Bakhtar News Agency, quoted by CNN.) The intervention of international organizations and the outcry of scholars seemed to have been ignored by the Taliban, which proceeded to destroy the fifth-century Buddha statues carved out of the mountainside in Bamiyan. The event was widely covered by the news media; the *New York Times*, for instance, published articles on this subject in the issues of 2 and 3 March 2001. The political meaning of that event and its complex intricacies were brilliantly analysed in Finbarr Barry Flood, 'Between Cult and Culture: Bamiyan, Islamic Iconoclasm, and the Museum', *Art Bulletin*, vol. 84, no. 4, December 2002, pp. 641–59.
12. R. Garaudy, in *The Mosque, Mirror of Islam* (Paris: no publisher, 1985) p. 27 writes: 'The space of Muslim spirituality, which rejects all mediations between God and man, is a decentered space. Here spirituality is suggested not by organic integration but by addition and rhythmic repetition. The columns of a mosque ..., proliferate like a palm grove, always suggesting the unfinished nature of things. ... The major Revelation of the Qur'an is thus translated into stone.' To have a good view of the complexities of the meaning of Córdoba's mosque see for instance Nuha Khoury's 'The Meaning of the Great Mosque of Córdoba in the Tenth Century', *Muqarnas*, vol. 13, 1996, pp. 80–98.
13. See Janet L. Abu-Lughod, 'The Islamic City: Historic Myth, Islamic Essence, and Contemporary Relevance', *International Journal of Middle East Studies*, vol. 19, 1987, pp. 155–76.
14. Aga Khan Award for Architecture, *Toward an Architecture in the Spirit of Islam*, Seminar no. 1 (Gouvieux, France, 1978); Aga Khan Award for Architecture, *Conservation as Cultural Survival*, Seminar no. 2 (Istanbul, Turkey, 1978); Aga Khan Award for Architecture, *Architecture as Symbol and Self-Identity*, Seminar no. 4 (Fes, Morocco, 1979).
15. See Barbara Daly Medcalf (ed.) *Making Muslim Space* (Berkeley: University of California Press, 1996).
16. On this subject see Abu-Lughod, 'The Islamic City: Historic Myth', and Nezar al-Sayyad, *Cities and Caliphs: On the Genesis of Arab Muslim Urbanism* (Westport: Greenwood Press, 1991) chapter 2, pp. 13–41. Here is how al-Sayyad defines this stereotype: 'the typical Muslim city was identified as an inward-oriented city with a Friday mosque and a market-bazaar at its center. Its circulation network was made of narrow irregular streets leading to segregated residential quarters, and somewhere on the outskirts there was a citadel' (al-Sayyad, *Cities and Caliphs*, p. 13).

17. Oleg Grabar, *The Formation of Islamic Art* (New Haven London: Yale University Press, 1987) p. 180.
18. *Ibid.*, p. 209.
19. *Ibid.*, 210.
20. *Ibid.*, p. 209.
21. Roland Barthes, *Elements of Semiology*, translated by A. Lavers and C. Smith (New York: Hill & Wang, 1994) p. 31.
22. *Ibid.*, p. 196.
23. *Ibid.*, p. 198.
24. *Ibid.*, p. 198.
25. Hillenbrand, *Islamic Architecture*, pp. 24–6.
26. Theodor Adorno, *Philosophy of Modern Music*, translated by Anne G. Mitchell and Wesley V. Blomster (New York: The Seabury Press, 1973) pp. 32–4.
27. John Summerson, *The Classical Language of Architecture* (Cambridge: MIT Press, 1963).
28. Bruno Zevi, *The Modern Language of Architecture* (Seattle: University of Washington Press, 1978).
29. For a brief presentation of mannerism and classical principles, see Erwin Panofsky, 'Two Façade Designs by Domenico Beccafumi and the Problem of Mannerism in Architecture', in Erwin Panofsky, *Meaning in the Visual Arts* (New York: Doubleday Anchor Books, 1955) pp. 226–35.
30. The term 'architectural planner', rather than 'architect', seems better to designate the individual or the team of builders who presumably planned the monuments of the early Islamic period. It is indeed recognized that the term architect, with its old Western and/or modern connotations, can hardly denote what is known about the Islamic designers and builders of that period. See for example L. A. Mayer, *Islamic Architects and their Works* (Geneva: Albert Kundig, 1956), which despite its title indicates that the Western definition of an architect cannot be applied as it is to the architectural planners of Islamic countries of the past. This question will be further discussed in the last section of my book.
31. See Bruno Zevi, *Architecture as Space: How to Look at Architecture*, translated by J. A. Barry (New York: Horizon Press, 1978).
32. On the perception of design principles, see the essay on Le Corbusier's Modulor, 'A Review of Proportion', in Rudolf Arnheim, *Towards a Psychology of Art* (Berkeley: University of California Press, 1978).
33. Vitruvius, *The Ten Books on Architecture*, translated by Morris Hicky Morgan (New York: Dover Publications, Inc.) p. 175.
34. Similar adjustments were made in antiquity on sculptures intended to be put higher than eye level. In this case the lower parts of the body were made shorter than they ought. Somewhere E. Panofsky mentions this in reference to the Athena of Phidias, and another time in Plato's Sophistes:

- 'Not only those who produce some large work of sculpture or painting [use 'illusion']. For if they reproduced the true proportions of beautiful forms, the upper parts, you know, would seem smaller and the lower parts larger than they ought because we see the former from a distance, the latter from near at hand.' Erwin Panofsky, 'The History of the Theory of Human Proportions as a Reflection of the History of Styles', in Erwin Panofsky, *Meaning in the Visual Arts* (New York: Doubleday Anchor Books) p. 63n.
35. For further developments see Charles Jencks, *The Language of Postmodern Architecture* (York: Rizzoli/International, 1978).
 36. Ibn Khaldun, *The Muqaddimah*, translated by Franz Rosenthal (Princeton, NJ: Bollingen Series 43, Princeton University Press, 1967) vol. 3, p. 391.
 37. Paul Valéry, 'Mémoires d'un Poète', in Paul Valéry, *Oeuvres complètes* (Paris: Editions Gallimard, 1963) p. 1510. 'It is thus crucial that, in a poem, meaning must not be allowed to get the better of form and destroy it beyond return; it is in fact the return, the retention of form, or more precisely, reproduced as a unique and necessary expression of the state of mind produced in the reader; such is the surge of poetic force' (author's translation).
 38. Since this work might at times appear strongly critical of Oleg Grabar, I would like openly to acknowledge my tremendous debt to his work, which largely inspired my own.
 39. Bataille writes: 'It is more than a little strange that once conquests were consolidated the underlying Arab civilization, the negation of which had been a founding principle, recovered its vitality and continued much as before. Something of that *murwa* of the tribes, to which Mohammed opposed the rigours of the Koran, subsisted in the Arab world, which maintained tradition of chivalrous values in which violence was combined with prodigality, and love with poetry.' Georges Bataille, *The Accursed Share*, translated by Robert Hurley (New York: Zone Books, 1991) p. 90.
 40. Roman Jakobson, 'Closing Statements: Linguistics and Poetics', in Thomas A. Sebeok (ed.) *Style in Language* (New York: The Technology Press of MIT and John Wiley & Sons, Inc., 1960) p. 358.
 41. Rudolf Wittkower, *Architectural Principles in the Age of Humanism* (New York: W.W. Norton & Company, 1971).
 42. Jakobson, 'Closing Statements', p. 357.
 43. *Ibid.*, p. 371.
 44. Robert Venturi, *Complexity and Contradiction in Architecture* (Michigan: University of Michigan Press, 1990).
 45. Theodor Adorno, *Prisms*, translated by Samuel and Shierry Weber (Cambridge, MA: MIT Press, 1997) p. 86.
 46. The collaboration of foreign masters and artisans, who were summoned together from different parts of the Muslim empire, and the juxtaposition

- of imported elements of decoration, had already been noted as a feature of Umayyad architecture by Ettinghausen and Grabar, among others.
47. As Foucault says, power should be conceived ‘as a strategy, [and] that its effects of domination are attributed not to “appropriation”, but to dispositions, manoeuvres, tactics, techniques, functionings; that one should decipher in it a network of relations, constantly in tension, in activity, rather than a privilege that one might possess; that one should take its model as a perpetual battle rather than a contract regulating a transaction or the conquest of a territory. In short, this power is exercised rather than possessed; it is not the “privilege”, acquired or preserved, of the dominant class, but the overall sum of its strategic positions – an effect that is manifest and sometimes extended by the position of those who are dominated.’ Michel Foucault, *Discipline and Punish: The Birth of the Prison*, translated by Alan Sheridan (New York: Vintage Books, 1979) pp. 26–7.
 48. I borrow this approach from Michel Foucault, who first expressed it in relation to knowledge. He says: ‘Perhaps we should abandon the belief that power makes mad and that, by the same token, the renunciation of power is one of the conditions of knowledge. We should admit rather that power produces knowledge (and not simply by encouraging it because it serves power or by applying it because it is useful); that power and knowledge directly imply one another; that there is no power relation without the correlative constitution of a field of knowledge, nor any knowledge that does not presuppose and constitute at the same time power relations’ (Foucault, *Discipline and Punish*, p. 27).
 49. Philibert de l’Orme, ‘Dedicatoire to the *Traité d’Architecture*’, in Philibert de l’Orme, *Les Livres d’Architecture* (Paris: Leonce Laget, Libraire-Editeur, 1988) p. iiiii.
 50. In my opinion, there is a parallel between de l’Orme’s views and Keynes’s political economy. I think this is obvious enough and needs no further comment in the context of this work.
 51. On this subject, see for example Alexandre Papadopoulos, *Islam and Muslim Art*, translated by Robert Erich Wolf (New York: Harry N. Abrams, 1979). For a critical review of parallelism of philosophic systems and art in the Islamic world, see Grabar, *The Mediation of Ornament*, especially Chapter 1 and Conclusion.
 52. Grabar, *The Mediation of Ornament*, p. 244 note 14.
 53. The work in question is Louis Massignon, ‘Les Méthodes de Réalisation artistique de l’Islam’, in Louis Massignon, *Opera Minora*, edited by Y. Moubarac (Beirut: Dar al-Maarif) pp. 9–24. This was a lecture given at the Collège de France in 1920, first published in 1921, and republished in 1963 in Louis Massignon’s *Opera Minora*.
 54. Massignon (*Opera Minora*, p. 13) does not claim to have a precise definition of how Islamic theology was embodied in art. Many readers

- will recognize in what Massignon calls the negation of the 'permanence de la figure et de la forme' a well-known trope of the discourse on decoration in the Islamic world. This characteristic corresponds to what Oleg Grabar (*Formation of Islamic Art*, p. 188) describes as follows: 'the ornament can best be defined as a relationship between forms rather than as a sum of forms.'
55. Massignon, 'Les moyens de réalisation artistiques de l'Islam', p. 10. It is remarkable that since then, the same approach and the same arguments have constantly been used in works on the art of the Islamic world.
 56. Papadopoulo, *Islam and Muslim Art*, p. 25.
 57. According to this author, Muslims deny almost any artistic characteristic to architecture: 'Architecture, to Muslim eyes, appeared by comparison a dull art, above all because for them everything strictly architectural – the relationships of volumes and planes in space – was ignored in favour of whatever was utilized to "cloak" the walls, this being the only artistic interest they were willing to concede to the art of building' (Papadopoulo, *Islam and Muslim Art*, p. 27). I will discuss this problem later on in this work.
 58. See Richard Ettinghausen, *Arab Painting* (New York: Skira-Rizzoli, 1977) pp. 59–80.
 59. The change was limited to the name alone, and the date of the building remained unchanged, which made the inscription odd. Whereas al-Mamun ruled at the turn of the third century Hijra, the inscription reads: 'hath built this dome the servant of Allah 'Abd Allah the Imam al-Mamun Commander of the faithful in the year two and seventy – Allah accept of him' (Creswell, *Early Muslim Architecture*, vol. I, Part 1, p. 69).
 60. Eugène Viollet-le-Duc, *Dictionnaire raisonné de l'Architecture française du XIe au XVIe siècle* (10 vols, Paris: A. Morel, 1854–69) article 'Peinture'.
 61. An excellent example is the place afforded to the mosaics in all discussions of the Dome of the Rock. For a brief presentation of this case, see Chapter 1.
 62. See for example Ettinghausen's analysis of the ceiling paintings in the Capella Palatina in *Arab Painting*, pp. 44–50.
 63. Ḥunain Ibn Ishāq, *The Book of Ten Treatises on the Eye*, translated and edited by Max Meyerhof (Cairo: Government Press, 1928).
 64. On these issues, see Jacques Le Goff, *Pour un Autre Moyen-Age* (Paris: Gallimard, 1978).
 65. Ignaz Goldziher, *Introduction to Islamic Theology and Law*, translated by Andras and Ruth Hamori (Princeton: Princeton University Press, 1981) p. 43.
 66. In regard to this method Goldziher (*Introduction to Islamic Theology*, p. 39) says: 'It is easy to grasp that the points of view taken by this criticism were not the same as ours, and that our criticism will often raise doubts

- where its Muslim counterpart believes that it has found undoubtedly authentic material.'
67. In the introduction to one of his books, al-Jāhīz mockingly reports how mediocre books written and attributed by him to past authors were greatly praised by those who used to be his fiercest critics (al-Jāhīz, *al-Ma ḥāsin wa-l-aḥḍād*, Beirut: Al-Maktaba al-'asriya, 2003) pp. 18–19.
 68. I should mention that despite apparent similarities, my approach is at odds with that of Jo Tonna, 'The Poetics of Arab-Islamic Architecture', *Muqarnas*, vol. 7, 1990, pp. 182–97, both in terms of goals and methods. Jo Tonna applies the notion of 'architectural scansion' to incorporate profitably 'such values of traditional architecture as are seen to be still valid into the buildings of the future.' I, on the other hand, exclusively aim at indicating, and possibly demonstrating, the existence of structural parallels between two contemporary cultural phenomena, architecture and poetry. Thus, while Tonna predictably concludes that 'Islamic architecture' is 'a tragic discourse, a visual comment of the nature of existence', my approach is resolutely historical, and does not claim to do more than demonstrate that similar intellectual habits and processes, or a *modus operandi*, are at work in both the architecture of the Islamic world and Arabic poetics.
 69. Erwin Panofsky, *La Renaissance et ses Avants-Courriers dans l'Art d'Occident* (Paris: Flammarion, 1993).
 70. This is not to say that Umayyad architecture represents a rediscovery of ancient art, for it shows more points of continuity than discontinuity with the past. It is the new syntax that it demonstrates, and the relatively quick artistic changes that occurred with the advent of the 'Abbasids that pinpoints the existence of a conscious attitude, and perhaps of its possible change during that period.

2. Architecture and Meaning in the Theory of al-Jāhīz

1. Tabari, *Tārīkh* (Beirut: Dar al Kutub al-'Ilmiya) vol 1, p. 529. All translations from Arabic, unless otherwise specified, are mine.
2. On this use of the notion of beauty, see for instance Gonzalez, *Beauty and Islam*, Chapter 1, pp. 5–25. Another illustration of the epistemic break I am referring to is the change in the theory of language as manifested in the change of the organization of the Dictionary, or the *Muʿjam*, by the end of the tenth century AD (see next chapter).
3. Al-Jāhīz, *Kitāb al-Ḥayawān*, edited by Abdeslam Muhammad Harun (Beirut: Dar Al Jail, 1996) vol. 3, p. 299.
4. It is not easy to translate the word *al-bayān* into English. For instance, the *Hans Wehr Dictionary of Modern Written Arabic* gives among other translations the following: 'clearness, plainness, patency, obviousness; statement, declaration, announcement; manifestation; explanation, elucidation; illustration; information; news ... enumeration, index, list,

- eloquence', p.88. Of course this refers to the current use of the term, and does not make any etymological claim.
5. *Encyclopedia of Islam*, vol. 2, p. 386.
 6. Al-Jāhīz's world view is based on a philosophy of *al-kalām*, the word and speech. On the philosophy of *al-kalām* and the Mu'tazila see Henry Corbin, *Histoire de la Philosophie islamique* (Paris: Editions Gallimard, 1964); and Dominique and Janine Sourdel, *La Civilisation de l'Islam classique* (Paris: Arthaud, 1983).
 7. Al-Jāhīz, *Kitāb al-Ḥayawān*, vol. 1, p. 72.
 8. Al-Jāhīz does not explicitly say that 'Umar planned to unadorn the building but this is implicit in his account. Other sources do mention it explicitly.
 9. Al-Jāhīz, *Kitāb al-Ḥayawān*, vol. 1, pp. 56-7.
 10. *Ibid.*, p. 185.
 11. *Ibid.*, p. 44.
 12. Qur'an, S. Xxx, 22.
 13. The same conception is expressed in al-Jāhīz, *Al-Bayān wa al-Tabyīn* (Beirut: Dar Ihya' al-ulum, 1993) vol. 1, p. 89.
 14. Al-Jāhīz, *Kitāb al-Ḥayawān*, p. 33.
 15. Tabari, *Tarikh*, vol. 1, p. 529.
 16. This raises a rather complex issue about the relationship between speech (or *al-kalām*) and the voice, and about the faith of the rocks and the trees. Ibn Hicham reports the same event in his *as-Sayra an-Nabawiya*. See Fethy Benslama, *La Nuit brisée* (Paris: Ramsay, 1988) pp. 62-3.
 17. Al-Jāhīz, *Al-Bayān wa al-Tabyīn*, vol. 1, p. 84.
 18. This conception consequently gives a prominent position to reason in the philosophy of *al-kalām*. See Corbin, *Histoire de la Philosophie islamique*, p. 152).
 19. Al-Jāhīz gives only the four first components and then adds a definition of a fifth one considered of a different nature. However, in his later work *Al-Bayān wa al-Tabyīn* he simply states that *al-bayān* has five components. Here the fifth component is also called *nusba* (p. 84.) The reference to four components and a fifth one of a different nature is also found in the ninth century in Ḥunain Ibn Isḥāq's *The Book of the Ten Treaties on the Eye* who writes: 'the sense of vision is fiery and luminous, the sense of hearing air-like, the sense of taste water-like, the sense of touch earth-like and the sense of smell vapour-like. As there are four elements, a sense was created for each one of them by which each is recognized, i.e. the phenomena arising in them which are perceptible to the senses. And next to perception is that emanation which arises from vapour, and this is perceived in an unusual manner, as vapour is something halfway between air and water; so they become five (senses) without the existence of five elements' (Ibn Isḥāq, *The Ten Treaties*, p. 37).
 20. Al-Jāhīz, *Kitāb al-Ḥayawān*, vol. 1, p. 34.

21. Al-Jāhiz, *Al-Bayān wa al-Tabyīn*, p. 89.
22. Al-Jāhiz, *Kitāb al-Ḥayawān*, vol. 1, p. 33.
23. *Ibid.*, vol. 1, p. 47.
24. Qur'an, S.x. 5–6.
25. Al-Jāhiz, *Kitāb al-Ḥayawān*, vol. 1, p. 69.
26. Qur'an, S. xcvi, 1–5. In contrast to the orientalist tradition of translating *iqra* as 'recite', I translate it as 'read', which is supported by al-Jāhiz who quotes the verse in *Al-Bayān wa at-Tabyīn*, vol. 1, p. 87, while discussing the merits of writing and reading.
27. Qur'an, S. lxxviii, 1.
28. Al-Jāhiz, *Kitāb al-Ḥayawān*, vol. 1, p. 42.
29. Al-Jāhiz's description of the gifts of the hand is very brief, however. It recalls the brilliant 'Eulogy of the Hand' by Henri Focillon.
30. Qur'an, S. xx, 25–8.
31. Al-Jāhiz, *Kitāb al-Ḥayawān*, vol. 1, p. 111.
32. *Ibid.*, p. 113. Ibn 'Abd Rabbih reports that Suleiman Ibn 'Abd al-Malik, who was extremely jealous, once ordered the castration of a singer because he was convinced that the latter could seduce any woman he wished by his erotic voice. By that he intended to provoke a change in the voice of the singer and to deprive him of his seductive powers. See Ibn 'Abd Rabbih (1995) *Addur an-Nadid min al-'Iqd al-Farid*, edited by Mohamed Said al-'Aryān (Damascus: Talas) p. 751.
33. Michel Foucault, *The History of Sexuality: An Introduction*, vol. 1, translated by Robert Hurley (New York: Vintage Books, 1990) p. 57.
34. Al-Jāhiz, *Kitāb al-Ḥayawān*, vol. 1, p. 199.
35. *Ibid.*, pp. 108–9.
36. *Ibid.*, pp. 110–11.
37. *Ibid.*, p. 62.
38. *Ibid.*, vol. 1, p. 38.
39. *Ibid.*, vol. 1, p. 169.
40. *Ibid.*, vol. 3, p. 7.
41. *Ibid.*, vol. 1, p. 56.
42. This statement, which is inconsistent with the richly decorated Umayyad religious buildings, seems more to conform to the 'Abbasid attitude, and therefore points to a historical change in attitude of Muslims.
43. Al-Jāhiz, *Kitāb al-Ḥayawān*, vol. 4, pp. 191–2.
44. Ibn 'Abd Rabbih, *Addur an-Nadid min al-'Iqd al-Farid*, p. 743.
45. The word used by the author is *al-taqṭī'*, which is defined in *Lisān al-'Arab* as 'division of verses or weighing verses by metric parts and dividing them into metric feet'. See Ibn 'Abd Rabbih, *Addur an-Nadid min al-'Iqd al-Farid* vol. 8, p. 278.
46. *Ibid.*, p. 744.
47. In the passage treating of this opposition Ibn 'Abd Rabbih uses the word *'ām-ma (ahl al-Ḥijaz)*, which is generally opposed to *al-khāṣṣa*, the elite.

- The word *‘ām-ma* may thus mean the majority but also the common people as opposed to the elite.
48. The two sayings are quoted by Ibn ‘Abd Rabbih, *Addur an-Nadid min al-‘Iqd al-Farid*, p. 745.
 49. The slave was in the possession of Yazid who was so delighted by her voice that he offered to accomplish all her wishes. She asked him to make gifts to three of her friends. One of them asked Yazid to offer him three drinks and three songs by the slave. After the third song the man fell dead. It is only then that Yazid understood that that man was in love with the slave (Ibn ‘Abd Rabbih, *Addur an-Nadid min al-‘Iqd al-Farid*, p. 759).
 50. See Introduction; and Jean Sauvaget, ‘Esquisse d’une Histoire de la Ville de Damas’, *Revue des Études islamiques*, vol. 8, 1934, pp. 421–80.
 51. The story is reported by Ibn ‘Abd Rabbih, *Addur an-Nadid min al-‘Iqd al-Farid*, p. 753.
 52. *Ibid.*, pp. 748–9.
 53. Al-Jāhiz, *Kitāb al-Ḥayawān*, vol. 1, p.67.
 54. On this topic see Nuha Khoury, ‘The Dome of the Rock, the Ka’ba, and Ghumdan: Arab Myths and Umayyad Monuments’, *Muqarnas*, vol. 10, 1993, pp. 57–65; and G. R. D. King, ‘Cresswell’s Appreciation of Arabian Architecture’, *Muqarnas*, vol. 8, 1991.
 55. Al-Jāhiz, *Kitāb al-Ḥayawān*, vol. 1, p. 72.
 56. This is another argument in favour of the connection I assumed above between the debates about architecture and song.
 57. Adonis, *An Introduction to Arabic Poetics*, translated by Catherine Cobham (Austin: University of Texas Press, 1990) p. 15.
 58. Al-Jāhiz, *Kitāb al-Ḥayawān*, vol. 1, p. 73.
 59. See Chapter 1.
 60. On the importance and meaning of ruins see Chapter 4, Architecture and Myth.
 61. Al-Jāhiz, *Kitāb al-Ḥayawān*, vol. 3, p. 140. The story of the successive reconstructions of the *ka’ba*, and the awareness that its original shape was not cubic show that *al-‘aqd*, geometricism, triumphed over the supporters of the original form. See Creswell, *Early Muslim Architecture*, vol. 1, part 1.
 62. Hillenbrand, *Islamic Architecture*, pp. 12–14.
 63. Here is how Roland Barthes (in *Elements of Semiology*, pp. 48–9) defines signification. ‘Signification can be conceived of as a process; it is the act which binds the signifier and the signified, an act whose product is the sign. This distinction has only a classifying (and not phenomenological) value: firstly, because the union of signifier and signified, as we shall see, does not exhaust the semantic act, for the sign derives its value also from its surroundings; secondly, because, probably, the mind does not proceed, in the semantic process, by conjunction but by carving out. And indeed signification (semiosis) does not unite unilateral entities, it does

- not conjoin two terms, for the good reason that signifier and signified are both at once term and relation ... signifier and signified have a floating relationship and coincide only at certain anchorage points.'
64. See Chapter 4, 'Al-Jāhiz in the Mosque at Damascus'.
 65. On this subject see Georges Duby, *Saint Bernard: L'Art cistercien* (Paris: Editions Flammarion, 1979); and Erwin Panofsky, *Abbot Suger on the Abbey Church of St Denis and its Art Treasures* (Princeton, NJ: Princeton University Press, 1946).
 66. On this subject see Jencks, *The Language of Postmodern Architecture*, Chapter 1.
 67. M. Izeddin, 'Un prisonnier arabe à Byzance au IXe siècle, Haroun Ibn Yahya', *Revue des Etudes islamiques*, vol. 15, 1946, p. 51.
 68. See the comments on this issue by Izeddin, *ibid.*, especially note 2, p. 42.

3. Architecture and Poetics

1. Ibn Qutayba, *Kitāb al-Shi'r wa-l-Shu'ara*, edited by M. J. de Goeje (Leiden: E. J. Brill, 1904) pp. 28–9.
2. Erwin Panofsky, *Gothic Architecture and Scholasticism* (New York: Meridian, 1985) p. 27.
3. Talking of 'significant form' Clive Bell makes a comparable statement: 'It is years since I met anyone, careful of his reputation, so bold as to deny that the literary and anecdotic content of a work of visual art, however charming and lively it might be, was mere surplusage.' Quoted in Jacques Barzun, *The Use and Abuse of Art* (Washington, DC: National Gallery of Art) p. 102.
4. See Michel Foucault, *Ceci n'est pas une Pipe* (Paris: Editions Gallimard, 1982).
5. E. H. Gombrich, *The Story of Art* (New York: Phaidon Press, 1978) p. 20.
6. Qays ibn al-Mulawwah, *Diwan Majnūn Layla*, edited by Abdassattar Ahmad Farraj (Cairo: Maktabat Masr) pp. 73–4. Also quoted in Anas Badiwi, Hamdu Tammas and Hassan Attibi, 2005, *Rawai' al-Shi'r al-Umawi* (Beirut: Dar El-Marefah, 2005) pp.64–5.
7. As I indicated in my introduction, Louis Massignon played a crucial role in most of the works on architecture and Islam. Terry Allen characterizes these works simply as nonsense. He writes: 'Massignon's essentially Romantic viewpoint is responsible at second and third hand for much of the nonsense that has been written, even at the scholarly level, about "the spirit of Islamic art".' Terry Allen, *Five Essays on Islamic Art* (Sebastopol, CA: Sollipsist Press, 1988) pp. 1–2.
8. Oleg Grabar, 'The Mosque', in Markus Hattstein and Peter Delius (eds), *Islam, Art and Architecture* (Königswinter: Könemann, 2004).
9. See Massignon, 'Les moyens de réalisation artistique de l'Islam', pp. 9–24.
10. Oleg Grabar, *Formation of Islamic Art*, p. 192.
11. Panofsky, *Gothic Architecture and Scholasticism*, pp. 20–21.

12. Pierre Bourdieu, 'Postface' to Erwin Panofsky, *Architecture gothique et Pensée scolastique* (Paris: Editions de Minuit, 1975).
13. Barzun, *The Use and Abuse of Art*, pp. 101–2.
14. This is, for instance, the case with Nader Ardalan and Laleh Bakhtiar, *The Sense of Unity: The Sufi Tradition in Persian Architecture* (Chicago: University of Chicago Press, 1973); Titus Burckhardt, *Art of Islam: Language and Meaning*, translated from French by Peter Hobson (London: Islamic Festival trust Ltd, 1976); and Tonna, 'The Poetics of Arab-Islamic Architecture'. The influence of Louis Massignon was determinant in that regard. See Grabar, *Formation of Islamic Art*, pp. 191–2.
15. This misconception was strongly denounced by modern art, but also by film makers, novelists, and literary critics such as Robbe-Grillet and Roland Barthes.
16. Garth Fowden, *Qusayr 'Amra: Art and the Umayyad Elite in Late Antique Syria* (Berkeley: University of California Press, 2003) p. 309. In this very inspired book Garth Fowden notes that, in the Umayyad period, the ideal sequence of the Arabic ode 'was extremely familiar, and perhaps not entirely surprisingly, turns out to be a felicitous organizing principle for the description of Qusayr 'Amra'. He further says: 'Poetry provides, then, a key to understanding Qusayr 'Amra. By the same token, the bathhouse furnishes a hoard of images illustrative of the *qaṣīda*' (pp. 86 and 87 respectively). But because the author believes, as he says on p. 86, that this is merely a 'happy coincidence', and above all because he is mostly interested in the themes of Qusayr 'Amra frescoes and those of the *qaṣīda* he does not seem fully to apprehend all the theoretical implications of what he so brilliantly, but only intuitively, grasped. Here I should mention that my own work on these issues predates the publication of Fowden's book, and was developed earlier in my Ph.D. dissertation, *al-Bayān wa l-Bunyān*, presented at the University of California, Berkeley in May 2001.
17. See Ahmad Amin, *Ḍuḥā al-Islam* (Cairo: Maktabat an-Nahda al-Masria, 1974) vol. 2, pp. 263–4.
18. For a brief presentation of this debate see 'Abd Allah Darwish, 'Introduction', in Ibn Ahmad al-Khalil, *Kitāb al-'Ayn*, edited by 'Abd Allah Darwish (Baghdad: Dā'irat al-Shu'ūn al-Thaqāfiya wa al-Nashr, 1967).
19. *Ibid.*, p. 65. It should be noticed that al-Khalil does not use the word *sawt*, voice/sound, but rather *al-ḥarf*, the letter, when he visibly means the sound. To be faithful to his conception I will therefore use the Arabic *ḥarf*, or simply letter. Besides, the observations he makes in support of his phonetic order seem to be almost totally accurate, and comparable with those of modern phonology. For these questions see the introduction to *Kitāb al-'Ayn* by Mahdi al-Makhzumi and Ibrahim as-Samarra'i (Baghdad: Dar ar-Rachid, 1980).
20. Al-Khalil, *Kitāb al-'Ayn*, edited by Darwish, p. 96.

21. Ibid., p. 68.
22. Ibid., p. 181.
23. Al-Khalil, *Kitāb al-'Ayn*, edited by Makhzoumi and as-Samarra'i, vol. 8, pp. 379–84.
24. 'Most of these are neglected' says al-Khalil. Al-Khalil, *Kitāb al-'Ayn*, edited by A. Darwish, p. 66.
25. *Al-ḥarf al-muḍa'af* is a double letter, the first being quiescent and the second moving.
26. See the introduction to al-Khalil, *Kitāb al-'Ayn*, edited by Makhzoumi and as-Samarra'i, p. 9.
27. Al-Khalil, *Kitāb al-'Ayn*, edited by Darwish, p. 60.
28. Like with the combination of *d* and *k*, which is usually unpleasant but is acceptable in *dakdakatu an-nisā'*. 'Repetition allows excess', it allows 'meagre and fat' says al-Khalil, *Kitāb al-'Ayn*, edited by Darwish, p. 63.
29. Al-Khalil, *Kitāb al-'Ayn*, edited by Darwish. p. 58.
30. These historic conditions seem to connect the theoretic development of Arabic poetics with the advent of Islam. The word *ash-shu'ūbiya* (from *shu'ūb*, plural *sha'b* or people) originally, that is during the 'Abbasid Empire from the late eighth century AD onwards, means Persian cultural resistance to Arab discrimination and claim of superiority, and is based on Qur'anic egalitarianism.
31. Ibn Khaldun, *The Muqaddimah*, vol. 3, p. 391.
32. Al-Jāḥiẓ, *Kitāb al-Ḥayawān*, vol. 1, p.75. The same argument is developed in another form in al-Jāḥiẓ, *Al-Bayān wa al-Tabayīn*, Part 2, pp. 722–3, when answering to *ash-shu'ūbiya* the author argues that poetry is innate to Arab Bedouins.
33. Gotthold Weil, *Encyclopedia of Islam*, article "Arūd", vol. 1, p. 667.
34. 'Both al-Hariri and Ibn Khallikan report that al-Khalil had noticed the different rhythms produced by the hammering in different copper-workshops in the bazaar in Basra, and that this gave him the idea of developing a science of metre' (Weil, "Arūd", p. 669) It is remarkable that legends about aesthetic theories inspired by hammering go back to antique times. Thus 'Pythagoras had observed that a blacksmith's hammers struck his anvil with different notes, and that this difference was proportional to the weight of the hammers' (Eco, *Art and Beauty in the Middle Ages*, p. 31). It would be interesting to see if there is any historical connection between the two legends, and to contrast epistemologically the conclusions drawn by the authors from a similar observation.
35. It is believed that al-Khalil described only 15 of them, and that the 16th was added later.
36. Weil, "Arūd", p. 670.
37. Ibid., p. 669.
38. Ibid., p. 671.
39. This was done by applying the rules of *ziḥāfāt* and *'ilal*, alterations and

changes in the sequence of consonants, to modify the normal form of the feet of a metre. Here is how Weil describes them: 'The last foot of the first hemistich (*al-'arūd*, pl. *a'ārid*) and the last foot of the second hemistich (*al-ḍarb*, pl. *ḍarūb*), that is to say, the ends of the two halves of the line, suffer most deviations. The terms for these two vulnerable parts of the verse are definite; the terms for the other feet vary and are usually given by the collective name *al-ḥashw* ('stuffing'). By analogy, one also distinguishes two groups of deviations, the *ziḥāfāt* and the *'ilal*. The *ziḥāfāt* ('relaxations') are, as the name suggests, smaller deviations that occur only in the *ḥashw* parts of the line in which the characteristic rhythm runs strongly, and their effect is a small change in the weak *asbāb*-syllables. As accidental deviations, the *ziḥāfāt* have no regular or definite place, they just appear occasionally in the feet. By contrast, there are the *'ilal* ('diseases', 'defects') that appear only in the last feet of the two halves of the verse, and there, as their name suggests, they cause considerable change compared with the normal feet. They alter the rhythmic end of the line considerably, and are thus clearly distinct from the *ḥashw* feet. As rhythmically determined variations, the *'ilal* do not just appear occasionally but have to appear regularly, always in the same form, and in the same position in all the lines of the poem' (Weil, 'Arūd', p. 671). For further developments, see Ibn 'Abd Rabbih, *Addur an-Nadid min al-'Iqd al-Farid*, pp. 693–9. It is interesting that the vital source of change and variation is considered an *'illa* (disease) and still viewed as a necessary poetic device.

40. Darwish, 'Introduction', p. 34.
41. Adonis, *An Introduction to Arab Poetics*, p. 27. For further developments on this topic see Chapter 1 of this book.
42. See al-Jāḥiẓ's passage on *ash-shu'ūbiya* mentioned in note 32 above.
43. Lane quoted by Goldziher, *Introduction to Islamic Theology*, p. 667.
44. There is also a view of language as composed of noble words and vile ones. 'Speech is of different levels [of quality] like people themselves are of different levels.' But, says al-Jāḥiẓ, this does not imply 'that vile words are in formal connection (*mushākilun*) with vile meanings. For sometimes, vile [words] may be needed, and they may procure more pleasure than great eloquence, and noble words with liberal meaning' (al-Jāḥiẓ, *Al-Bayān wa at-Tabayīn*, p. 148).
45. Adonis, *An Introduction to Arab Poetics*, pp. 29–30.
46. On this topic see *ibid.*, Chapter 3, pp. 55–74.
47. Al-Jāḥiẓ, *Kitāb al-Ḥayawān*, vol. 7, p. 165.
48. Panofsky, *Gothic Architecture and Scholasticism*, p. 35.
49. *Ibid.*, p. 64.
50. Mary Catherine Bateson, *Structural Continuity in Poetry: A Linguistic Study of Five Pre-Islamic Arabic Odes* (Paris: Mouton & Co., 1970) p. 34.
51. Ibn Manẓur, quoted by Abdefattah Kilito, *L'auteur et ses Doubles* (Paris:

- Editions du Seuil, 1985) p. 21, cited and translated by Stefania Pandolfo, *Impasse of the Angels: Scenes from a Moroccan Space of Memory* (Chicago: University of Chicago Press, 1997) p. 285.
52. Pandolfo, *Impasse of the Angels*, p. 22 (for translation) or Kilito, *L'auteur et ses Doubles*, p. 286.
 53. Perhaps we should interpret the fashion of Arabic among the Spanish Christians of the ninth century in connection with this aesthetic view of Arabic and its formalism. Such an interpretation is suggested by Alvaro's lament: 'My fellow-Christians delight in the poems and romances of the Arabs; they study the works of Mohammedan theologians and philosophers, not in order to refute them, but to acquire a correct elegant Arabic style. Where today can a layman be found who reads the Latin commentaries on Holy scriptures? Who is there that studies the Gospels, the Prophets, the Apostles? Alas! the young Christians who are most conspicuous for their talents have no knowledge of any literature or any language save Arabic; they read and study with avidity Arabian books; they amass whole libraries of them at a vast cost, and they everywhere sing the praises of Arabic lore. On the other hand, at the mention of Christian books they disdainfully protest that such works are unworthy of their notice. The pity of it! Christians have forgotten their own tongue and scarce one in a thousand can be found able to compose in fair Latin a letter to a friend! But when it comes to writing Arabic, how many there are who can express themselves in that language with the greatest elegance, and even compose verses which surpass in formal correctness those of the Arabs themselves.' Quoted in G. E. Von Grunebaum, *Medieval Islam: A Study in Cultural Orientation* (Chicago: University of Chicago Press, 1966) pp. 57–8 (italics are mine). Cited also by E. Lévi-Provençal, *La Civilisation arabe en Espagne* (Paris: Maisonneuve et Larose, 1961) pp. 108–9.
 54. Jamal Eddine Bencheikh, *Poétique arabe: Essai sur un Discours critique* (Paris: Stock, 1998) p. 54.
 55. Ibn Khaldun, *The Muqaddimah*, abridged version translated by Franz Rosenthal (Princeton, NJ: Bollingen Series, Princeton University Press, 1989) p. 448. Ibn Khaldun is of course of a later period than that under consideration in this work but on this particular matter he seems to be faithful to the classical views. To make clear his notion of method of poetry he writes: '(Poetical method) is used to refer to a mental form for metrical word combinations which is universal in the sense of conforming with any particular word combination. This form is abstracted by the mind from the most prominent individual word combinations and given a place in the imagination comparable to a mould or a loom. World combinations that the Arabs consider sound, in the sense of having the (correct) vowel endings and the (proper) style, are then selected and packed by (the mind) into (that form), just as the builder does with the

- mould or the weaver with the loom. Eventually, the mould is sufficiently widened to admit the word combinations that fully express what one wants to express. It takes on the form that is sound in the sense (that it corresponds to) the Arabic linguistic habit' (Ibn Khaldun, *The Muqaddimah*, abridged version, p. 445).
56. 'Abd al-Malik ibn Qurayb al-Aṣma'ī, *Fuḥūlat al-Shu'arā*, edited by Mohammed 'Abd al-Mun'im Khafaji and Taha Mohammed al-Zini (Cairo: al-Natba'ah al-muniriyyah bi al-Azhar, 1953) p. 38.
 57. Ibn Qutayba, *Kitāb al-Shi'r wa-l-Shu'ara*, p. 63.
 58. Ibid., p. 64.
 59. Bencheikh (*Poétique arabe*, p. 58) writes: 'La faculté poétique est une *malaka*, disposition stable, *habitus*.'
 60. Al-Khalil (*Kitāb al-'ayn*, edited by Darwish, p. 52) says that he wanted to define Arabic in his entirety, 'arāda an ya'rifa madāra kalāma al-'arabi wa alfāḍihim'.
 61. Bateson, *Structural Continuity in Poetry*, p. 32.
 62. The word *qaṣīda* 'is derived from the root *qaṣada*, 'to aim at', for the primitive *qaṣīda* was intended to eulogize the tribe of the poet and denigrate the opposing tribe' (F. Krenkow, 'Qaṣīda', *Encyclopedia of Islam*, new edition, vol. 4, p. 713).
 63. Ibn Qutayba, *Kitāb al-Shi'r*, p. 15.
 64. Bencheikh, in *Poétique arabe*, supports the four parts composition of the *qaṣīda*. On the contrary some authors, like F. Krenkow ('Qaṣīda'), do not consider that the *qaṣīda* is composed of four parts but only of three. They argue that the *dhikr* and the *nasīb* are but two components of the prologue.
 65. Bencheikh asserts that in spite of the absence of evident ties between its parts a *qaṣīda* is a meaningful movement characterized by the continuity of this movement through the entire poem (Bencheikh, *Poétique arabe*, p. 118).
 66. Adonis emphasizes that 'the fact that each verse (*bayt*) in the *qaṣīda* is an independent unit relates to the demands of recitation and song and their effects on the listener and not, as some people believe, to the nature of the Arab mind, which they claim is preoccupied with the parts at the expense of the whole' (Adonis, *An Introduction to Arab Poetics*, p. 18).
 67. On the prohibition of enjambement, see Bateson, *Structural Continuity*, pp. 32-3.
 68. Ibn Qutayba, *Kitāb al-Shi'r*, p. 16.
 69. André Malraux, *Les Voix du Silence* (Paris: Gallimard, 1951) p. 624.
 70. Papadopoulos, *Islam and Muslim Art*, p. 27.
 71. Grabar, *Formation of Islamic Art*, p. 179. A similar view is developed in *The Mediation of Ornament*, where this phenomenon is called 'visual obfuscation', 'whereby a concrete message comparable in intensity to the procession of the Ara Pacis or to the apostles at the entrance of Amiens

- is being hidden in an ornamental pattern, with the intent that its intensity be diminished or only recognized by those who, as our bureaucracy puts it, need to know' (Grabar, *The Mediation of Ornament*, p. 33).
72. Grabar, *The Mediation of Ornament*, p. 180 (italics are mine).
 73. Grabar, *Formation of Islamic Art*, p. 180.
 74. In *The Mediation of Ornament* (p. 37) Grabar asserts: 'The ornament at Mshatta is *terpno poetic*, a neologism to mean "providing pleasure", and, until the contrary is proved, this is all it is.' For the invitation à la rêverie, see Gaston Bachelard, *The Poetics of Space*, translated by Maria Jolas (Boston: Beacon Press, 1969) especially Chapter 6, pp. 136–47.
 75. Quoted in Bachelard, *The Poetics of Space*, pp. 145–6, translation modified.
 76. *Ibid.*, p. 146.
 77. Ibn Khaldun, *The Muqaddimah*, abridged version, pp. 443–4.
 78. Ibn Qutayba, *Kitāb al-Shi'r*, pp. 25–6.
 79. Another author, Ibn Tabataba (d. 322 AH/AD 934), develops the same view in very precise terms. See Bencheikh, *Poétique arabe*, pp. 119–20.
 80. On this issue, see Bencheikh's reflections in *ibid.*, pp. 119–26.
 81. Ernst Herzfeld, *Die Ausgrabungen von Samarra/Erster Band, Der Wandschmuck der Bauten von Samarra und seine Ornamentik* (Berlin: Dietrich Reimer, 1923).
 82. Eva Baer, *Islamic Ornament* (New York: New York University Press, 1998) p. 129.
 83. On this issue see Grabar, *Formation of Islamic Art*, pp. 182–4.
 84. *Ibid.*, pp. 193–4.
 85. See Baer, *Islamic Ornament*.
 86. This is the preferred explanation of Eva Baer who cites the following text by al-Birūni in support of her view: 'if kings have no other way to increase their power they embellish themselves with sumptuous jewellery so that they will be honoured by the people since they adore wealth and yearn for it' (Baer, *Islamic Ornament*, p. 126). The equivalence between sumptuousness and closeness, however, remains to be proved.
 87. Eva Baer ascribes three functions to geometry in ornament. She writes: 'First, it served as a grid into which other forms were interwoven. Secondly, it was one of the means of creating coherence and infinity; and thirdly, it was a decisive factor in the composition of overall patterns' (Baer, *Islamic Ornament*, p. 125).
 88. Jo Tonna has already pointed to the similarity between architectural compositions and poetic metres. He writes: 'Metric patterns in architecture are analogous to the steps of a dance, the orderly succession of stressed and unstressed syllables in poetry, and the alternation of accented and non accented sounds in music' (Tonna, 'The Poetics of Arab Islamic Architecture', p. 190).
 89. Baer, *Islamic Ornament*, p. 125.

90. Von Grunebaum writes: 'Contemporary with the introduction of Arabic coinage was that of Arabic as the official language. A bilingual Greek–Arabic document appears in Egypt as early as 643, but Greek and Coptic remained the languages of the administration; in Iraq, Pahlavi, the 'Middle Persian' governmental language, was taken over together with Persian methods of administration. The assimilation of the foreign speaking clerks, perhaps also the recruitment of Arabic-speaking staff and the increasing self-consciousness of the public service made the linguistic reform necessary and possible. That non-Arabic and bilingual documents still occur after the official introduction of Arabic (in Damascus in the year 705) is not surprising in view of the viability of Greek, and particularly of Coptic in Egypt. It fits in with the picture of these reforms that the vulgate form of Arabic commonly called "Middle Arabic" should be traceable in towns like Alexandria by about 700; in other words, by 700 Arabic had already become the business language' (G. E. Von Grunebaum, *Classical Islam: A History, 600 AD–1258 AD*, translated by Katherine Watson (Chicago: Aldine Publishing Company) p.75). On the great Umayyad building programmes and the possible existence of a larger cultural dynastic programme, see also Flood, 'Between Cult and Culture'.
91. On this issue see Grabar, *Formation of Islamic Art*, pp. 89–94.
92. See the word *handasa* in al-Khalil, *Kitāb al-'Ayn*, edited by al-Makhzumi and as-Samarra'i, vol. 4, p. 120. It is worth noticing that at this stage the *muhandis* is defined only as 'he who calculates the sizes of canals, and the locations where they must be dug'.
93. Allen, *Five Essays on Islamic Art*, p. 13. It is interesting to notice that Allen's definition of the arabesque as a system, achieved in the tenth century, in which 'the stems of the view were given the shape of what had formerly been a nonvegetal pattern, or conversely, the geometric framework came to life and the vine leaves sprouted directly from it' (p. 5) and its characterization by an 'emphasis on the method of construction of the vegetal ornament rather than on its literal representation of vegetation' (p. 13) recall the theory of language of al-Khalil. In the theory of the latter too the emphasis was put on the method of construction of the words rather than on their meaning. It is not by accident that al-Khalil probably composed only the introduction to *Kitāb al-'Ayn*, and asked his pupil al-Layt to complete the book.
94. K. A. C. Creswell, *A Short Account of Early Muslim Architecture* (New York: Penguin Books, 1958) p. 95.
95. Some of these poetic games are still popular in the middle East, and even in southern Morocco among the descendants of Arabian villages. In Morocco *al-la'b*, literally the game or play, is a poetic joust opposing two groups of young men from different tribes. Based on strict rules these jousts, which last the entire night, are practised very often and on differ-

- ent occasions. For more details see Pandolfo, *Impasse of the Angels*, Chapter 13.
96. Bateson, *Structural Continuity in Poetry*, p. 35.
 97. I intentionally avoid the use of the term 'architect', for its modern connotations are inappropriate in the context of early Islamic societies.
 98. Hillenbrand, *Islamic Architecture*, pp. 397–8.
 99. Tonna, 'The Poetics of Arab-Islamic Architecture', pp. 190, 195.
 100. There are indeed more arguments against this view. As Oleg Grabar writes: 'Many arguments of logic and of fact exist against this immediate interpretation of geometry, however appealing it is to a curious mixture of Western orientalists and Islamic fundamentalists. ... There does not exist, to my knowledge, a single instance justifying the view that the Muslim community, the *umma*, as opposed to individual thinkers, understood mathematical forms as symbolizing or illustrating a Muslim cosmology. Furthermore, we have no information to the effect that viewers of complex designs on walls, ceiling, or floors interpreted them in the abstract and schematic formulas of the orderly sketches needed by the artists or artisans to make their designs. Finally, although it has been shown that at least contemporary artisans are well aware of the complex technology of their design, I do not know of many instances of a spectator or viewer being equally informed' (Grabar, *The Mediation of Ornament*, p. 151).
 101. Jean Sauvaget, *La Mosquée omeyyade de Médine* (Paris: Vanoest, 1947).
 102. The stories about the Christian masons working in the construction of the mosque who tarnished the mosque of the prophet may be good indicators of the reaction against the introduction of a Christian architectural symbolic feature in a mosque. See al-Muqaddasi, *Kitāb Aḥsan al-Taqāsīm*, edited by M. J. de Goeje (Leiden: E. J. Brill, 1906) p. 81.
 103. On these issues see Grabar, *Formation of Islamic Art*, Chapter 15. This hypothesis has been strongly criticized by Jeremy Johns, 'The "House of the Prophet" and the Concept of the Mosque', in J. Johns (ed.) *Bayt al-Maqdis: Jerusalem and Early Islam* (Oxford: Oxford University Press) pp.59–112.
 104. Grabar, *Formation of Islamic Art*, pp. 111–12. Creswell also noticed that 'the first mosque, according to Baladhuri, was simply marked out (*ikhṭaṭṭa*) and the people prayed there without any building. According to another version, also given by Baladhuri, it was enclosed by a fence of reeds (*qaṣāb*)' (Creswell, *Early Muslim Architecture*, vol. 1, part 1, p. 22).
 105. Jeremy Johns, *Bayt al-Maqdis: Jerusalem and Early Islam* (Oxford: Oxford University Press) vol. 2, p. 88.
 106. Hillenbrand, *Islamic Architecture*, p. 139.
 107. Creswell (*A Short Account of Early Muslim Architecture*, p. 415) writes: 'in the early mosques – at Córdoba in 787, Qairawan in 836, and Tunis in 864 – the *ṣahn*, except for the sanctuary on the *qibla* side, was not surrounded by *riwaqs*.'

108. Creswell, *A Short Account of Early Muslim Architecture*, pp. 58–9. It is equally legitimate, however, to assume that al-Walīd built the third minaret of the mosque of Damascus, as Hillenbrand (*Islamic Architecture*, pp. 137–8) argued.
109. See Creswell, *A Short Account of Early Muslim Architecture*, p. 293.
110. *Ibid.*, pp. 361–2.
111. John D. Hoag, *Islamic Architecture* (New York: Electa/Rizzoli, 1987) p. 29.
112. Ibn Qutayba, *Kitāb al-Shi'r*, p. 15.
113. On these associations, see Grabar, *The Formation of Islamic Art*, p. 115; and Hillenbrand, *Islamic Architecture*, pp. 86–7.
114. Ernst Herzfeld quoted in Creswell, *A Short Account*, p. 365.
115. Creswell, *A Short Account*, p. 366.
116. Hillenbrand, *Islamic Architecture*, p. 404. It should be mentioned that the impact of the increasing formality of the court can be perceived earlier in Umayyad architecture, and that architectural directionality is already present, for instance, in the composition of the palace at Mshatta.
117. On this issue see Sauvaget, *La Mosquée omeyyade de Médine*, who was the first to make the parallel between mosque and palace architecture; and Estelle Whelan, 'The Origins of the Miḥrab Mujawwaf: A Reinterpretation', *International Journal of Middle East Studies*, vol. 18, no. 2, 1986, pp. 205–23.
118. Grabar, *The Formation of Islamic Art*, p. 117.
119. *Ibid.*, p. 118.
120. R. W. Hamilton, *Khirbat Al Mafjar: An Arabian Mansion in the Jordan Valley*, with a contribution by Oleg Grabar (Oxford: Clarendon Press, 1959) p. 41.
121. Michel Ecochard, *Filiation des Monuments grecs, byzantins et islamiques: une Question de Géométrie* (Paris: Librairie orientaliste Paul Geuthner, 1978) pp. 13–40.
122. On this issue see the extensive observations of Creswell, *Early Muslim Architecture*, in particular the sections on the architectural origins of Umayyad architecture in Part I. See also the brief and suggestive comments of Robert Hillenbrand, *Islamic Art and Architecture: The World of Art* (New York: Thames & Hudson) pp. 28–32; and Ecochard, *Filiation des Monuments grecs*.

4. Architecture and Myth

1. The body of tales discussed in this chapter constitutes what is usually referred to as the myth of a grandiose Arabian architecture. Strictly speaking, these tales are foreign to the anthropological notion of myth. Indeed, these tales may be better defined as legends for they do not possess some of the main characteristics of myths such as prohibition. However, because most architectural historians employ the two terms interchangeably, and as the anthropological difference between myth

- and legend does not impact on my analysis, I too shall refer to these stories as both myths and legends.
2. In the third half of the verse, the word *hijjatun* is translated as 'year'. It seems that al-Jāhīz is exaggerating when he states that the architect worked on the building for 70 years. Other chroniclers have quoted this poem mentioning only 20, or 60 years. Regardless, variety and exaggeration are in harmony with the mythical nature of these narratives.
 3. Al-Jāhīz, *Kitāb al-Ḥayawān*, vol. 1, p. 23.
 4. Reported by Ibn Sa'd. Quoted Hoag, *Islamic Architecture*, p. 10.
 5. King, 'Creswell's Appreciation of Arabian Architecture', pp. 94–102.
 6. 'It would be interesting sometime to investigate archaeologically the Iraqi monuments of the Lakhmids whose location seems known, or the impressive ruins of Yemen.' Grabar, *The Formation of Islamic Art*, p. 76. On the excavations, see Brian Doe, *Monuments of South Arabia* (New York: Falcon-Oleander, 1983); David Talbot Rice, 'The Oxford Excavations at Hira', *Ars Islamica*, vol. 1, pp. 51–73.
 7. Oleg Grabar, *The Formation of Islamic Art*, p. 77. However, Grabar immediately casts doubt on the possibility of 'an obliteration of a collective memory of forms when so many of them were the very things that surrounded and accompanied the life of the whole collectivity'.
 8. Khoury, 'The Dome of the Rock, the Ka'ba, and Ghumdān', p. 62.
 9. Jean Halévy, 'Khawarnak et Sinimmar', *Revue Sémitique* (Paris, edited by Ernest Leroux) vol. 15, 1907, p. 102.
 10. *Ibid.*, pp. 101–7.
 11. *Ibid.*, p. 103.
 12. Claude Lévi-Strauss, 'The Story of Asdival', in Claude Lévi-Strauss, *Structural Anthropology*, translated by Monique Layton (Chicago: University of Chicago Press, 1983) vol. 2, pp. 172–3.
 13. See Claude Lévi-Strauss, *Myth and Meaning* (New York: Schocken Books, 1979); and John Middleton (ed.) *Myth and Cosmos: Reading in Mythology and Symbolism* (New York: Natural History Press, 1967).
 14. Claude Lévi-Strauss, 'Reflections on a Work by Vladimir Propp', in Claude Lévi-Strauss, *Structural Anthropology*, translated by Monique Layton (Chicago: University of Chicago Press, first published 1976) vol. 2, pp. 137–8.
 15. Lévi-Strauss continues: 'However, this correspondence should not always be conceived as a kind of mirror-image, it can also appear as a *transformation*. If the problem is presented in "straight" terms, that is, in the way the social life of the group expresses and tries to solve it, the overt content of the myth, the plot, can borrow its elements from social life itself. But should the problem be formulated, and its solution sought for, "upside down", that is *ab absurdo*, then the overt content will become modified accordingly to form an inverted image of the social pattern actually present to the consciousness of the natives.' Claude Lévi-Strauss, 'Four Winnebago Myths: A Structural Sketch', in John

- Middleton (ed.) *Myth and Cosmos* (New York: Natural History Press, 1967) p. 20.
16. See Lévi-Strauss, *Structural Anthropology*, translated by Monique Layton (Chicago: University of Chicago Press, first published 1976) vol. 2, p. 193.
 17. 'There is no serious reason to isolate tales from myths; although a difference between the two is subjectively felt by a great many societies; although this difference is objectively expressed by means of special terms to distinguish the two genres; and finally, although prescriptions and prohibitions are sometimes linked with one and not the other (recitation of myths at certain hours, or during a season only, while tales, because of their "profane" nature, can be narrated any time) ..., it is observed that tales, which have the character of folktales in one society, are myths for another, and vice versa.' Lévi-Strauss, *Structural Anthropology*, pp. 127-8.
 18. See Lévi-Strauss, *Structural Anthropology*, pp. 153-4.
 19. Al-Jāhīz, *Kitāb al-Ḥayawān*, p. 72.
 20. The use of Roman architectural elements was quite widespread in Sasanian architecture. It can be seen, for instance, in the façade of Taq-i-Qusrau at Ctesiphon, as well as during the Parthian era, for instance in the city of Hatra whose princes were probably Arab. This supports the hypothesis that Sasanian rulers and their Arab vassals may have used Roman architects.
 21. Tabari, *Tārīkh*, vol. 1, p. 404.
 22. Lévi-Strauss asserts that to apprehend the meaning of a myth it is necessary to look for its functions. 'In order to define the functions, considered as the basic components of the tale, the *dramatis personae* will first be eliminated, their roles being "only" to support the functions. A function will be expressed simply by the name of an action: "interdiction", "flight" and so forth. Secondly, in defining a function, its place in the narrative must be taken into account. A wedding, for instance, can have different functions, depending on its role. Different meanings are given to identical acts, and vice versa; and this can only be determined by replacing the event among others, i.e., by situating it in relation to preceding and succeeding events. This presupposes that the succession of functions is constant. ... It is also taken for granted that each tale, taken individually, never shows the totality of the functions enumerated but only some of them without the order of succession being modified.' Lévi-Strauss, 'Reflections on a Work by Vladimir Propp', pp. 1118-19.
 23. See Roland Barthes, 'Introduction à l'Analyse structurale du Récits', in R. Barthes, W. Kayser, W. C. Booth and Ph. Hamon, *Poétique du Récit* (Paris: Seuil, 1977) pp. 7-57.
 24. Roland Barthes asserts that the analysis of denotation should be called communication, and that the term signification should be reserved for

- the analysis of connotation. For a brief and concise discussion of the two concepts, see Roland Barthes, *Elements of Semiology*.
25. See Lévi-Strauss, 'Reflections on a Work by Vladimir Propp'; and Lévi-Strauss, *Structural Anthropology*, vol. 2.
 26. Al-Asfahāni, *Kitāb al-Aghāni* (Beirut: Dar Iḥyā' al-Thurāt al-'Arabi, 1994) vols 1–2, p. 423.
 27. The legend of Sinimmār may also be interpreted as a paradigm of the relationship between power and knowledge, and of the power of the learned over the king. It would be interesting to trace the evolution of this paradigm in the literary genre of the *Adab al-Muluk*.
 28. Yaqubi, *Tārīkh al-Ya'qubi* (Beirut: Daar Saadir) vol 1, pp. 209–10. The Sadir is another famous palace. The word *sadir* means dazzling, marvellous.
 29. Tabari, *Tārīkh*, vol. 1, pp. 405–6.
 30. Al-Asfahāni, *Kitāb al-Aghāni*, vols 1–2, p. 418.
 31. Ibn al-Athīr (d. 630 AH) *Al-Kāmil* (Beirut: Dar al-Kitāb al-'Arabi, 1983) vol. 1, pp. 233–4.
 32. After his accession to the caliphate 'Umar Ibn 'Abd al-'Aziz became a devout *sufi* and, according to al-Jāhīz, planned to unadorn the Umayyad mosque at Damascus. See al-Jāhīz, *Kitāb al-Ḥayawān*, vol. 1, p.56. On this issue see next chapter.
 33. Edmund R. Leach, 'Genesis as Myth', in John Middleton (ed.) *Myth and Cosmos* (New York: The Natural History Press, 1967) p. 2.
 34. 'The property of folktales is to attribute identical actions to various personages. It is the constant elements which will be used as a base provided that it can be shown that the number of the functions is finite. Now, we see that they recur very often. Thus it can be said that the number of functions is startlingly small compared with the great number of *dramatis personae*. This explain the twofold quality of a folktale: it is amazingly multiform, picturesque, and colourful, and, to no less a degree: remarkably uniform and recurrent' (Lévi-Strauss, 'Reflections on a Work by Vladimir Propp', pp. 118–19).
 35. Al-Hamadhāni, *Al-Iklil (al-Juz' al-Thāmin)* edited by Nabih Amin Faris (Princeton: Princeton University Press, 1940) p. 183.
 36. Qur'an, S. LXXXIX, 6–8.
 37. Iram was also identified with Ubar or Wabar. The most recent attempt of identification and localization of Iram as Ubar is in the work of Nicholas Clapp, *The Road to Ubar: Finding the Atlantis of the Sands* (Boston: Houghton Mifflin Company, 1998). It is a lively and charming narrative full of adventure and suspense, even if the remains at Ubar are not in themselves of any great note.
 38. Ibn Khaldun, *The Muqaddimah*, abridged version, p. 17.
 39. *Ibid.*, p. 18.
 40. Al-Hamadhāni, *Al-Iklil*, p. 33.
 41. The same stories are reported by contemporary commentators, such as

Mohammed Hussin al-Shirazi, *Tafsir Taqrib al-Qur'an ilā al-Adhān* (Beirut: Mu'assasat al-Wafā, 1980) vol. 10, p. 133. He says: 'And it is said that Shaddād, a son of 'Ād, extended his kingdom and became very powerful. He was an unbeliever. He heard about Paradise and he said: "let's build a Paradise on earth." And he built it in Iram and gave it this name ... and they were all destroyed.'

42. On Ka'b al-Aḥbar, see Moshe Perlmann, 'A Legendary Story of Ka'b al-Aḥbar's Conversion to Islam', *The Joshua Starr Memorial Volume*, Jewish Social Studies, no. 5, New York, 1953, pp. 85–9; and 'Another Ka'b al-Aḥbar Story', *Jewish Quarterly Review*, vol. 45, no 1, 1954, pp. 48–51.
43. Khoury, 'The Dome of the Rock', p. 61, writes: 'The Marwanids are reputed to have possessed a book on the histories of ancient kings.'
44. See al-Mas'udi, *Murūj Addahab wa Ma'adin al-Jawhar*, edited by Yusuf As'ad Dagher (Beirut: Dar al-Andalus, n.d.) vol. 2, p. 430.
45. Qur'an, S. VII, 74.
46. Qur'an, S. XXVI, 128–9.
47. Quoted in Pandolfo, *Impasse of the Angels*, p. 57.
48. Al-Hamadhāni, 'The Tomb of Dhu al-Qarnain', in *Al-Iklil*, p. 198.
49. Al-Asfahāni, *Kitāb al-Aghāni*, vol.4, p. 307.
50. Qur'an, S. xxvi, 129.

5. Al-Jāhīz in the Mosque at Damascus: Social Critique and Debate in the History of Umayyad Architecture

1. Al-Jāhīz, *Kitāb al-Ḥayawān*, vol. 1, pp. 56–7.
2. Grabar, *The Formation of Islamic Art*, p. 210.
3. *Ibid.*, p. 208.
4. Grabar, *Formation of Islamic Art*, p. 209 claims that 'the written sources do not indicate the existence of a doctrine on the arts before the tenth century.' In his latest book, he maintains the same assertion (Grabar, *Penser l'Art Islamique Aujourd'hui*, p. 51).
5. See Panofsky, *La Renaissance et ses Avants-Courriers dans l'Art d'Occident*.
6. Grabar, *Formation of Islamic Art*, pp. 43–71; Nasser Rabbat, 'The Meaning of the Umayyad Dome of the Rock', *Muqarnas*, vol. 6, 1989, pp. 11–21. In an interesting article, Nuha Khoury suggests that the Dome of the Rock 'projected images of ancient dynastic shrines such as Maharib Ghumdan and Mahrib Suleyman and stood as an emphatic point of transfer from the old Islamic caliphate to a new Umayyad dynastic regime' (Khoury, 'The Dome of the Rock', p. 62).
7. Richard Ettinghausen and Oleg Grabar, *The Art and Architecture of Islam, 650–1250* (New York: Penguin Books, 1991) p. 44.
8. See Grabar, *Formation of Islamic Art*, pp. 44–6.
9. Yaqubi, *Tārīkh al-Ya'qubi*, vol. 2, p. 306.
10. Muqaddasi, *Kitāb Aḥsan al-Taqāsīm*, p. 159.
11. Grabar. *Formation of Islamic Art*, pp. 61–2.

12. Al-Jāhīz, *Al-Bayān wa al-Tabayīn*, p. 501. Also reported by Tabari, *Tārīkh*, vol. 4, p. 256.
13. Muqaddasi, *Kitāb Aḥsan al-Taḳāsīm*, p. 156.
14. *Ibid.*, p. 160.
15. See J. M. Cowan, *Arabic-English Dictionary* (New York: Spoken Language Services, 1976) pp. 991–2.
16. Ibn Manẓūr, *Lisan al-'Arab*, vol. 7, p. 100.
17. See for instance Jean Sauvaget, 'Esquisse d'une Histoire de la Ville de Damas'.
18. Muqaddasi, *Kitāb Aḥsan al-Taḳāsīm*, p. 160.
19. Al-Tha'ālibi, *'Adāb al Mulūk* (Beirut: Dar al-Gharb al-Islāmi, 1990) p. 113, translated by K. A. C. Creswell in the epigraph to *Muslim Architecture of Egypt* (Oxford: Clarendon Press, 1952).
20. In discussing this point, al-Jāhīz (*Kitāb al-Ḥayawān*, vol. 1, p. 73) seeks to demonstrate the superiority of writing, a pre-Islamic Arab custom, over building, a custom borrowed from the Sasanians.
21. Qasr al-Ḥajjaj later lent its name to its neighbourhood. See Jean Sauvaget, 'Esquisse d'une Histoire de la Ville de Damas', p. 457.
22. Furthermore, the spatial organization of the mosque, as Jean Sauvaget has already pointed out, with its *maqṣura* and axial nave, was related to the Umayyad royal ceremonies, which at the time must have been evident to the people. See Jean Sauvaget, *La Mosquée omeyyade de Médine*.
23. Nasser Rabbat, 'The Dome of the Rock Revisited: Some Remarks on al-Wasiti's Accounts', *Muqarnas*, vol. 10, p. 73, writes: 'The Dome's political meaning was superseded by its underlying religious relevance after the re-establishment of firm Umayyad control over the entire Islamic empire in the second part of 'Abd al-Malik's reign.'
24. Ibn Khaldun, *Discours sur l'Histoire universelle: Al-Muqaddima*, translated into French by Vincent Monteil (Paris: Sindbad, 1978) p. 346. Monteil translates *bulat* into French as *chaussée*, which in that context, does not make sense. Another meaningful translation of *bulat* is aisle.
25. For a complete survey of the literary sources on al-Madīna's mosque, see Jean Sauvaget, 'Esquisse d'une Histoire de la Ville de Damas'.
26. Yaqubi, *Tārīkh al-Ya'qubi*, vol. 2, p. 284.
27. *Ibid.*, vol. 3, p. 676.
28. *Ibid.*, vol. 3, p. 677.
29. Marguerite Gautier-van Berchem, 'The Mosaics of the Dome of the Rock in Jerusalem and the Great Mosque in Damascus', in K. A. C. Creswell, *Early Muslim Architecture* (Oxford: Clarendon Press) vol. 1, Part 1, 1969, p. 244. The author also shows that the earliest account, namely that of Baladhuri, speaks explicitly of Greeks and Copts, inhabitants of Syria and Egypt, and says that Yaqubi, a less reliable source, was the first to speak of the Byzantine emperor's help.
30. A later story by Samhūdi (1316 AH) reported by Creswell identifies the

- style of the Umayyad mosque at al-Madīna with the style of Christian churches, but that story is too distant from the time of the construction of the Umayyad mosque to supply meaningful information. Creswell, *Early Muslim Architecture*, vol. 1, part 1, p. 147.
31. The expression is that of Marshall G. S. Hodgson, *The Venture of Islam: Conscience and History in a World Civilization* (Chicago: University of Chicago Press, 1974) vol. 1, p. 207.
 32. Tabari, *Tārīkh*, vol. 2, p. 492.
 33. 'In that year 'Uthman built his house, and Azzaoura'. He also extended the masjid of the prophet in 29. The stones were brought from *Batn Nakhl*. He put lead in the pillars. The masjid became thus one hundred and sixty cubits long, and one hundred and fifty cubits wide. There remained six doors as in 'Umar's time' (Yaqubi, *Tārīkh*, vol. 2, p. 166).
 34. Tabari, *Tārīkh*, vol. 2, p. 595.
 35. 'Umar Ibn 'Abd al-'Aziz is also called 'Umar II which relates him to 'Umar Ibn al-Khattab or 'Umar I.
 36. Tabari, *Tārīkh*, vol. 4, p. 61; and Yaqubi, *Tārīkh*, vol. 2, p. 301.
 37. Tabari, *Tārīkh*, vol. 4, p. 62.
 38. *Ibid.*, vol. 4, p. 64.
 39. After receiving his first courier from 'Umar, one governor is supposed to have said: 'I am not one of his governors. His discourse is not like that of his predecessors.' Tabari, *Tārīkh*, vol. 4, p. 69.
 40. Al-Jāhīz, *Kitāb al-Ḥayawān*, vol. 3, p. 15.
 41. Interestingly, Wellhausen says about him: 'He did not punish political crimes, though [he was] severe against others.' J. Wellhausen, *The Arab Kingdom and its Fall*, translated by Margaret Graham Weir (Calcutta: University of Calcutta Press) p. 309.
 42. He also exempted the Persians from the new year's gifts, a custom his predecessors had imposed, as non Islamic, and redecreed the right of women to inheritance. To avoid being buried at the expense of the public treasury, he bought in anticipation and by his own means a burial place. Tabari, *Tārīkh*, vol. 4, p. 72.
 43. In *Kitāb al-Thaj Fī Akhlāqī al-Mulūk*, edited by Fawzy Attawi (Beirut: Al-Sharika al-Lubnania li al-Kitāb, 1970) a book attributed to al-Jāhīz, it is reported (p. 39): 'I asked (Iṣḥak Ibn Ibrahim): and what of 'Umar Ibn 'Abd al-'Aziz? He answered: he never heard any song from the time he was made caliph until he died. But before that, when he was prince of al-Madina, he used to listen to songs and music, yet he showed only correct behaviour. Some times he applauded, and he even would sway to and fro in his divan, or kick the ground with his feet, and enjoy the music. But he never trespassed the limits of noble enjoyment.'
 44. For a brief summary of his policy, see Hodgson, *The Venture of Islam*, vol. 1, pp. 269–70. Von Grunebaum (*Classical Islam*, p. 74) sums up that policy as follows: 'Attempts to reconcile the tax on the subject population with

the precepts of Islam were undertaken more than once towards the end of the Umayyad period. The model was provided by the pious caliph 'Umar (II) ibn 'Abd al-'Aziz (717–720): converts would be freed of poll tax but must pay land tax, although they had forfeited their possession of the land by their conversion; the new Muslim was to continue on the land as a tenant. This system did not go into operation right away – the caliph died after ruling less than three years – but it laid down the principles which were gradually to become standard.'

45. On 'Umar II and the invention of the *miḥrab*, see Creswell, *Early Muslim Architecture*, vol. 1, part 1, p. 147; and Jean Sauvaget, *La Mosquée omeyyade de Médine*. Sauvaget also shows that 'Umar paid particular attention to the spatial organization of that mosque and discussed it in detail with the 'ulama of al-Madina (pp. 118–19). In an interesting article, 'The Origins of the Miḥrab Mujawwaf', Estelle Whelan challenged Sauvaget's thesis about the function of the *miḥrab*, and his linking of the mosque with the basilical audience hall of antiquity. In fact such a critique was implicit in Grabar's *Formation of Islamic Art*, precisely by his rejection of the basilica as a model for the origin of the mosque.
46. He is reported by Ibn Sa'd (d. CE 845) to have said: 'Oh, Umm Salama! Verily the most unprofitable thing that eateth up the wealth of a believer is building.' Quoted by Hoag, *Islamic Architecture*, p. 10.
47. Al-Mas'udi, *Murūj Addahab*, vol. 2, p. 430.
48. *Ibid.*, vol. 2, p. 386.
49. Grabar, *Formation of Islamic Art*, pp. 206–7.
50. Saint Bernard, *Apologie à Guillaume*, quoted in Georges Duby, *Saint Bernard: L'Art cistercien*, p. 134.
51. Allen, *Five Essays on Islamic Art*, pp. 2 and 15 respectively.
52. Qur'an, S. 128–9.
53. Qur'an, S. 130.
54. Al-Jāhiz, *Al-Ma ḥāsin wa-l-addād*, p. 58.

6. Architecture and Desire

1. Ernst Bloch, *The Utopian Function of Art and Literature: Selected Essays*, translated by Jack Zipes and Frank Mecklenburg (Cambridge, MA: MIT Press, 1989) p. 85.
2. *Ibid.*, p. 278.
3. Tabari, *Tārīkh*, vol. 2, p. 480.
4. Jean-Pierre Protzen, 'Reflections on the Fable of the Caliph, the Ten Architects and the Philosopher', *Journal of Architectural Education*, vol. 34, no. 4, 1981, pp. 2–8, argues that idoneity, defined as 'that which is proper to, and conforms with, the ends and intentions', should be the guiding principle of architectural design and the basis for the relationship of the architect and his clients. His approach is clearly related to the debates of the 1960s and 1970s about the possibility of a democratic practice of

architecture, and the principle of idoneity he advocates may be submitted to the same critiques the author himself makes to democratic processes in connection with the expression of truth. Indeed, expressed ends and intentions may be demagogic or illusory, for they too are part of the democratic process, which cannot, according to Protzen, deliver the truth. The truth lies in the conflicting desires of the architect and his clients.

5. Grabar, *Formation of Islamic Art*, p. 209.
6. Roland Barthes, *Elements of Semiology*, p. 31.
7. In her discussion of the use of drawings in the history of Islamic building tradition, G. Necipoğlu also notes that rulers are reported to have drawn plans of their palaces. 'For example', she writes, 'the Persian historian Bayhaqi (995–1077) recorded that the Ghaznavid ruler Mas'ud I (r. 1031–41) himself drew the plans for buildings on paper: he built with his own knowledge of geometry, and drew the lines with his own exalted hand and that among these same facilities his geometry was particularly marvelous' (Necipoğlu, *The Topkapi Scroll*, p. 4).
8. This does not mean that painters and poets are completely free from the interventionism of patrons. It is known, for example, that in Medieval Europe the Church used to practise strict supervision over painters, and that clergymen and patrons often obliged even Renaissance painters to revise their works and make them conform to the Church views.
9. Mayer, *Islamic Architects*, p. 19.
10. *Ibid.*, pp. 18 and 45.
11. *Ibid.*, p. 12.
12. Al-Khalil, *Kitāb al-'Ayn*, vol. 4, p. 120.
13. Muhammad Ibn Ahmad al-Azhari, *Tahdhib al-Lughah* (Cairo: The Egyptian Company for Authorship and Translation, 1966) vol. 4, p. 520.
14. Muqaddasi, *Kitāb Aḥsan al-Taqāsīm*, p. 121. In the context of building a new city the recourse to the *muhandis* is natural, for the problem of providing the city with running water is central to the enterprise.
15. The report is followed by a description of the techniques of construction used by Muqaddasi's grandfather. *Ibid.*, p. 163.
16. Renata Holod, 'Text, Plan and Building: On the Transmission of Architectural Knowledge', in Margaret Bentley Sevckenko (ed.) *Theories and Principles of Design in the Architecture of Islamic Societies* (Cambridge, MA: The Aga Khan Program for Islamic Architecture, 1988) pp. 1–12.
17. Jonathan M. Bloom, 'On the Transmission of Designs in Early Islamic Architecture', *Muqarnas*, vol. 10, 1993, pp. 21–8.
18. Holod, 'Text, Plan and Building', p. 11.
19. Bloom, 'On the Transmission of Designs', p. 21.
20. *Ibid.*, p. 26.
21. Spiro Kostof (ed.) *The Architect: Chapters in the History of the Profession* (Berkeley: University of California Press, 2000) p. 65.
22. On the Qur'an frontispieces, see Hans-Gaspar Graf von Bothmer,

- 'Masterworks of Islamic Book Art: Koranic Calligraphy and Illumination in the Manuscripts found in the Great Mosque in Sanaa', in Werner Daum (ed.) *Yemen: 3000 Years of Art and Civilization in Arabia Felix*, (Innsbruck: Pinguin-Verlag, 1988) pp. 178–81.
23. On this issue see the interesting discussion of the two frontispieces in Grabar, *The Mediation of Ornament*, Chapter 4, pp. 155–93.
 24. Margaret Gautier-van Berchem, 'Le Palais de Sedrata dans le Désert saharien', in *Studies in Islamic Art and Architecture in Honor of Professor K. A. C. Creswell* (Cairo: The American University Press in Cairo, 1965) pp. 8–29.
 25. See Mayer, *Islamic Architects*, p. 28.
 26. Valéry, 'Mémoires d'un Poète', p. 1452.
 27. Jamel Akbar, 'Khaṭṭa and the Territorial Structure of Early Muslim Towns', *Muqarnas*, vol. 6, 1989, pp. 22–32.
 28. *Ibid.*, p. 25. Of course there are other interpretations of the term. For instance, Nezar al-Sayyad asserts that 'the *khutat* of Kufah was mainly a schematic plan marked out on the land, designating a geometrical planning grid' (al-Sayyad, *Cities and Caliphs*, p. 65). I naturally tend to agree with that view.
 29. Al-Kahlil, *Kitāb al-'Ayn*, edited by Mahdi Makhzoumi and Ibrahim as-Samarra'i, vol. 4, pp. 136–7.
 30. Muhammad ibn al-Hasan Ibn Durayd, *Kitāb Jamharat al-Lughah* (Baghdad: Al-Muthanna Library, 1970) vol. 1, p. 67.
 31. Al-Azhari, *Tahdhib al-Lughah*, entry *Khaṭṭa*, vol. 4, p. 557.
 32. Al-Kahlil, *Kitāb al-'Ayn*, edited by Mahdi Makhzoumi and Ibrahim as-Samarra'i, vol. 7, p. 210.
 33. Sigmund Freud, *Leonardo da Vinci and a Memory of His Childhood*, in Sigmund Freud, *Selected Writings*, introduced by Robert Coles (New York: Book of the Month Club, 1997).
 34. It would be fair to emphasize that Freud was unjustly attacked for giving too much attention to the outline of a vulture visible in Leonardo's Saint Anne, at the Louvre, Paris, for in his essay he seems to be more concerned with the smile of Mona Lisa, which is also depicted in Saint Anne. Moreover, the discovery of the outline of the vulture in Saint Anne was made by another author after the publication of Freud's essay in 1910. In a note added in 1919 Freud writes: 'A remarkable discovery has been made in the Louvre picture by Oskar Pfister, which is of undeniable interest, even if one may not feel inclined to accept it without reserve. In Mary's curiously arranged and rather confusing drapery he has discovered the outline of a vulture and he interprets it as an unconscious picture-puzzle' (Freud, *Leonardo da Vinci*, p. 206).
 35. As Roland Barthes says in *The Pleasure of the Text*, translated by Richard Miller (New York: Hill & Wang, 1975) p. 56: 'one can feel desire for a character in a novel (in fleeting impulses).'
 36. It should be noticed that the Arabic text says *tadullu 'alaynā*, which

- clearly indicates that monuments are perceived as a proof, and evidence as opposed to the view of monuments as traces of the past.
37. This verse was inspired by al-Aḥnaf who says: 'the best rooms are those where the gaze can travel' (Ibn al-Jahm Ali, *Diwan*, edited by Khalil Marum (Damascus: Al-Majma' al-'ilmi al-'Arabi, 1949) p. 29, note 1).
 38. I am well aware that the word *ladhdhah* could be translated into pleasure, delight, or lust, but what follows in the account, *ka ladhdhati al-nisā' i wa l-khamri, wa ba'duhu yad'ū ba'dan*, indicates that the word desire is a more suitable translation.
 39. Al-Tha'ālibi, *'Adāb al Mulūk*, pp. 113–15.
 40. Al-Asfahani, *Kitāb al-Aghāni*, vols 9–10, pp. 383–406.
 41. And Tabari (*Tārīkh*, vol. 5, p. 327) reports that al-Mutawakkil was offered the 'anaza of the prophet.
 42. Al-Mas'udi, *Murūj Addahab wa Ma'adin al-Jawhar*, vol.4, pp. 4–5.
 43. Tabari, *Tārīkh*, vol. 5, p. 327.
 44. *Ibid.*, vol. 5, pp. 304 and 318.
 45. *Ibid.*, vol. 5, p. 312.
 46. *Ibid.*, vol. 5, p. 330.
 47. Al-Mas'udi, *Murūj Addahab wa Ma'adin al-Jawhar*, vol 4, p. 40.
 48. Malraux, *Les Voix du Silence*, pp. 417–18.
 49. Freud, *Leonardo da Vinci*, p. 225.
 50. *Ibid.*, p. 209.
 51. *Ibid.*, pp. 204–5.
 52. See Sigmund Freud, *The Interpretation of Dreams*, translated by James Strachey (New York: Discus Books/Avon, 1971) in particular Chapter 6, 'The Dream-Work', pp. 311–546. Jean François Lyotard, *Discours, Figure* (Paris: Editions Kliensick, 1971) later developed the same comparison between painting and dream to argue the specificity and autonomy of painting and of the visual from spoken language, as opposed to the primacy of the signifier in the Lacanian theory of the subject. Aside from this argument, it is interesting to note that this author was able to show how the mechanisms of construction of dreams (condensation, displacement) were equally found in painting. His formula 'the dream-work does not think' summarizes his view that visual language functions according to its own mechanisms, and cannot be reduced to expressing thought, or conveying concepts.
 53. See Jacques Lacan, *Le Séminaire, Livre XI, Les Quatres Concepts fondamentaux de la Psychanalyse* (Paris: Editions du Seuil) pp. 79–80.
 54. Lacan, *Le Séminaire, Livre XI*, p. 102.
 55. It is both true and very naïve to believe, as Clare Cooper Marcus, *House as a Mirror of Self: Exploring the Deeper Meaning of Home* (Berkeley: Conari Press, 1995) p. 17, says: 'Unable to comprehend all that is encapsulated in the psyche, we need to place it "out there" [in our house] for us to contemplate, just as we need to view our physical body in a mirror.'

The phenomenon is not simply a narcissistic mechanism limited to the self-gratification of the ego; it fundamentally implies the other. What we place 'out there' is not for us to contemplate but is addressed to the other, for, as Jacques Lacan, 'The Function and Field of Speech and Language in Psychoanalysis', in Jacques Lacan, *Ecrits: A Selection*, translated by Alan Sheridan (New York: W. W. Norton & Company, 1977) p. 58 says: 'man's desire finds its meaning in the desire of the other, not so much because the other holds the key to the object desired, as because the first object of desire is to be recognized by the other' but this recognition is symbolic, and beyond the imaginary illusion. This is more easily visible in the function of display of architecture, in particular, in palatial architecture, which Clare Cooper Marcus chose not to consider in her work. The fact that she limited her observation to a middle-class group of volunteers is clearly a bias that guarantees to her approach, which is based on the theory of the ego, the finding her views presuppose. We should also recall that the ego is not the subject. See Jacques Lacan, *Le Séminaire, Livre II, Le Moi dans la Théorie de Freud et dans la Technique de la Psychanalyse* (Paris: Editions du Seuil, 1978) p. 197. The ego is not the subject and it is by essence alienation.

56. Lacan, 'The Function and Field of Speech', p. 86.
57. *Ibid.*, p. 48.
58. On these issues see Philippe Boudon, *Pessac Corbusier* (Paris: Editions Bordas, 1993); and Jencks, *The Language of Postmodern Architecture*.
59. On the relation of representation and construction in Gothic architecture, see Jean Gimpel, *The Cathedral Builders*, translated by Teresa Waugh (New York: Harper Perennial, 1992).
60. John James, *The Contractors of Chartres* (London: Mandorla Publications, 1978).
61. This verse was inspired by al-Aḥnaf who says: 'Aṭyabu al-majālis allatī fihā yusāfiru al-naẓaru, the best rooms are those where the gaze can travel.' Ibn al-Jahm Ali, *Diwan*, p. 29, note 1.
62. Ibn al-Jahm Ali, *Diwan*, pp. 28–30.
63. Grabar, *The Formation of Islamic Art*, pp. 43–71.
64. Creswell, *A Short Account*, p. 366.
65. See Ibn al-Mu'taz, *Diwan*, edited by Karam al-Bustani (Beirut: Dar Sader, n.d.) pp. 215, and 395–6.
66. It is worth noting that the mythical connection of music and grandiose buildings found in al-Hamadhāni's *Al-Iklil* can be found in earlier works about historical buildings.
67. I would like to express my gratitude to Baber Johansen, from the Ecole des Hautes Etudes, Paris, who first brought my attention to the work of al-Shāfi'ī.
68. There is, however, a controversy about al-Shāfi'ī being the true author

- of the *Al-Kitāb al-Umm* as it is possible that the book was written posthumously on the basis of his teaching in the early tenth century.
69. Al-Shāfi'ī, *Al-Kitāb al-Umm* (Beirut: Dar Qutayba) vol. 2, p. 85.
 70. *Ibid.*, p. 93.
 71. *Ibid.*, p. 239.
 72. *Ibid.*, p. 301.
 73. *Ibid.*, p. 182.
 74. Qur'an, S. vi: 97.
 75. Qur'an, S. ii: 15.
 76. Al-Shāfi'ī, *Al-Kitāb al-Umm*, p. 107.
 77. *Ibid.*, pp. 284–5.
 78. The text was edited and translated by Max Meyerhof, and published in 1928 in Cairo by the Government Press.
 79. Ibn Ishāq, *The Book of the Ten Treatises*, pp. 35–6.
 80. *Ibid.*, p. 37.
 81. *Ibid.*, p. 37.
 82. *Ibid.*, p. 109.
 83. *Ibid.*, p. 37.
 84. *Ibid.*, pp. 37–8. We read in *The Notebooks of Leonardo da Vinci*, translated and edited by Edward MacCurdy (New York: George Braziller, 1955): 'The medium that is between the eye and the object seen transforms this object to its own color. So the blueness of the atmosphere causes the distant mountain to seem blue' (p. 241). 'The surface of every opaque body shares in the color of surrounding objects' (p. 260).
 85. Michel Foucault, *The Order of Things: An Archaeology of the Human Sciences* (New York: Vintage Books, 1973) p. xvii.
 86. The same reproach was made against the Umayyad caliph al-Walīd. Yaqubi (*Tārīkh al-Ya'qubi*, vol. 2, p. 333) writes: 'al-Walīd was neglecting his function, careless of his entourage, and he was keen of divertissement and singing, and exhibition of injustice and assassination, and disregard for public affairs, and drinking and buffoonery, and he exceeded in his impudence when he wanted to build on the top of the *ka'ba* a room for entertainment.'
 87. Al-Hamadhāni, *Al-Iklil*, p. 209.

7. Conclusion

1. Ludwig Wittgenstein, *Culture and Value*, translated by Peter Winch (Chicago: University of Chicago Press, 1984) p. 8e.
2. On this issue see Gaston Bachelard, *La Formation de l'Esprit scientifique: Contribution à une Psychanalyse de la Connaissance objective* (Paris: Librairie Philosophique Jean Vrin, 1957); and Gaston Bachelard, *The New Scientific Spirit*, translated by Arthur Goldhammer (Boston: Beacon Press, 1984).
3. This is a traditional issue concerning the relationship of linguistics and semiology. As Roland Barthes (*Elements of Semiology*, p. 10) writes: 'it

NOTES

appears increasingly more difficult to conceive a system of images and objects whose signifieds can exist independently of language: to perceive what a substance signifies is inevitably to fall back on the individuation of a language: there is no meaning which is not designated, and the world of signifieds is none other than that of language.'

4. Grabar, *The Mediation of Ornament*, p. 45.
5. When discussing mystic movements of thirteenth-century Europe, Michel de Certeau writes: 'ever since theology became a professional endeavour, spiritualists and mystics have taken up the challenge of truthful speech (*la parole*). They have thus been deported to the side of the fable!' (Michel de Certeau, *La Fable mystique* (Paris: Editions Gallimard, 1982) p. 24, my translation).

References

- Abu-Lughod, L. Janet (1987) 'The Islamic City: Historic Myth, Islamic Essence, and Contemporary Relevance', *International Journal of Middle East Studies*, vol. 19, pp. 155–76
- Adonis (1990) *An Introduction to Arab Poetics*, translated by Catherine Cobham (Austin: University of Texas Press)
- Adorno, Theodor (1973) *Philosophy of Modern Music*, translated by Anne G. Mitchell and Wesley V. Blomster (New York: The Seabury Press)
- Adorno, Theodor (1997) *Prisms*, translated by Samuel and Shierry Weber (Cambridge, MA: MIT Press, first published 1967)
- Aga Khan Award for Architecture (1978) *Toward an Architecture in the Spirit of Islam*, Proceedings of Seminar no 1, Gouvieux, France.
- Aga Khan Award for Architecture (1978) *Conservation as Cultural Survival*, Proceedings of Seminar no 2, Istanbul, Turkey.
- Aga Khan Award for Architecture (1979) *Architecture as Symbol and Self-Identity*, Proceedings of Seminar no. 4, Fes, Morocco.
- Akbar, Jamel (1989) 'Khaṭṭa and the Territorial Structure of Early Muslim Towns', *Muqarnas*, vol. 6, pp. 22–32
- Allen, Terry (1988) *Five Essays on Islamic Art* (Sebastopol, CA: Sollipsist Press)
- Amin, Ahmad (1974) *Ḍuḥa al-Islam* (3 vols, Cairo: Maktabat an-Nahda al-Masria, first published 1933)
- Ardalan, Nader and Laleh Bakhtiar (1973) *The Sense of Unity: The Sufi Tradition in Persian Architecture* (Chicago: University of Chicago Press)
- Arnheim, Rudolf (1978) *Towards a Psychology of Art* (Berkeley: University of California Press)
- al-Asfahani (d. 356 AH) (1994) *Kitāb al-Aghani*, 24 vols in 13 parts (Beirut: Dar Iḥyā' Athurāt al-'Arabi)
- al-Aṣma'ī, 'Abd al-Malik ibn Qurayb (CE 740–c.828) (1953) *Fuḥūlat al-Shu'arā*, edited by Mohammed 'Abd al-Mun'im Khafaji and Taha Mohammed al-Zini (Cairo: al-Natba'ah al-muniriyah bi al-Azhar)

- al-Azhari, Muhammad Ibn Ahmad (282–370 AH/CE tenth century) (1966) *Tahdhib al-Lughah* (15 vols, Cairo: The Egyptian Company for Authorship and Translation)
- Bachelard, Gaston (1957) *La Formation de l'Esprit scientifique: Contribution à une Psychanalyse de la Connaissance objective* (Paris: Librairie Philosophique Jean Vrin)
- Bachelard, Gaston (1969) *The Poetics of Space*, translated by Maria Jolas (Boston: Beacon Press, first published 1958)
- Bachelard, Gaston (1984) *The New Scientific Spirit*, translated by Arthur Goldhammer (Boston: Beacon Press)
- Badiwi, Anas, Hamdu Tammam and Hassan Attibi (2005) *Rawai' al-Shi'r al-Umawi* (Beirut: Dar El-Marefah)
- Baer, Eva (1998) *Islamic Ornament* (New York: New York University Press)
- Barthes, Roland (1975) *The Pleasure of the Text*, translated by Richard Miller (New York: Hill & Wang, first published 1973)
- Barthes, Roland (1977) 'Introduction à l'Analyse structurale du Récits', in R. Barthes, W. Kayser, W. C. Booth and Ph. Hamon, *Poétique du Récit* (Paris: Seuil)
- Barthes, Roland (1994) *Elements of Semiology*, translated by A. Lavers and C. Smith (New York: Hill & Wang, first published 1964)
- Barzun, Jacques (1973) *The Use and Abuse of Art* (Washington, DC: National Gallery of Art)
- Bataille, Georges (1991) *The Accursed Share*, translated by Robert Hurley (New York: Zone Books, first published 1967)
- Bateson, Mary Catherine (1970) *Structural Continuity in Poetry: A Linguistic Study of Five Pre-Islamic Arabic Odes* (Paris: Mouton & Co.)
- Bencheikh, Jamal Eddine (1998) *Poétique arabe: Essai sur un Discours critique* (Paris: Stock)
- Benslama, Fethi (1988) *La Nuit brisée* (Paris: Ramsay)
- Bloch, Ernst (1989) *The Utopian Function of Art and Literature: Selected Essays*, translated by Jack Zipes and Frank Mecklenburg (Cambridge, MA: MIT Press)
- Bloom, Jonathan M. (1993) 'On the Transmission of Designs in Early Islamic Architecture', *Muqarnas*, vol. 10, pp. 21–8
- Boudon, Philippe (1993) *Pessac Corbusier* (Paris: Editions Bordas)
- Bourdieu, Pierre (1975) 'Postface' to Erwin Panofsky, *Architecture gothique et Pensée scolastique* (Paris: Editions de Minuit)

REFERENCES

- Burckhardt, Titus (1976) *Art of Islam: Language and Meaning*, translated from French by Peter Hobson (London: Islamic Festival trust Ltd)
- Clapp, Nicholas (1998) *The Road to Ubar: Finding the Atlantis of the Sands* (Boston: Houghton Mifflin Company)
- Cooper Marcus, Clare (1995) *House as a Mirror of Self: Exploring the Deeper Meaning of Home* (Berkeley: Conari Press)
- Corbin, Henri (1964) *Histoire de la Philosophie islamique* (Paris: Editions Gallimard)
- Cowan, J. M. (1976) *Arabic-English Dictionary* (New York: Spoken Language Services, Inc)
- Creswell, K. A. C. (1952) *Muslim Architecture of Egypt* (2 vols, Oxford: Clarendon Press)
- Creswell, K. A. C. (1958) *A Short Account of Early Muslim Architecture* (New York: Penguin Books)
- Creswell, K. A. C. (1969) *Early Muslim Architecture* (Oxford: Clarendon Press) 2 vols, vol. 1 in 2 parts
- Darwish, 'Abd Allah (1967) 'Introduction', in Ibn Ahmad al-Khalil, *Kitāb al-'Ayn*, edited by 'Abd Allah Darwish (Baghdad: Dā'irat al-Shu'ūn al-Thaqāfiya wa al-Nashr)
- de Certeau, Michel (1982) *La Fable mystique* (Paris: Editions Gallimard)
- Doe, Brian (1983) *Monuments of South Arabia* (New York: Falcon-Oleander)
- Duby, Georges (1979) *Saint Bernard: L'Art cistercien* (Paris: Editions Flammarion)
- Eco, Umberto (1986) *Art and Beauty in the Middle Ages*, translated by Hugh Bredin (New Haven: Yale University Press)
- Ecohard, Michel (1978) *Filiation des Monuments grecs, byzantins et islamiques: une Question de Géométrie* (Paris: Librairie orientaliste Paul Geuthner)
- Ettinghausen, Richard (1977) *Arab Painting* (New York: Skira-Rizzoli, first published 1962)
- Ettinghausen, Richard and Oleg Grabar (1991) *The Art and Architecture of Islam, 650-1250* (New York: Penguin Books)
- Flood, Finbarr Barry (2001) *The Great Mosque of Damascus: Studies on the Makings of an Umayyad Visual Culture* (Leiden: Brill)

- Flood, Finbarr Barry (2002) 'Between Cult and Culture: Bamiyan, Islamic Iconoclasm, and the Museum', *Art Bulletin*, vol. 84, no. 4, December, pp. 641–59
- Foucault, Michel (1973) *The Order of Things: An Archaeology of the Human Sciences* (New York: Vintage Books)
- Foucault, Michel (1979) *Discipline and Punish: The Birth of the Prison*, translated by Alan Sheridan (New York: Vintage Books, first published 1975)
- Foucault, Michel (1982) *Ceci n'est pas une Pipe* (Paris: Editions Gallimard)
- Foucault, Michel (1990) *The History of Sexuality: An Introduction*, vol. 1, translated by Robert Hurley (New York: Vintage Books, first published 1978)
- Fowden, Garth (2003) *Qusayr 'Amra: Art and the Umayyad Elite in Late Antique Syria* (Berkeley: University of California Press)
- Freud, Sigmund (1971) *The Interpretation of Dreams*, translated by James Strachey (New York: Discus Books/Avon, first published 1900)
- Freud, Sigmund (1997) *Leonardo da Vinci and a Memory of His Childhood*, translated by James Strachey, in Sigmund Freud, *Selected Writings*, with an introduction by Robert Coles (New York: Book of the Month Club, first published 1910)
- Garaudy, R. (1985) *The Mosque, Mirror of Islam* (Paris: no publisher)
- Gautier-van Berchem, Margaret (1965) 'Le Palais de Sedrata dans le Désert saharien', in *Studies in Islamic Art and Architecture in Honor of Professor K. A. C. Creswell* (Cairo: The American University Press in Cairo, 1965) pp. 8–29
- Gautier-van Berchem, Marguerite (1969) 'The Mosaics of the Dome of the Rock in Jerusalem and the Great Mosque in Damascus', in K. A. C. Creswell, *Early Muslim Architecture* (Oxford: Clarendon Press) vol. 1, Part 1
- Gimpel, Jean (1992) *The Cathedral Builders*, translated by Teresa Waugh (New York: Harper Perennial, first published 1961)
- Goldziher, Ignaz (1981) *Introduction to Islamic Theology and Law*, translated by Andras and Ruth Hamori (Princeton: Princeton University Press, first published 1910)
- Gombrich, E. H. (1978) *The Story of Art* (New York: Phaidon Press)
- Gonzalez, Valerie (2001) *Beauty and Islam: Aesthetics in Islamic Art and Architecture* (London: I.B.Tauris)

REFERENCES

- Grabar, Oleg (1985) 'Upon Reading al-Azraqi', *Muqarnas*, vol. 3, pp. 1-7)
- Grabar, Oleg (1987) *The Formation of Islamic Art* (New Haven: Yale University Press, first published 1973)
- Grabar, Oleg (1992) *The Mediation of Ornament* (Princeton: Princeton University Press)
- Grabar, Oleg (1996) *Penser l'Art Islamique Aujourd'hui* (Paris: Albin Michel)
- Grabar, Oleg (2004) 'The Mosque', in Markus Hattstein and Peter Delius (eds), *Islam, Art and Architecture* (Königswinter: Könemann, 2004)
- Halévy, Jean (1907) 'Khawarnak et Sinimmar', *Revue Sémitique* (Paris, edited by Ernest Leroux) vol. 15, pp. 101-7
- al-Hamadhāni, *Al-Iklil (al-Juz' al-Thāmin)* (1940) edited by Nabih Amin Faris (Princeton: Princeton University Press)
- Hamilton, R. W. (1959) *Khirbat Al Mafjar: An Arabian Mansion in the Jordan Valley*, with a contribution by Oleg Grabar (Oxford: Clarendon Press)
- Herzfeld, Ernst (1923) *Die Ausgrabungen von Samarra/Erster Band, Der Wandschmuck der Bauten von Samarra und seine Ornamentik* (Berlin: Dietrich Reimer)
- Herzfeld, Ernst (1927) *Die Malereien von Samarra* (Berlin: Dietrich Reimer)
- Hillenbrand, Robert (1994) *Islamic Architecture: Form, Function and Meaning* (New York: Columbia University Press)
- Hillenbrand, Robert (1999) *Islamic Art and Architecture: The World of Art* (New York: Thames & Hudson)
- Hoag, John D. (1987) *Islamic Architecture* (New York: Electa/Rizzoli)
- Hodgson, Marshall G. S. (1974) *The Venture of Islam: Conscience and History in a World Civilization* (2 vols, Chicago: University of Chicago Press)
- Holod, Renata (1988) 'Text, Plan and Building: On the Transmission of Architectural Knowledge', in Margaret Bentley Sevckenko (ed.) *Theories and Principles of Design in the Architecture of Islamic Societies* (Cambridge, MA: The Aga Khan Program for Islamic Architecture)
- Ibn 'Abd Rabbih (ninth century) (1995) *Addur an-Nadid min al-'Iqd al-Farid*, edited by Mohamed Said al-'Aryān (Damascus: Talas)

- Ibn al-Athīr (d. 630 AH) (1983) *Al-Kāmil* (Beirut: Dar al-Kitāb al-‘Arabi) vol. 1
- Ibn Durayd, Muhammad ibn al-Hasan (d. 321/933) (1970) *Kitāb Jamharat al-Lughah* (3 vols, Baghdad: Al-Muthanna Library)
- Ibn Ishāq, Ḥunain (AD 809–77) (1928) *The Book of Ten Treatises on the Eye*, translated and edited by Max Meyerhof (Cairo: Government Press)
- Ibn al-Jahm Ali (ninth century CE) (1949) *Diwan*, edited by Khalil Marum (Damascus: Al-Majma‘ al-‘Ilmi al-‘Arabi)
- Ibn Khaldun (died CE 1406) (1967) *The Muqaddimah*, 3 vols, translated by Franz Rosenthal (Princeton, NJ: Bollingen Series 43, Princeton University Press, first published 1958)
- Ibn Khaldun (1978) *Discours sur l’Histoire universelle: Al-Muqaddima*, translated into French by Vincent Monteil (Paris: Sindbad)
- Ibn Khaldun (1989) *The Muqaddimah*, abridged version translated by Franz Rosenthal (Princeton, NJ: Bollingen Series, Princeton University Press, first published 1969)
- Ibn Manẓur (690–771 AH) (1994) *Lissan al-‘Arab*, 15 vols (Beirut: Dar Sader)
- Ibn al-Mu‘taz (d. CE 908) (n.d.) *Diwan*, edited by Karam al-Bustani (Beirut: Dar Sader)
- Ibn Qutayba, Abdallah Ibn Muslim (1904) *Kitāb al-Shi‘r wa-l-Shu‘ara*, edited by M. J. de Goeje (Leiden: E. J. Brill)
- Izeddin, M. (1946) ‘Un prisonnier Arabe à Byzance au IXe siècle, Haroun-ibn-Yahya’, *Revue des Etudes islamiques*, vol. 15, pp. 41–62
- al-Jāhiz (d. CE 869) (1970) *Kitāb al-Thaj Fī Akhlāqi al-Mulūk*, edited by Fawzy Attawi (Beirut: Al-Sharika al-Lubnania li al-Kitāb)
- al-Jāhiz (1993) *Al-Bayān wa al-Tabyīn* (4 vols in 2 parts, Expression and Persuasion) (Beirut: Dar Ihya’ al-ulum)
- al-Jāhiz (1996) *Kitāb al-Ḥayawān* (The Book of Animals) edited by Abdeslam Muhammad Harun (7 vols, Beirut: Dar Al Jail)
- al-Jāhiz (2003) *Al-Ma ḥāsin wa-l-aḍḍād* (Beirut: Al-Maktaba al-‘asriya)
- Jakobson, Roman (1960) ‘Closing Statements: Linguistics and Poetics’, in Thomas A. Sebeok (ed.) *Style in Language* (New York: The Technology Press of MIT and John Wiley & Sons, Inc.)
- James, John (1978) *The Contractors of Chartres* (London: Mandorla Publications)
- Jencks, Charles (1978) *The Language of Postmodern Architecture* (York: Rizzoli/International)

REFERENCES

- Johns, Jeremy (1999) 'The "House of the Prophet" and the Concept of the Mosque', in Jeremy Johns (ed.) *Bayt al-Maqdis: Jerusalem and Early Islam* (Oxford: Oxford University Press) pp. 59–112
- Johns, Jeremy (ed.) (1999) *Bayt al-Maqdis: Jerusalem and Early Islam* (Oxford: Oxford University Press) pp. 59–112
- al-Khalil, Ibn Ahmad (718–86?) (1984) *Kitāb al-'Ayn*, edited by Mahdi Makhzoumi and Ibrahim as-Samarra'i (8 vols, Baghdad: Dar ar-Rachid)
- al-Khalil, Ibn Ahmad (n.d.) *Kitāb al-'Ayn*, edited by 'Abd Allah Darwish (Baghdad: Dā'irat al-Shu'ūn al-Thaqāfiya wa al-Nashr)
- Khoury, Nuha (1993) 'The Dome of the Rock, the Ka'ba, and Ghumdan: Arab Myths and Umayyad Monuments', *Muqarnas*, vol. 10, pp. 57–65
- Khoury, Nuha (1996) 'The Meaning of the Great Mosque of Córdoba in the Tenth Century', *Muqarnas*, vol. 13, pp. 80–98
- Kilito, Abdefattah (1985) *L'auteur et ses Doubles* (Paris: Editions du Seuil)
- King, G. R. D. (1991) 'Cresswell's Appreciation of Arabian Architecture', *Muqarnas*, vol. 8, pp. 94–102
- Kostof, Spiro (ed.) (2000) *The Architect: Chapters in the History of the Profession* (Berkeley: University of California Press, first published 1977)
- Krenkow, F. (n.d.) 'Qaṣīda', in *Encyclopedia of Islam*, vol. 4 (Leiden: E. J. Brill)
- Lacan, Jacques (1973) *Le Séminaire, Livre XI, Les Quatres Concepts fondamentaux de la Psychanalyse* (Paris: Editions du Seuil)
- Lacan, Jacques (1977) 'The Function and Field of Speech and Language in Psychoanalysis', in Jacques Lacan, *Ecrits: A Selection*, translated by Alan Sheridan (New York: W. W. Norton & Company)
- Lacan, Jacques (1978) *Le Séminaire, Livre II, Le Moi dans la Théorie de Freud et dans la Technique de la Psychanalyse* (Paris: Editions du Seuil)
- Leach, Edmund R. (1967) 'Genesis as Myth', in John Middleton (ed.) *Myth and Cosmos* (New York: The Natural History Press)
- Le Goff, Jacques (1978) *Pour un Autre Moyen-Age* (Paris: Gallimard)
- Leonardo da Vinci (1955) *The Notebooks of Leonardo da Vinci*, translated and edited by Edward MacCurdy (New York: George Braziller)

- Lévi-Provençal, E. (1961) *La Civilisation arabe en Espagne* (Paris: Maisonneuve et Larose, first published 1948)
- Lévi-Strauss, Claude (1967) 'Four Winnebago Myths: A Structural Sketch', in John Middleton (ed.) *Myth and Cosmos* (New York: Natural History Press)
- Lévi-Strauss, Claude (1979) *Myth and Meaning* (New York: Schocken Books)
- Lévi-Strauss, Claude (1983) *Structural Anthropology*, translated by Monique Layton (2 vols, Chicago: University of Chicago Press, first published 1976)
- Lévi-Strauss, Claude (1983) 'The Story of Asdival', in Claude Lévi-Strauss, *Structural Anthropology*, translated by Monique Layton (Chicago: University of Chicago Press, first published 1976) vol. 2, pp. 172-3
- Lévi-Strauss, Claude (1983) 'Reflections on a Work by Vladimir Propp', in Claude Lévi-Strauss, *Structural Anthropology*, translated by Monique Layton (Chicago: University of Chicago Press, first published 1976) vol. 2, pp. 137-8
- L'Orme, Philibert de (1988) 'Dedicatoire to the *Traité d'Architecture*', in Philibert de l'Orme, *Les Livres d'Architecture* (Paris: Léonce Laget, Libraire-Editeur, first published 1567)
- Liotard, Jean François (1971) *Discours, Figure* (Paris: Editions Klincksieck)
- Malraux, André (1951) *Les Voix du Silence* (Paris: Gallimard)
- Massignon, Louis (1963) 'Les moyens de réalisation artistiques de l'Islam', in Louis Massignon, *Opera Minora*, vol. 3, edited by Y. Moubarac (Beirut: Dar al-Maarif, first published 1921)
- al-Mas'udi (d. 957 AH) (n.d.) *Murūj Addahab wa Ma'adin al-Jawhar*, edited by Yusuf As'ad Dagher (4 vols in two parts, Beirut: Dar al-Andalus)
- Mayer, L. A. (1956) *Islamic Architects and their Works* (Geneva: Albert Kundig)
- Metcalf, Barbara Daly (ed.) (1996) *Making Muslim Space* (Berkeley: University of California Press)
- Middleton, John (ed.) *Myth and Cosmos: Reading in Mythology and Symbolism* (New York: Natural History Press, 1967)
- al-Mulawwah, Qays ibn (d. AD 690) (1973) *Diwan Majnūn Layla*, edited by Abdassattar Ahmad Farraj (Cairo: Maktabat Masr)

REFERENCES

- al-Muqaddasi (tenth century) (1906) *Kitāb Aḥsan al-Taqāsīm*, edited by M. J. de Goeje (Leiden: E. J. Brill, reprinted by Dar Sader, Beirut)
- Necipoğlu, Gülru (1995) *The Topkapi Scroll: Geometry and Ornament in Islamic Architecture* (Santa Monica: The Getty Center for the History of Art and the Humanities)
- Pandolfo, Stefania (1997) *Impasse of the Angels: Scenes from a Moroccan Space of Memory* (Chicago: University of Chicago Press)
- Panofsky, Erwin (1946) *Abbot Suger on the Abbey Church of St Denis and its Art Treasures* (Princeton, NJ: Princeton University Press)
- Panofsky, Erwin (1985) *Gothic Architecture and Scholasticism* (New York: Meridian, first published 1951)
- Panofsky, Erwin (1955) 'Two Façade Designs by Domenico Beccafumi and the Problem of Mannerism in Architecture', in Erwin Panofsky, *Meaning in the Visual Arts* (New York: Doubleday Anchor Books) pp. 226–35
- Panofsky, Erwin (1955) 'The History of the Theory of Human Proportions as a Reflection of the History of Styles', in Erwin Panofsky, *Meaning in the Visual Arts* (New York: Doubleday Anchor Books)
- Panofsky, Erwin (1993) *La Renaissance et ses Avants-Courriers dans l'Art d'Occident* (Paris: Flammarion)
- Papadopoulo, Alexandre (1979) *Islam and Muslim Art*, translated by Robert Erich Wolf (New York: Harry N. Abrams)
- Perlmann, Moshe (1953) 'A Legendary Story of Ka'b al-Aḥbar's Conversion to Islam', *The Joshua Starr Memorial Volume, Jewish Social Studies*, no. 5, New York, pp. 85–9
- Perlmann, Moshe (1954) 'Another Ka'b al-Aḥbar Story', *Jewish Quarterly Review*, vol. 45, no 1, pp. 48–51
- Protzen, Jean-Pierre (1981) 'Reflections on the Fable of the Caliph, the Ten Architects and the Philosopher', *Journal of Architectural Education*, vol. 34, no. 4, pp. 2–8
- Qur'an, The Holy (1987) translation and commentary by Abdullah Yusuf Ali (New York: Tahrike Tarsile Qur'an, Inc.)
- Rabbat, Nasser (1989) 'The Meaning of the Umayyad Dome of the Rock', *Muqarnas*, vol. 6, pp. 11–21
- Rabbat, Nasser (1993) 'The Dome of the Rock Revisited: Some Remarks on al-Wasiti's Accounts', *Muqarnas*, vol. 10, pp. 67–75

- Rice, David Talbot (1934) 'The Oxford Excavations at Hira', *Ars Islamica*, vol. 1, pp. 51–73
- Sauvaget, Jean (1934) 'Esquisse d'une Histoire de la Ville de Damas', *Revue des Études islamiques*, vol. 8, pp. 421–80
- Sauvaget, Jean (1947) *La Mosquée omeyyade de Médine* (Paris: Vanoest)
- al-Sayyad, Nezar (1991) *Cities and Caliphs: On the Genesis of Arab Muslim Urbanism* (Westport: Greenwood Press)
- al-Shāfiī (150–204 AH) (1996) *Al-Kitāb al-Umm* (24 vols, Beirut: Dar Qutayba)
- al-Shirazi, Mohammed Hussin (1980) *Tafsir Taqrib al-Qur'an ilā al-Adhān* (10 vols, Beirut: Mu'assassat al-Wafā)
- Sourdel, Dominique and Janine (1983) *La Civilisation de l'Islam classique* (Paris: Les Editions Arthaud)
- Summerson, John (1963) *The Classical Language of Architecture* (Cambridge: MIT Press, first published 1947)
- Tabari (AD 839–923) (1991) *Tārīkh*, 6 vols (Beirut: Dar al Kutub al-ʿIlmiya)
- al-Thaʿālibi (350–429 AH) (1990) *ʿAdāb al Mulūk*, edited by Dr Jalil al Athia (Beirut: Dar al-Gharb al-Islāmi)
- Tonna, Jo (1990) 'The Poetics of Arab-Islamic Architecture', *Muqarnas*, vol. 7, pp. 182–97
- Valéry, Paul (1963) 'Mémoires d'un Poète', in Paul Valéry, *Oeuvres Complètes* (Paris: Editions Gallimard)
- Venturi, Robert (1990) *Complexity and Contradiction in Architecture* (Michigan: University of Michigan Press)
- Viollet-le-Duc, Eugène (1854–69) *Dictionnaire raisonné de l'Architecture française du XIe au XVe siècle* (10 vols, Paris: A. Morel)
- Vitruvius (1960) *The Ten Books on Architecture*, translated by Morris Hicky Morgan (New York: Dover Publications, Inc.)
- von Bothmer, Hans-Gaspar Graf (1988) 'Masterworks of Islamic Book Art: Koranic Calligraphy and Illumination in the Manuscripts found in the Great Mosque in Sanaa', in Werner Daum (ed.) *Yemen: 3000 Years of Art and Civilization in Arabia Felix*, (Innsbruck: Pinguin-Verlag) pp. 178–81
- Von Grunebaum, G. E. (1966) *Medieval Islam: A Study in Cultural Orientation* (Chicago: University of Chicago Press)
- Von Grunebaum, G. E. (1970) *Classical Islam: A History, 600 AD–1258 AD*, translated by Katherine Watson (Chicago: Aldine Publishing Company)

REFERENCES

- Weil, Gotthold (n.d.) ‘Arūd’, in *Encyclopedia of Islam*, vol. 1 (Leiden: E. J. Brill) pp. 667–77
- Wellhausen, J. (1927) *The Arab Kingdom and its Fall*, translated by Margaret Graham Weir (Calcutta: University of Calcutta Press)
- Whelan, Estelle (1986) ‘The Origins of the Miḥrab Mujawwaf: A Reinterpretation’, *International Journal of Middle East Studies*, vol. 18, no. 2, pp. 205–23
- Wittgenstein, Ludwig (1984) *Culture and Value*, translated by Peter Winch (Chicago: University of Chicago Press, first published 1977)
- Wittkower, Rudolf (1971) *Architectural Principles in the Age of Humanism* (New York: W.W. Norton & Company)
- Yaqubi (d. CE 897) (1992) *Tārīkh al-Ya’qubi*, 3 vols (Beirut: Daar Saadir)
- Zevi, Bruno (1978) *Architecture as Space: How to Look at Architecture*, translated by J. A. Barry (New York: Horizon Press)
- Zevi, Bruno (1978) *The Modern Language of Architecture* (Seattle: University of Washington Press)

Index

- ‘Abbasid, 3, 22, 24, 27, 34,
59, 77–9, 93, 99, 103, 105,
109, 115, 117, 119, 121,
126, 156, 160, 162–3, 186,
190, 198, 230, 231, 233–4;
‘Abbasids, 57, 170, 180,
184–5
- ‘Abd-Allah, 49, 54–5
- ‘Abdallah b. Qilabah, 151
- Abi ‘Abd Manāf, 52
- Abi-Khukh, 51
- al-Abraq, 56–7
- Abu al-‘Aynā’, 203, 205, 211
- Abu Bakr al-bannā’, 195
- Abu Dulaf Mosque, 109,
115, 117, 119
- Abu ‘Inān, 194
- Abu-Bakr, Caliph, 175
- Abyssinia, 107
- Achaemenid Apadana, 108
- ‘Ād b. ‘Us b. Iram, 150, 152,
154, 156
- ‘Addiy bnu Zaid al ‘Ibadi,
146
- Aden, 150
- Adonis, 57, 77
- Adorno, Theodor, 10–11,
18, 20
- aesthetics, 10, 17, 20, 28,
33–4, 46, 77–8, 85, 159,
163
- Afghanistan, 5
- Aga Khan Foundation, 6
- Aguedal, 20
- Ahmad b. Muhammad,
194
- al-Aḥmar, Khalaf, 80
- al-Aḥnaf, 217
- Akbar, Jamel, 199
- Akhbār al-‘abbasiyin,
204
- Albert-Birot, Pierre, 89
- Alexander, 41, 108
- Alhambra, 105
- Ali, Caliph, 184
- Allen, Terry, 186
- Andalusia, 55, 78;
Andalusian, 2, 20, 51, 55,
74
- Annajaf, 145
- Annu‘mān, King, 136–7, 140,
144–8
- al-‘aqd, 58–9, 61, 70
- Aqqa, 195
- Aqsa Mosque, 93, 109, 185
- Arabia, 53, 130–2, 148–9,
166
- ‘Arafāt, 225
- Ardalan, 189
- Ardashīr, 36
- Aristotle, 19, 38, 42
- Armenia, 149

- al-ʿarūd*, 29, 69–70, 74, 77–8,
 85
 al-Asfahāni, 141–4, 147–8
 Ash-sham, 148, 167
 ash-Shuʿūb, 57
ash-shuʿūbiya, 98
 al-ʿAskari, Abū Hilal, 82
 al-Aṣmaʿi, 70, 82, 83
 Assadir, 147
 Atlantic Ocean, 106, 149,
 152
attawḥīd, 20
 Attubbat, 149
 al-Azhari, Muhammad Ibn
 Ahmad, 194, 200

 Bachelard, Gaston, 23, 89,
 227
 Baer, Eva, 92–3, 98
 Baghdad, 59, 204
 Bayt al-māl, 95
 Bakhtiar, 189
 Balkuwara, 121
 Balkuwara Palace, 121, 216
 Bamiyan, 5
 Baroque, 3
 Barthes, Roland, 8, 12, 139,
 191
 Barzun, Jacques, 68
 Basra, 35, 78, 186
 Bataille, Georges, 16, 229
 Bateson, Mary Catherine,
 80, 85, 102
 Batn Nakhl, 177
al-bayān, 28, 31, 33–40, 42,
 44–5, 47, 55–9, 61, 69–70,
 201, 230–1, 233

 Bedouins, 102, 180;
 bedouinism, 78
 Belqis, King, 226
 Bencheikh, Jamal Eddine,
 81–2
 Bloch, Ernst, 189–90
 Bloom, Jonathan M., 196–7
 Bohr, Niels, 68
 Bordeaux, 213
 Bourdieu, Pierre, 68
 Buhram Gur, 140
 Bukhara, 58
Bulāṭ al-Walīd, 172, 184
 Burckhardt, Titus, 189
 Byzantine, 3, 61, 98, 129,
 136–7, 139, 142–3, 161,
 165–7, 174, 214, 216;
 Byzantines, 14, 159, 162,
 166, 174; Byzantine
 Empire, 140

 Cairo, 95, 115, 117, 119, 197
 Caspian Sea, 106
 Cézanne, Paul, 64
 Chebʿa, Mohammed, 63–4
 Christianity, 165, 186, 216;
 Christians, 49, 165–6,
 174, 176
 Cistercian order, 185
 Cité Radieuse, 213, 214
 Constantinople, 59–61
 Coptic, 98
 Córdoba, 6, 115, 117, 197
 Creswell, K. A. C., 3, 24, 100,
 115–16, 121, 126, 130,
 197, 216–17
 Ctesiphon, 36

- Cyprus, 167
- Damascus, 3, 6, 36–7, 49,
53–4, 59–60, 94, 95–6,
105, 107–9, 114–15, 125,
150–1, 159,
162–4, 166–8, 170–3, 175,
177, 179, 183–6, 197, 210,
221, 225, 229, 231
- Darwish, ‘Abd Allah, 77
- de Certeau, Michel, 234
- Dhu al-Qarnain, 156
- Dome of the Rock, 22, 94–5,
98, 125, 132, 163, 165,
197
- Dunyā, 155
- Eco, Umberto, 1, 10, 50
- Ecochard, Michel, 125
- Egypt, 92, 194; Egyptian, 96,
106, 133–4
- Empson, Sir William, 17
- Escher, M. C., 64, 96
- Ettinghausen, Richard, 22,
190
- Euphrates, 144–5
- Fadak, 182
- Fakhita, 55
- Far East, 149, 152
- al-Farabi, 82
- al-Farazdaq, 82
- Fatima, 182
- Fatimid, 119
- Fes, 2, 105
- Foucault, Michel, 46, 224
- Fowden, Garth, 69
- Francastel, Pierre, 68
- France, 3, 5, 60, 214
- Freud, Sigmund, 201–2,
207–9, 234
- Gautier-van Berchem,
Marguerite, 174
- gaze, 32, 48, 81, 192, 203,
209–11, 214–15, 217–21,
223, 226, 233
- gharā’iz*, 45
- Ghumdān, 36, 56–7, 149,
170
- Goldziher, Ignaz, 26
- Gombrich, E. H., 64
- Gothic, 66, 68, 102–3, 211,
213–14; architecture, 3,
63, 67–8; illumination, 68
- Goya, 207
- Grabar, Oleg, 2, 4, 7–9, 16,
18, 20, 66–7, 87–8, 91–2,
94, 96–8, 101, 108, 123,
126, 131, 160–1, 163, 165,
185, 189–90, 192, 216,
228–30, 234
- Hagia Sophia, 98
- al-Ḥajjāj, 171, 181
- al-ḥāl*, 40–1, 58–9, 61, 231
- Halévy, Jean, 133–4
- al-Hamadhāni, 29, 59, 130,
132, 150–3, 156, 218, 226
- Hamilton, R. W., 124
- Hanṭala Ibn Ash-sharqi, 133
- al-Ḥarām, Masjid, 175–7
- Haroun, 59–61
- Ḥaywa, Rajā Ibn, 179

- Heliopolis, 133
 Herzfeld, Ernst, 91, 121
 Hicham Ibn 'Abd al-Malik, 179
 Hillenbrand, Robert, 2, 9–10, 18, 103–4, 114, 121–2, 126, 189
 al-Ḥīra, 126, 136–7, 140, 144, 147
 Hoag, John, 116
 Holod, Renata, 196
horror vacui, 94, 95
 Ḥusain Ibn Ali, 207

 Ibn 'Abd Rabbih, 51–3, 74, 78, 229
 Ibn Abīhi, 171
 Ibn 'Āmir, 57, 170
 Ibn Athīr, 148
 Ibn Durayd, Muhammad ibn al-Hasan, 77, 200
 Ibn Ishāq, 221–4
 Ibn al-Jahm Ali, 31–2, 121, 203, 205, 211, 214–17
 Ibn Khaldun, 16, 82, 90, 150–1, 172, 184
 Ibn Manẓur, 80–1
 Ibn al-Mu'taz, 217
 Ibn Qutayba, 63, 82–3, 85–6, 91, 120, 128
 Ibn Tulun, 95, 115, 117, 195, 197
 'īlal, 101, 125, 127
 India, 106, 167
 Iram, 149–53
 Iran, 3, 197; Iranian, 2, 106; *see also* Persia

 Iraq, 59, 98, 103, 108, 116, 154, 161, 179, 181
 Irving, Washington, 190
 Ishāq, Ḥunain ibn, 24, 32
ishāra, al-, 40, 42–4, 58
 Istabulat, 122
 Istakhr the White, 36

 Jabal Shamam, 150
 Ja'far, 'Abd Allah ibn, 54
 al-Ja'fariyya, 207
al-jāhiliyya, 29, 58, 132
 al-Jāḥiẓ, 33, 24, 26, 28, 30–1, 33–42, 44–50, 52–3, 55–8, 61, 69–70, 74, 77, 79, 84, 87, 89–91, 93, 97, 100, 119, 129, 136–4, 148, 159, 161–4, 167, 170, 183–6, 201, 210, 217, 220, 229–31
 Jakobson, Roman, 16–17, 64, 66, 229
 James, John, 213
 al-Jarrāḥ, 181
 al-Jazari, 95
 Jerusalem, 59, 93, 109, 125, 163, 171, 176
 Jewish, 1–2, 153; Judaism, 216
 Johns, Jeremy, 109

 Ka'b al-Aḥbar, 151, 153
al-kalām, 38
 al-Kalbiyu, 129
 al-Khadra, 184
 Khalid Ibn Safwān, 148

- al-Khalil, Ibn Ahmad, 29,
31, 47, 69–74, 76–9,
83–4, 98, 101, 199–200,
231
- Kharidjis, 180
- al-khāṣṣa*, 43
- al-khaṭ*, 40–1, 43–5, 58, 231
- al-Khattab, ‘Umar Ibn,
175–6, 178
- al-Khawarnaq, 129, 133,
136–7, 140–8
- Khirbat al-Mafjar, 8, 14, 88,
93, 95, 124
- Khirbat Minyah, 126
- Khoury, Nuha N. N., 132
- Khurasan, 181
- Khusrau, 191
- Kilani, Amir, 59
- Kilito, Abdefattah, 81
- King, G. R. D., 130
- Kitāb al-Aghāni*, 141
- Kitāb al-‘Ayn*, 77
- Kitāb al-Ḥayawān*, 34–5,
37–8, 136
- Kostof, Spiro, 197
- al-Kufa, 108, 154, 171
- l’Orme, Philibert de, 19
- Lacan, Jacques, 202, 208–9,
212; Lacanian, 210, 212,
226
- al-laḥẓ*, 40, 43–5, 58, 231
- Lakhmid, 136, 140
- Layla, Majnūn, 26, 65
- Le Corbusier, 13, 213–14
- Le Goff, Jacques, 25
- Leach, Edmund R., 149
- Leonardo da Vinci, 201–2,
208–9, 223
- Lévi-Strauss, Claude, 134–6,
139
- Lisān al-‘Arab, 73
- Loos, Adolf, 211
- Luqman, 156
- al-Madīna, 53–4, 105, 107–9,
114, 123, 166, 171–2,
177–8, 182–3, 185–6, 195
- Madinat al-Salam, 195
- Madīnat-al-Zahra, 115
- Madrasa Abou ‘Ināniya, 105
- Maghrib, 107, 149, 152, 167;
Maghribi, 106–7
- Magritte, René, 64
- Mahāreb, 149, 152
- Mahārib Ghumdān, 132
- Mahārib Suleyman, 132
- Malevich, Kasimir, 5, 95
- al-Malik, ‘Abd, 22, 163, 173,
178
- al-Malik, Hisham Ibn ‘Abd,
148
- al-Malik, Yazid Ibn ‘Abd,
179
- Malraux, André, 207
- Mamluk, 194
- al-Māmūn, Caliph, 22, 79,
234
- Mannerists, 12
- al-Manṣur, 195, 204
- Marçais, Georges, 18, 106
- Ma’rib, 56–7
- Mārid, 36, 57
- Marrakech, 20

- Marseilles, 213–14
Mā-Sarjawayh, 51
Mashreq, 149
Massignon, Louis, 20–1, 67,
 106, 189
Masūdi, 32, 163, 184, 206,
 210
Mayer, L. A., 193–4
Mecca, 107, 175–8, 225
Mediterranean, 8
Michelangelo, 11
Middle Ages, 30, 161
Minā, 225
Minya, 100
Moghul, 2
Mondrian, Piet, 5, 95
Moorish, 3
More, Thomas, 60–1
Morocco, 1–2, 5–6, 106, 155
Mshatta, 14, 100, 103,
 121–2, 126
Mu‘awiya, Caliph, 53–5, 57,
 123, 151, 153–4, 170,
 181–2, 184, 186
Muhammad, Prophet, 25,
 129, 132, 151, 180
Muhammad b. Qalāwūn,
 194
Muqaddasi, Caliph, 15, 115,
 163–8, 171–2, 195, 216,
 224–5
Muqaddimah, 150
al-Muqaffa‘, ‘Abd-Allah Ibn,
 49
al-Mushaqqir, 56
al-Mutannabbi, 30
al-Mu‘tasim, 224
al-Mutawakkil, Caliph,
 31–2, 35, 121, 126, 203–7,
 210–11, 214, 216, 224,
 233
Mu‘tazilī, 35
Najrān, 36, 56, 58
Nāshir al-Ni‘am, King, 226
Nasr, Seyyed, 189
al-Nazzām, 79, 83
Near East, 8, 80
Necipoğlu, Gülru, 4
Nilometer, 194
Nuwās, Abu, 79–81,
 83–4
Ottoman, 2, 12, 107
Ottoman Empire, 194
Palestine, 57, 170
Panofsky, Erwin, 29–30, 63,
 66–70, 79, 84, 99, 101, 161,
 231
Papadopoulos, Alexandre,
 20, 22, 87
Pellat, Charles, 35
Persia, 58, 139–40, 161, 167,
 170, 210; Persian, 36, 49,
 53, 84, 98–9, 108, 133,
 140, 143, 146, 170, 210,
 214, 216; Persians, 36, 53,
 56, 89, 137, 140, 151, 170;
 see also Iran
Pessac, 213
Planck, Max, 68
Plato, 19, 51, 210
Poe, E. A., 40

- Popper, Karl, 227
 Qasr al-‘āshiq, 121
 Qasr al-Ḥayr East, 93
 Qasr al-Ḥayr West, 126
 Qayrawān, 14, 56, 109,
 114–15, 117, 197
 Qubayb, 171, 178, 182
 Qubayb Ibn ‘Abd Allah Ibn
 Azzubayr, 173
 Quṣayr ‘Amra, 69, 163

 Rabat, 1–2
 Rabbat, Nasser, 18, 163
 ar-Rahā, 56
 ar-Rahman III, ‘Abd, 115
 al-Rashid, Harun, 84
 Rauda, 194
 Renaissance, 3, 11, 17, 30,
 161
 Ribat of Susa, 126
 Riddah, 176; Riddah war,
 175
 al-Rimma, Dhu, 82
 Rococo, 3
 Roman Temenos, 107, 114
 Romanesque, 3
 Rusteh, Ibn, 61

 Safavid, 3
 Saint Bernard, 60, 185, 211
 Samarkand, 56, 149, 183
 Samarra, 91, 93–7, 99, 109,
 114–17, 119, 121, 197,
 224–5
 San‘ā, 198
 sariqa, 82–3, 126

 Sasanian Empire, 140, 142;
 Sasanian, 49, 92, 98–9,
 123, 137–8, 140, 142–3,
 145–6, 148, 161;
 Sasanians, 140
 Saudi Arabia, 6, 52
 Sauvaget, Jean, 107
 al-Ṣayyad, Ibn, 54
 scholasticism, 68, 79
 Shaddād, 148–56
 Shaddād ibn ‘Ād, 150
 Shadīd, 150
 al-Shāfi‘ī, 32, 218–20, 223
 al-Sham, 149
 Shammar Yu‘rish, 226
 Shī‘a, 180
 Sinimmār, 22, 129, 133,
 136–9, 141–9, 151, 157,
 229
 Siraf, 197
 Solomon, King, 22, 217, 226
 Spain, 80, 106, 115, 194
 Sufi, 7, 178, 182–3, 190, 201,
 234
 Sufism, 149, 178, 234
 Suger, Abbot, 60
 Sulayman, Abdu Allah,
 178–9
 Sulayman Ibn Abi Asīrī,
 183
 Summerson, John, 11
 Syria, 57, 98, 133, 165, 170;
 Syrian, 2, 106, 125, 133

 Tabari, 31–3, 40, 137–48,
 150–1, 153–4, 163, 165,
 172–9, 190, 202, 206

- taḍmīn*, 82–3, 123, 126
 Taef, 178
 Taj Mahal, 2, 189
 Taliban, 5
al-taqṭī, 100–1, 128
 al-Tha‘ālibi, 31, 151, 202,
 205, 211, 214, 224, 233
 Thābit, Ḥassān Ibn, 52,
 57
 Tharaud brothers, 20
 al-Ṭirimāh, 82
 Tonna, Jo, 105, 106
 Tunisia, 14
 Ṭuwais, 53

 Ukhaidir, 103, 105, 126
 ‘Umar, Caliph, 53, 55, 109,
 159, 162, 164, 173, 175–9,
 181–3, 186
 ‘Umar II, Caliph, 173, 178,
 180, 183, 185–6, 229
 ‘Umar Ibn ‘Abd al-‘Aziz,
 36–7, 53, 149, 159, 162,
 164–5, 167, 171–4, 178,
 180, 195, 210, 221
 ‘Umar Ibn Lajā‘i, 91
 Umayyad, 3, 6, 14, 18–19, 22,
 24, 27, 30, 34, 37, 53–5, 59,
 65, 69, 93–4, 99–101, 104,
 107, 109, 114–15, 117,
 123–6, 132, 148, 153,
 159–65, 168, 171–2, 174,
 178–86, 190, 194–5,
 229–31, 234; Umayyads,
 24, 55, 57, 60, 79, 98, 163,
 166, 168–71, 179, 180–82,
 184–5, 198

 Umayyad Mosque, 3, 95,
 125
 Umm Salama, 184
 United States, 5
 Usayd, ‘Abd Allah Ibn, 177
 ‘Uthman, Caliph, 53, 57,
 109, 170, 173, 177

 Valéry, Paul, 16–17, 88, 199
 van Berchem, Margaret,
 198
 Venturi, Robert, 18, 229
 versification, 70, 74, 77–8,
 81, 83, 85, 105
 Viollet-le-Duc, Eugène, 23

 al-Walīd, ‘Abd al-‘Aziz Ibn,
 178
 al-Walīd, Caliph, 107, 164,
 166–7, 170–5, 177–8, 184
 al-Waqidi, 176
 Warḍān, Muhammad Ibn
 Ja‘far Ibn Warḍān, 173
 Weil, Gotthold, 76
 Wittgenstein, Ludwig, 227
 Wittkower, Rudolph, 18

 Yaqubi, 144–6, 163–5, 167,
 172, 178–9
 Yazdagird III, King, 137
 Yazdagird Dhu al-Aktaf,
 Emperor, 148
 Yazid Ibn ‘Abd al-Malik,
 Caliph, 182
 Yazid, Caliph, 53, 179
 Yazid III, Caliph, 160, 166,
 168, 184–5, 229

INDEX

Yemen, 130, 149–50, 152–3,
198; Yemeni, 153, 198

al-Zamakhshari, 151

al-Zanādiqa, 49

Zevi, Bruno, 11, 13

ziḥāfāt, 101, 125, 127

Ziyād ibn Abīhi, 31, 53, 57,
154, 170–1, 186, 190–1,
202, 212–13

Zubayda, 84

Zuhayr, Kaʿb ibn, 82–3

Zuhayr ibn Abi Salma,
80

